



US00D585588S

(12) **United States Design Patent**
Alexander et al.

(10) **Patent No.:** **US D585,588 S**

(45) **Date of Patent:** **** Jan. 27, 2009**

(54) **LIGHT FIXTURE**

(75) Inventors: **Clayton Alexander**, Westlake Village, CA (US); **Fernando Pardo**, Moorpark, CA (US); **Brandon S. Mundell**, Thousand Oaks, CA (US)

(73) Assignee: **Journée Lighting, Inc.**, Westlake Village, CA (US)

(**) Term: **14 Years**

(21) Appl. No.: **29/300,902**

(22) Filed: **May 28, 2008**

(51) **LOC (9) Cl.** **26-99**

(52) **U.S. Cl.** **D26/118**

(58) **Field of Classification Search** D26/63,
D26/74, 2, 64, 3, 24, 59, 60, 61, 67, 72, 77,
D26/78, 104, 105, 110, 113, 118, 119, 120,
D26/121, 122, 123, 124, 128, 129, 130, 131,
D26/132, 133, 134, 137, 138, 140, 142, 135,
D26/136; D13/134; 313/113; 362/294,
362/147, 260, 269, 218, 231, 235, 264, 373,
362/547, 221, 219, 217, 220, 368; 439/241,
439/238, 232

See application file for complete search history.

(56) **References Cited**

U.S. PATENT DOCUMENTS

D149,124 S *	3/1948	Hewitt	D26/63
D191,734 S *	11/1961	Daher et al.	D28/19
3,538,321 A *	11/1970	Keller et al.	362/289
3,639,751 A *	2/1972	Pichel	362/261
4,761,721 A *	8/1988	Willing	362/348
D322,862 S *	12/1991	Miller	D26/63
D340,514 S *	10/1993	Liao	D23/377
D383,236 S *	9/1997	Krogman	D26/63

D437,652 S *	2/2001	Uhler et al.	D26/63
D465,046 S *	10/2002	Layne et al.	D26/63
D516,229 S *	2/2006	Tang	D26/2
D527,119 S *	8/2006	Maxik et al.	D26/2
7,111,963 B2 *	9/2006	Zhang	362/294
D541,957 S *	5/2007	Wang	D26/2
D544,110 S *	6/2007	Hooker et al.	D26/2
D545,457 S *	6/2007	Chen	D26/2
2005/0174780 A1 *	8/2005	Park	362/294
2007/0253202 A1 *	11/2007	Wu et al.	362/294
2007/0279921 A1 *	12/2007	Alexander et al.	362/368
2007/0297177 A1 *	12/2007	Wang et al.	362/294

* cited by examiner

Primary Examiner—Freda S. Nunn

Assistant Examiner—Kevin K Rudzinski

(74) *Attorney, Agent, or Firm*—Knobbe Martens Olson & Bear, LLP

(57) **CLAIM**

The ornamental design for a light fixture, as shown and described.

DESCRIPTION

FIG. 1 is front perspective view of a light fixture of our new design;

FIG. 2 is a top view thereof;

FIG. 3 is a bottom view thereof;

FIG. 4 is a right side view thereof;

FIG. 5 is a left side view thereof;

FIG. 6 is a front view thereof; and,

FIG. 7 is a rear view thereof.

The portion of the design depicted in broken lines forms no part of the claimed design.

1 Claim, 6 Drawing Sheets

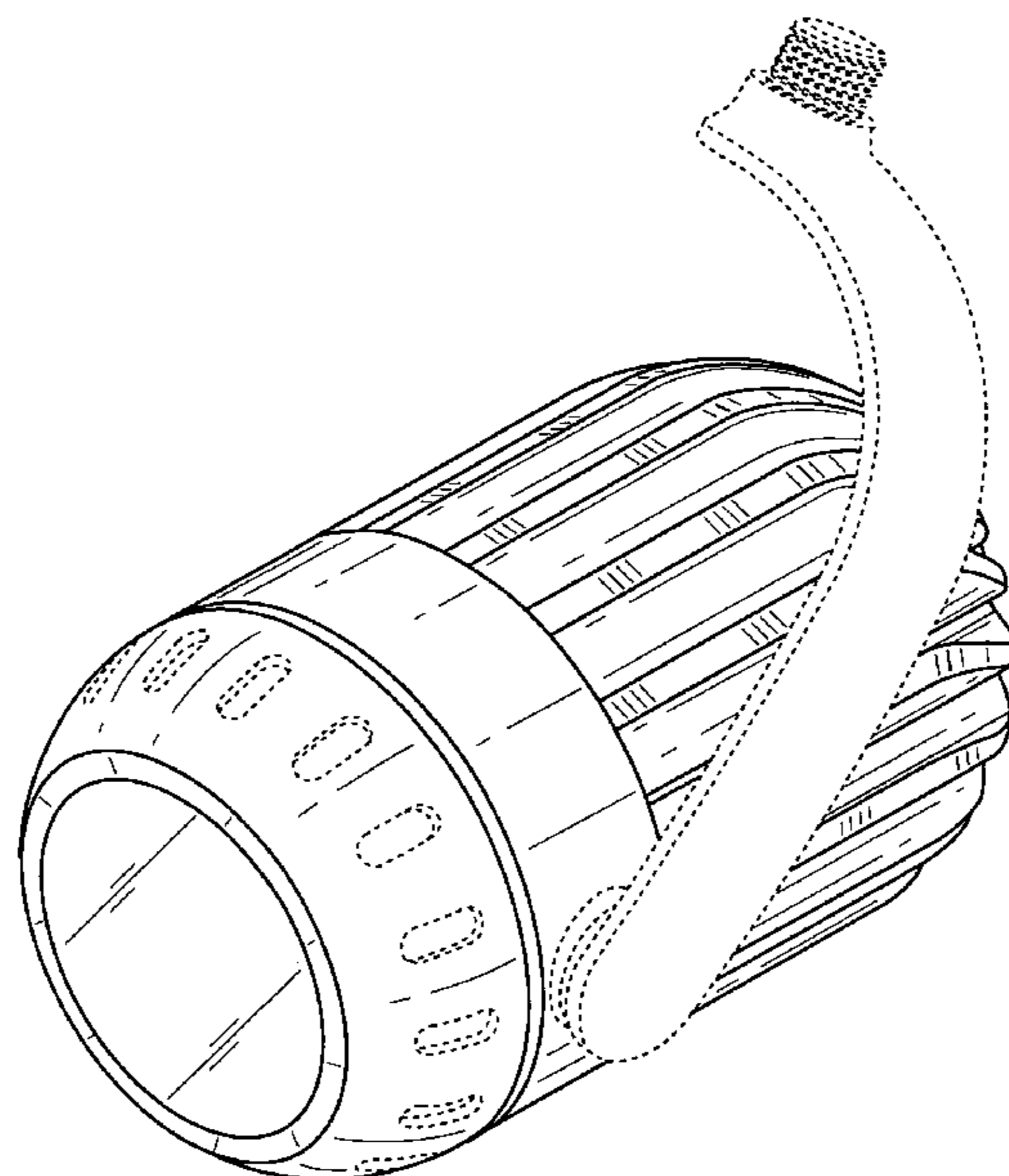

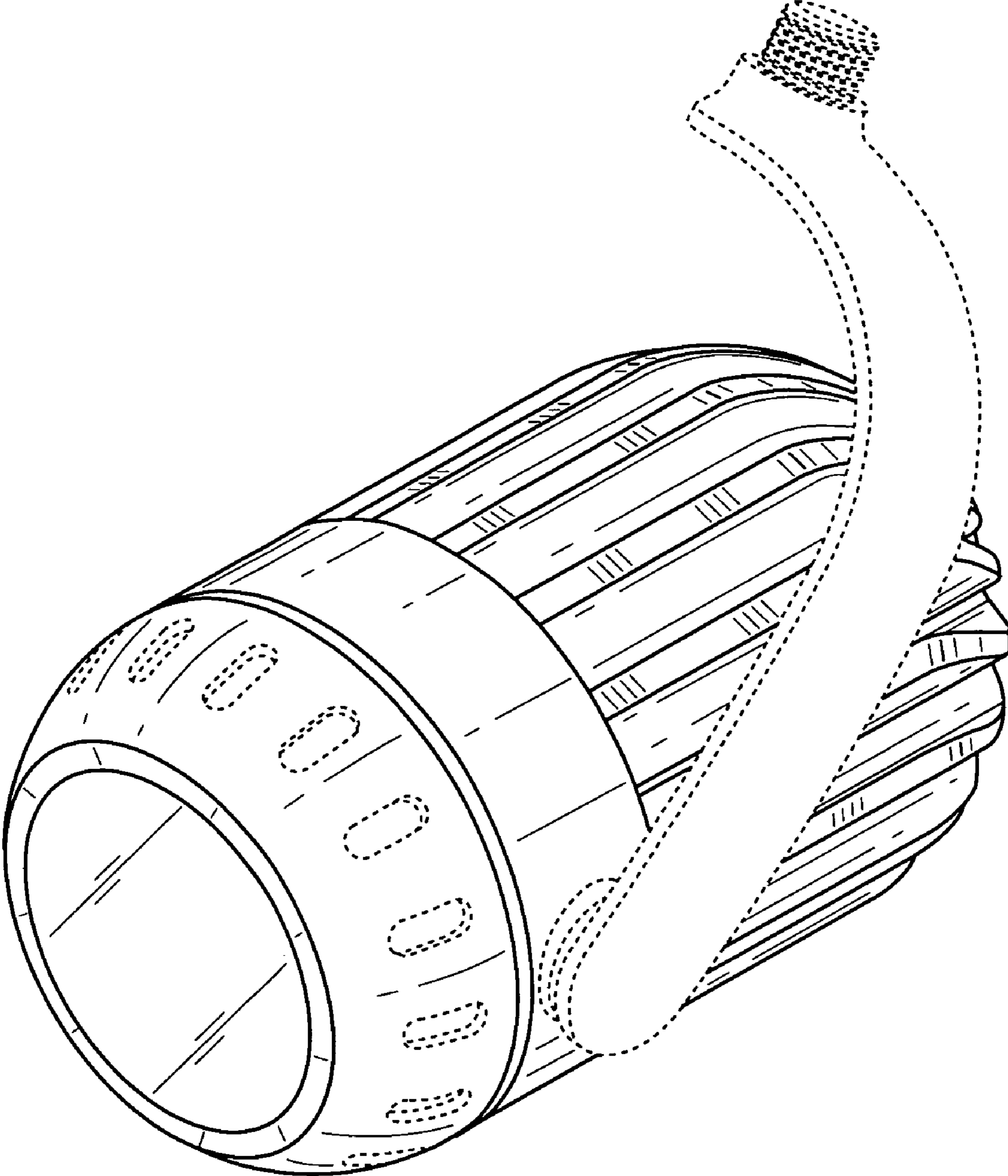

FIG. 1

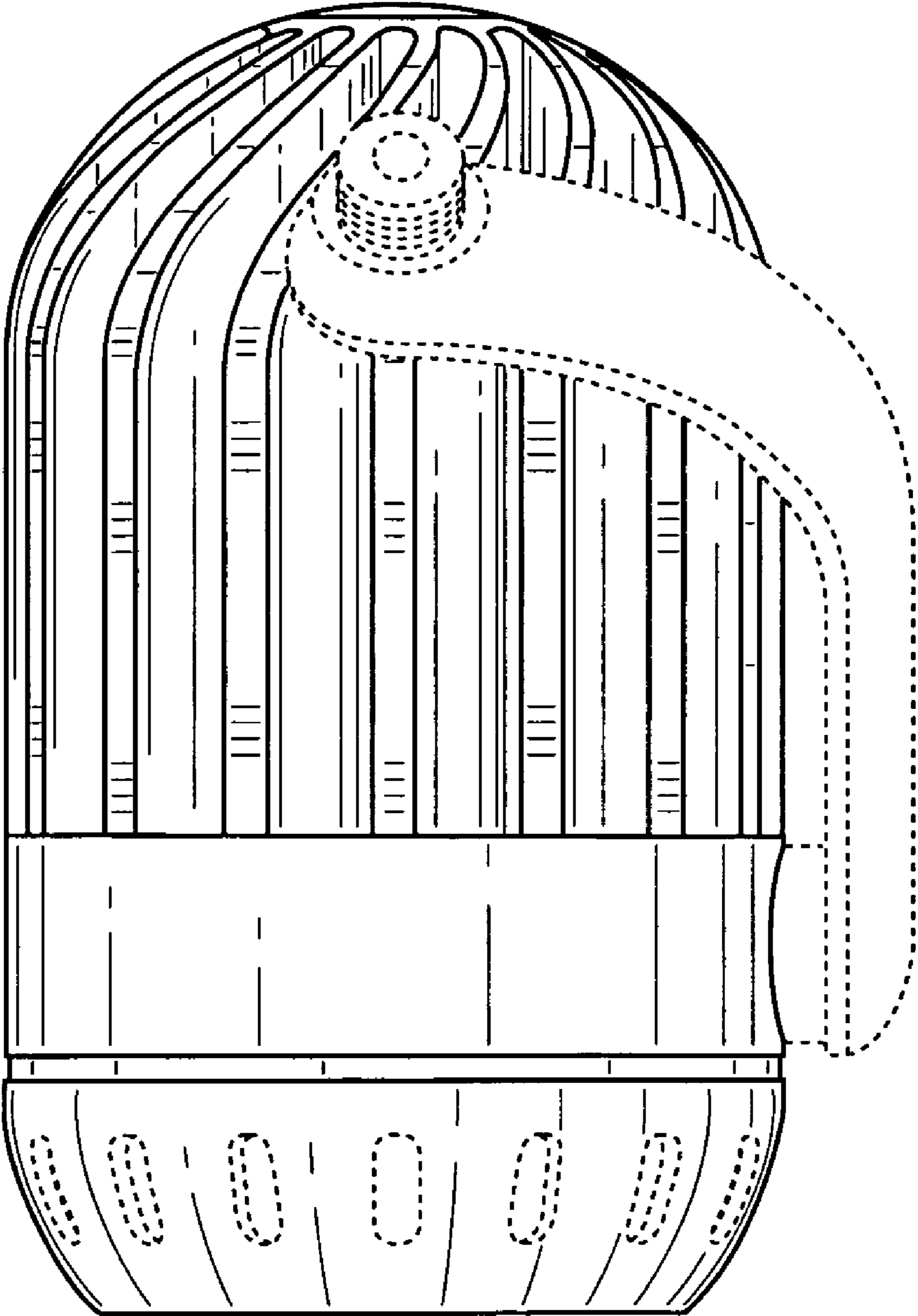

FIG. 2

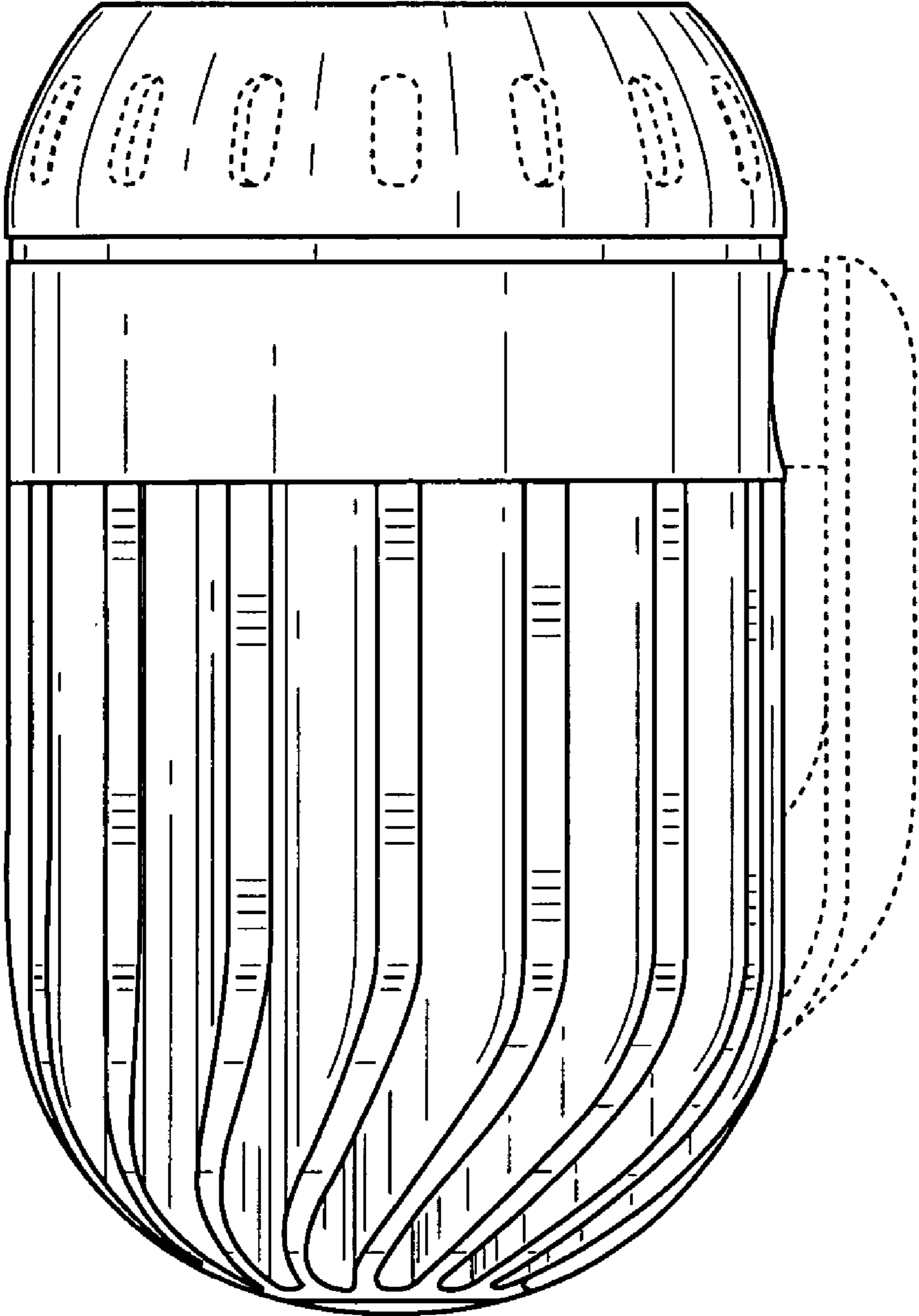

FIG. 3

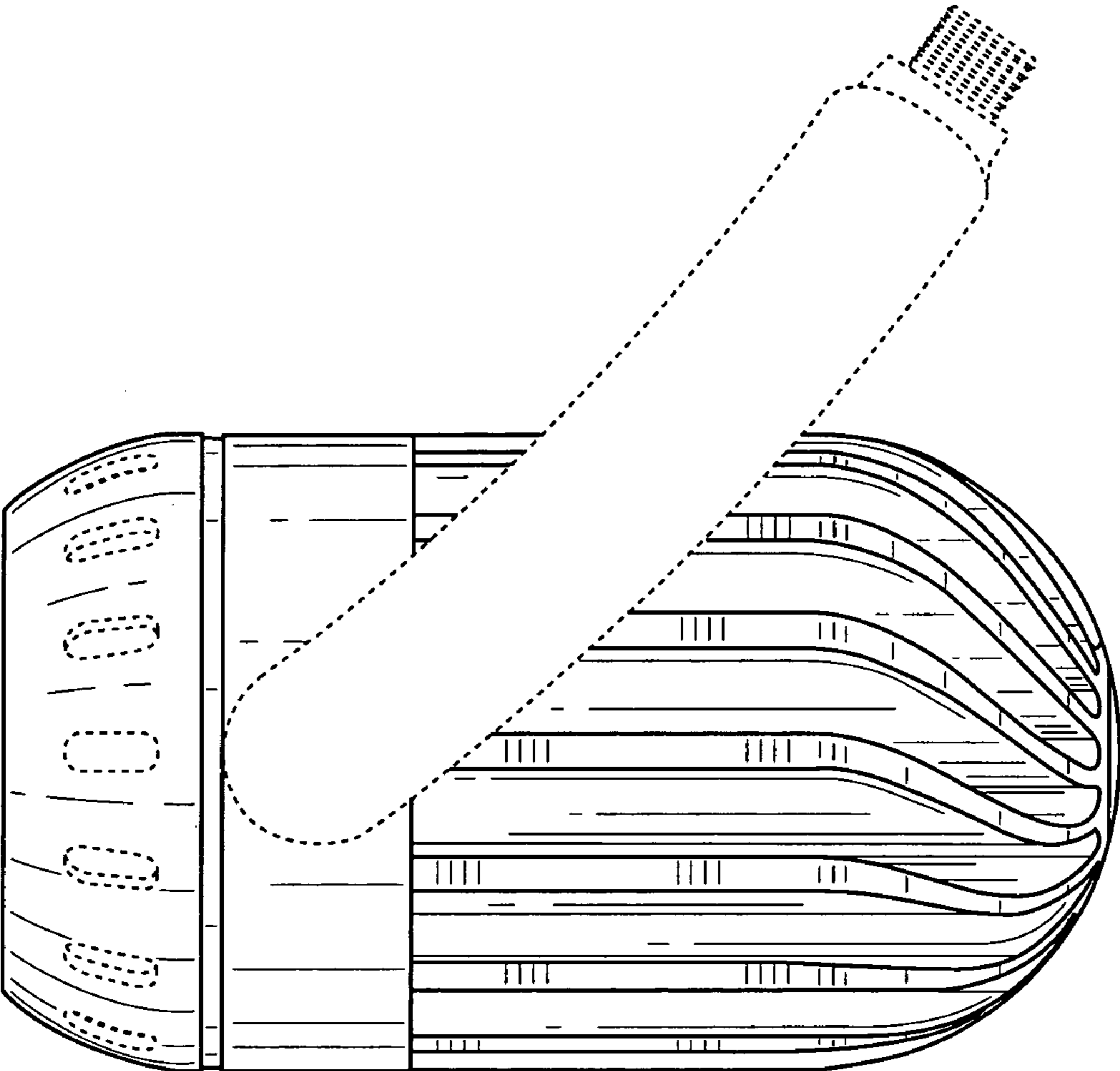

FIG. 4

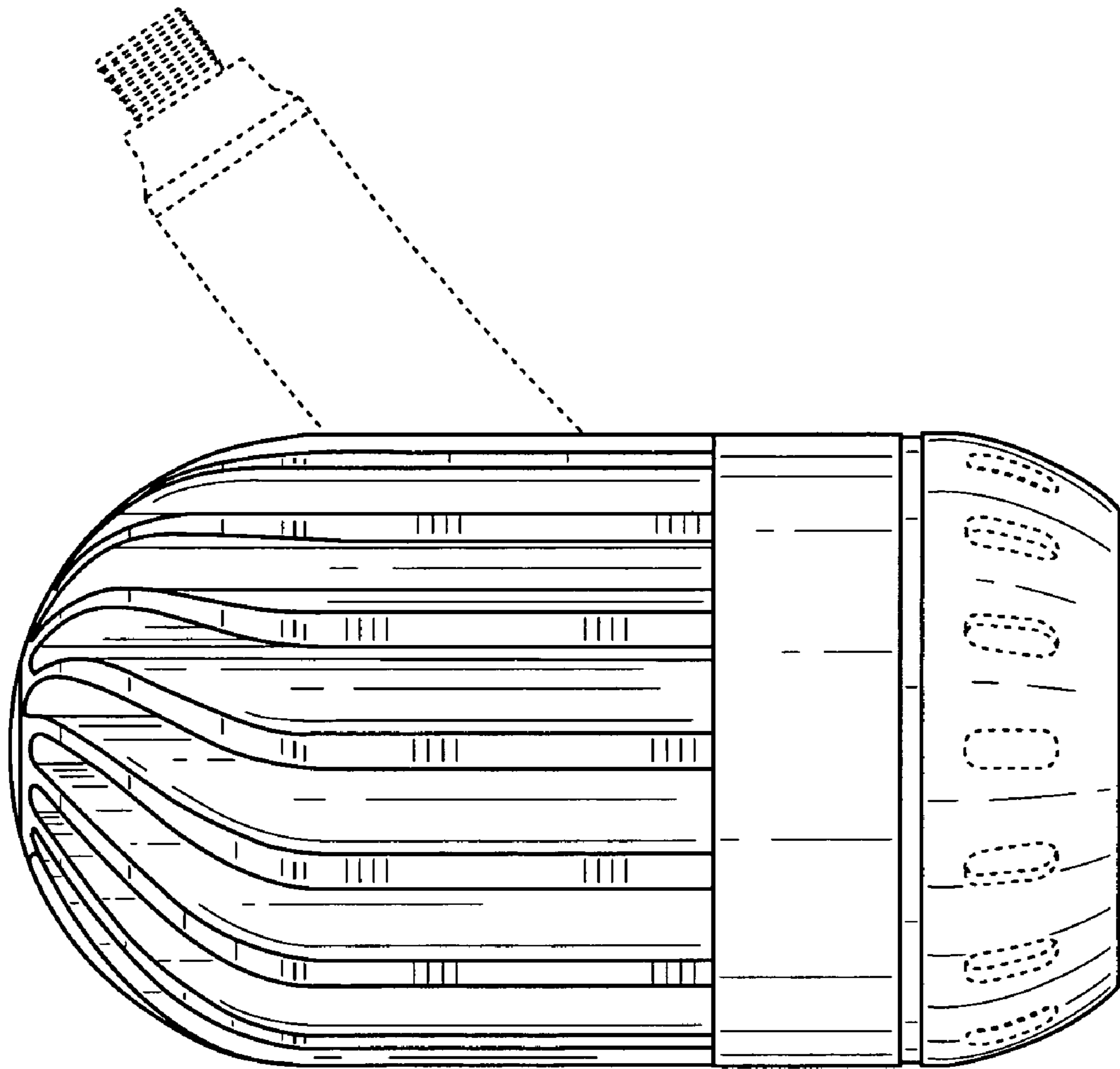

FIG. 5

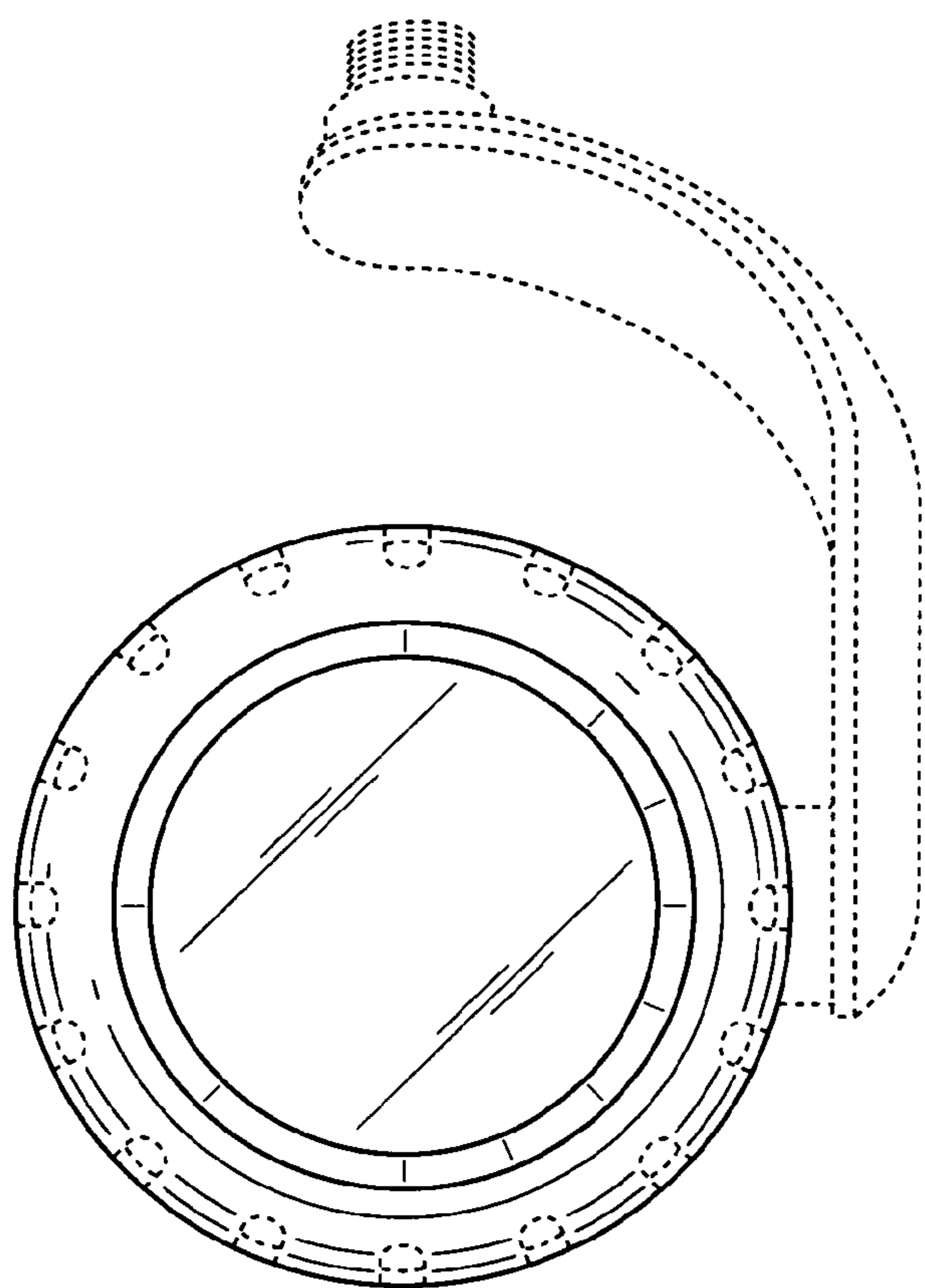

FIG. 6

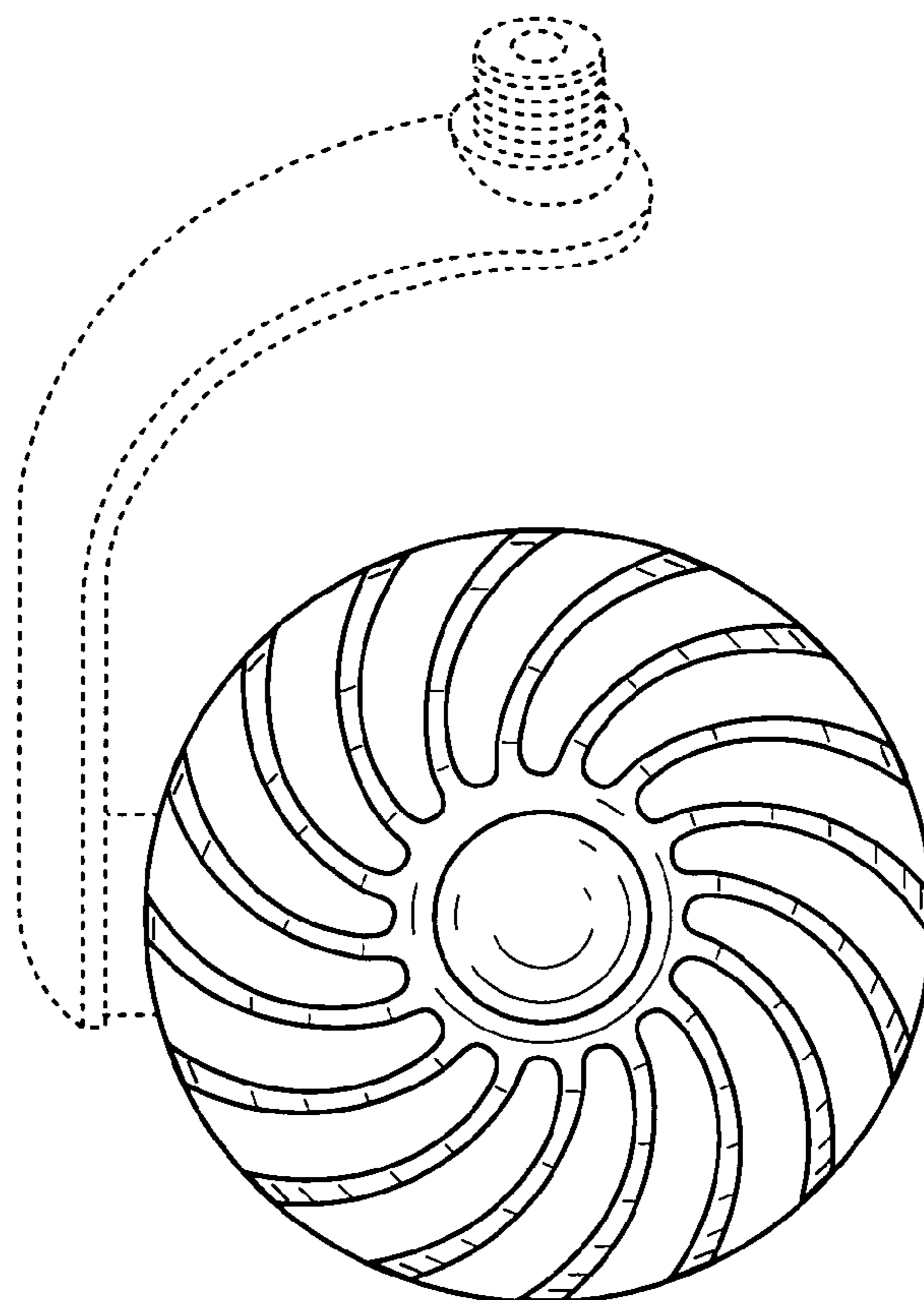

FIG. 7