



US00D585554S

(12) **United States Design Patent**
Suzuki

(10) **Patent No.:** **US D585,554 S**

(45) **Date of Patent:** **** Jan. 27, 2009**

(54) **APPARATUS FOR PHOTOGRAPHING AN ORAL CAVITY**

(75) Inventor: **Koji Suzuki**, Hachioji (JP)

(73) Assignee: **Olympus Corporation**, Tokyo (JP)

(**) Term: **14 Years**

(21) Appl. No.: **29/260,747**

(22) Filed: **May 30, 2006**

(51) **LOC (9) Cl.** **24-01**

(52) **U.S. Cl.** **D24/158; D24/176**

(58) **Field of Classification Search** D24/111,
D24/112, 176, 177, 181, 158; 424/234.1,
424/217.1; 433/89, 86, 80, 119, 98, 26, 24,
433/141, 125; 367/70; 358/521; D16/200,
D16/130, 219; D14/427, 426, 428, 453
See application file for complete search history.

(56) **References Cited**

U.S. PATENT DOCUMENTS

- D240,635 S * 7/1976 Peterson D16/130
- D342,064 S * 12/1993 Harden D14/426
- D456,810 S * 5/2002 Schlieffers D14/428
- D470,497 S * 2/2003 Byun et al. D14/426
- D494,993 S * 8/2004 Uehara et al. D16/219

- D524,835 S * 7/2006 Barman et al. D16/200
- D542,802 S * 5/2007 Woodcock D14/453
- D558,881 S * 1/2008 Kobayashi D24/176
- D562,825 S * 2/2008 Fitch et al. D14/426
- D566,713 S * 4/2008 Ah D14/428
- D570,843 S * 6/2008 Mazzone et al. D14/428

* cited by examiner

Primary Examiner—Charles A Rademaker

(74) *Attorney, Agent, or Firm*—Hogan & Hartson LLP

(57) **CLAIM**

I claim the ornamental design for an apparatus for photographing an oral cavity, as shown and described.

DESCRIPTION

FIG. 1 is a front, top and right side perspective view of an apparatus for photographing an oral cavity showing my new design;

FIG. 2 is a front elevational view thereof;

FIG. 3 is a rear elevational view thereof;

FIG. 4 is a top plan view thereof;

FIG. 5 is a bottom plan view thereof;

FIG. 6 is a right side elevational view thereof; and,

FIG. 7 is a left side elevational view thereof.

1 Claim, 7 Drawing Sheets

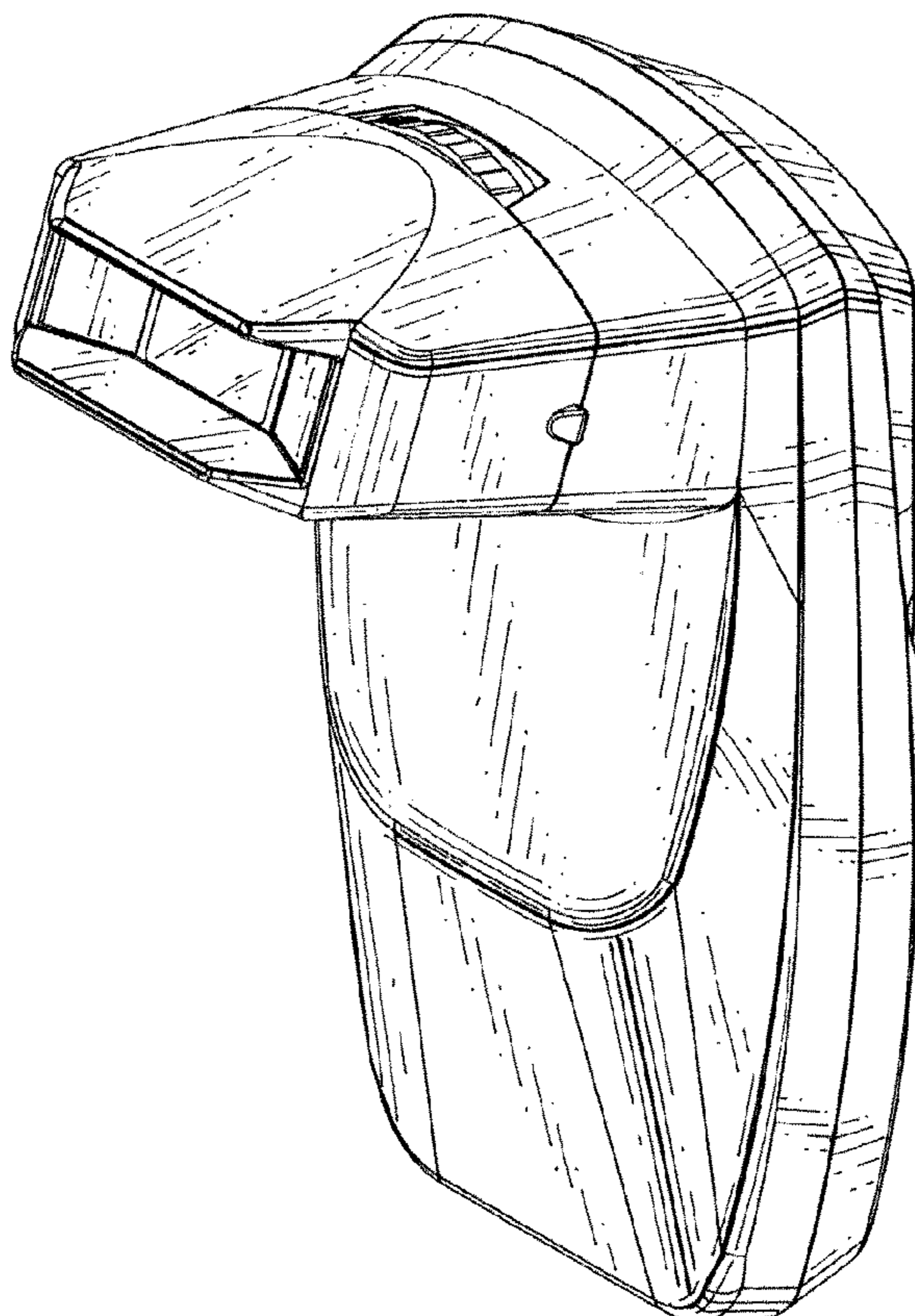

FIG. 1

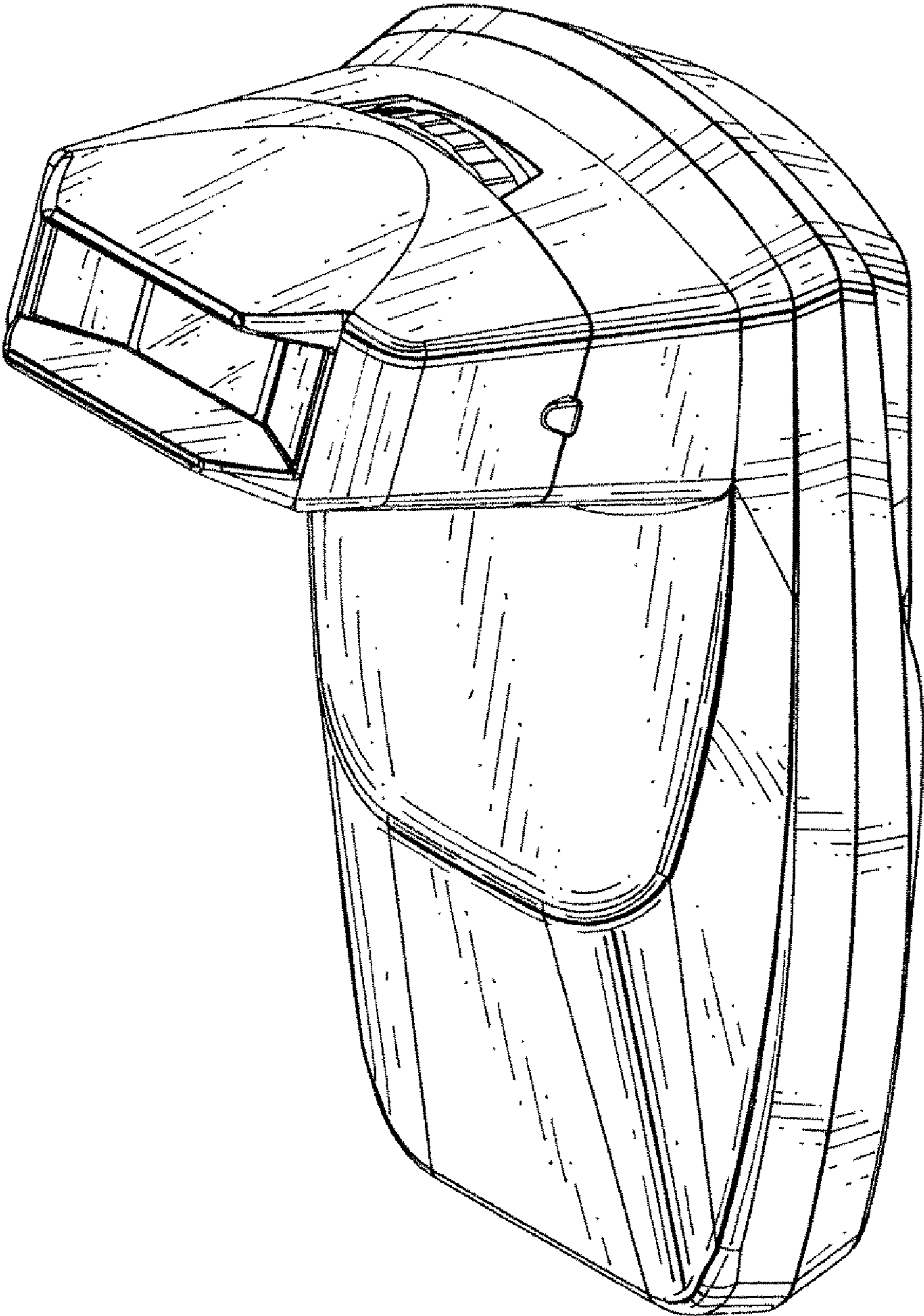

FIG. 2

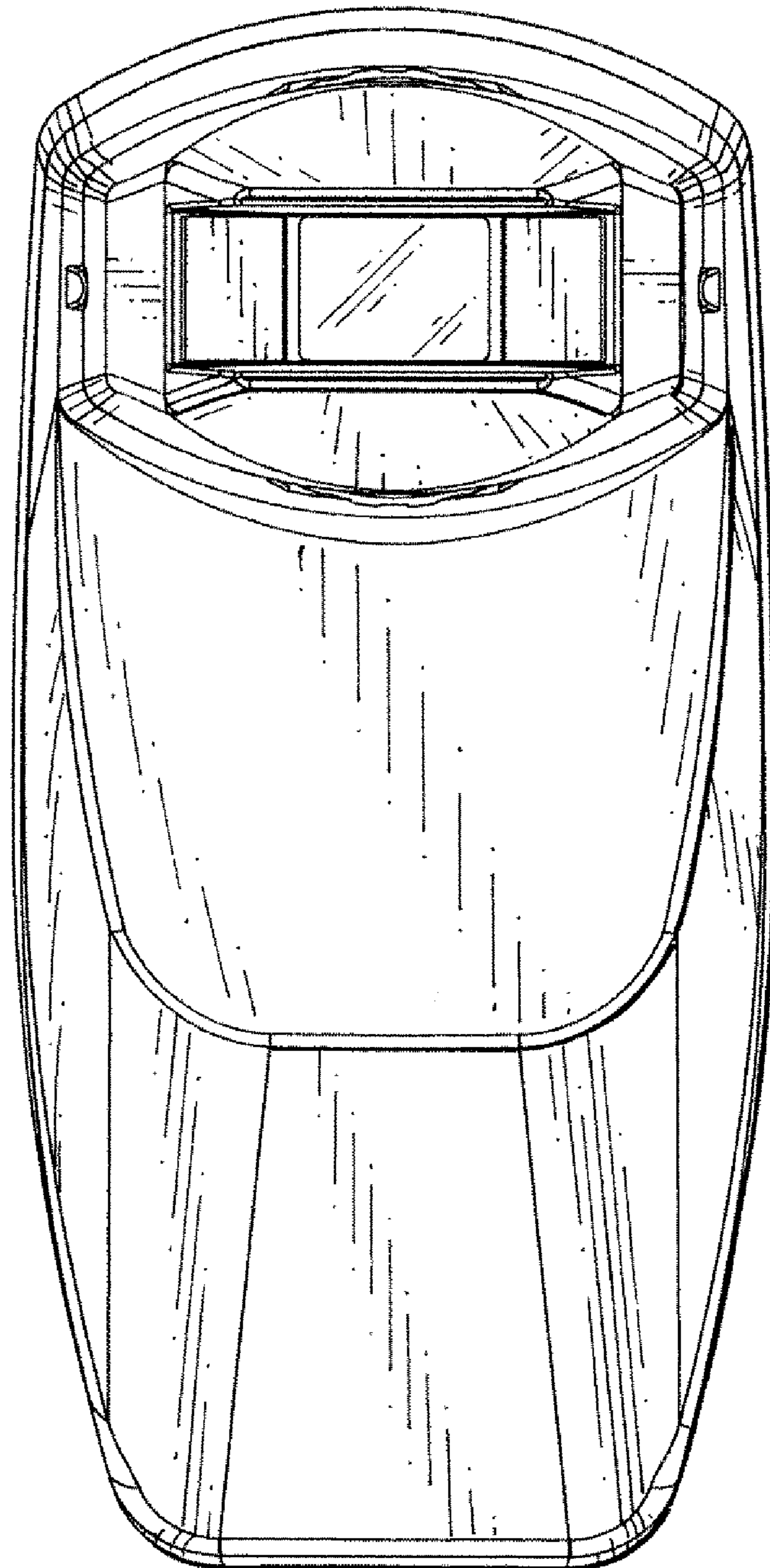

FIG. 3

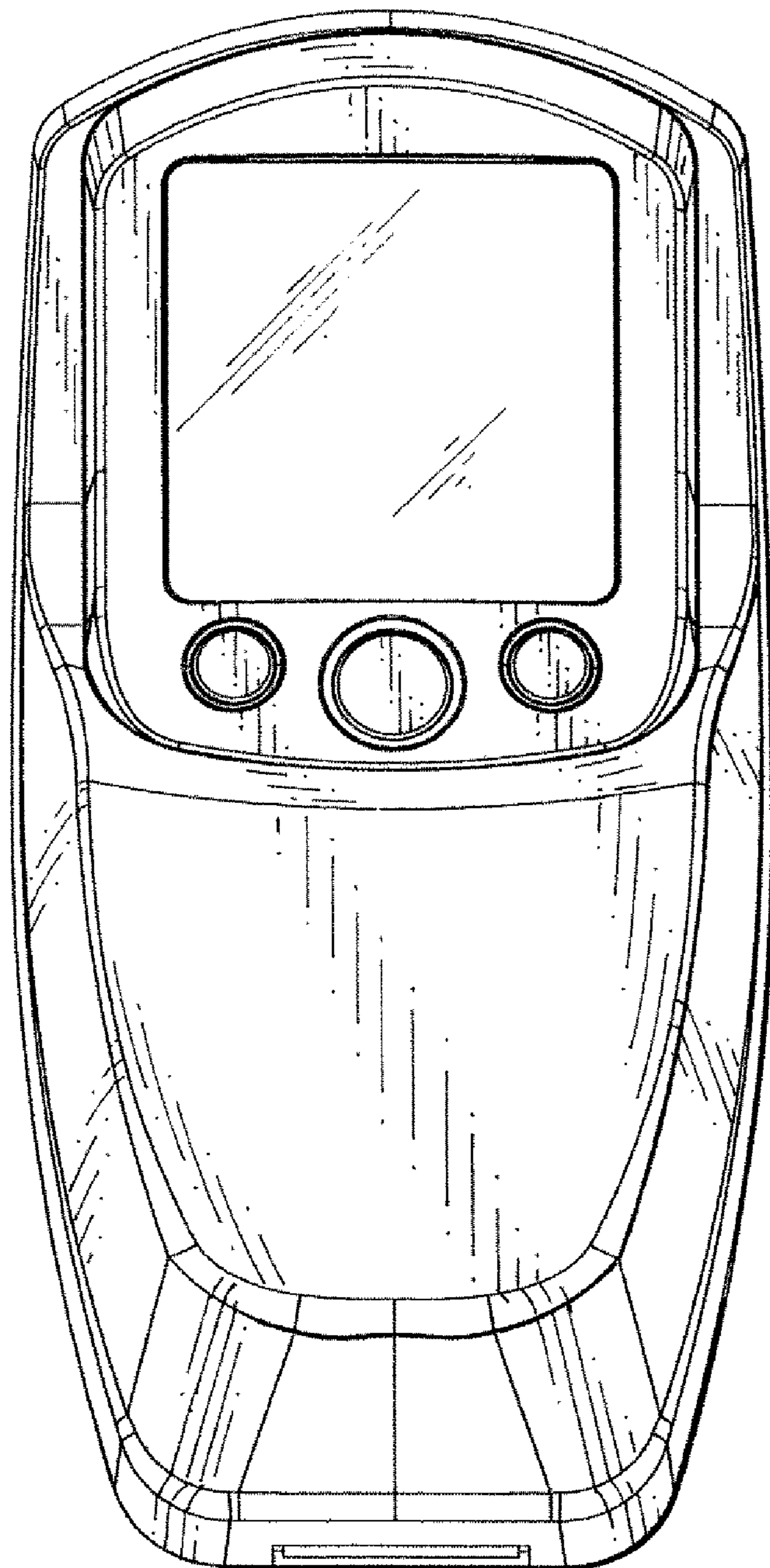

FIG. 4

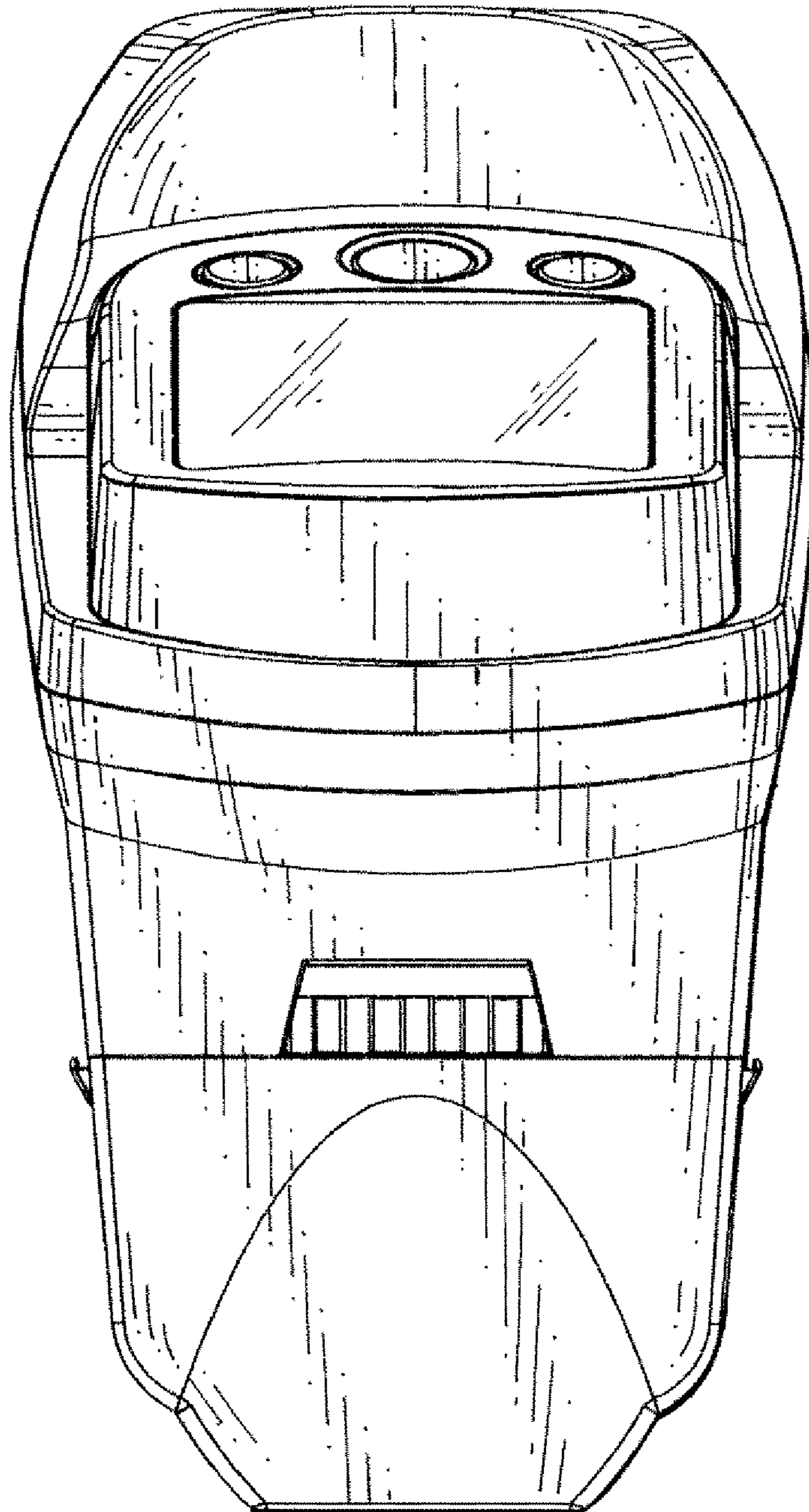

FIG. 5

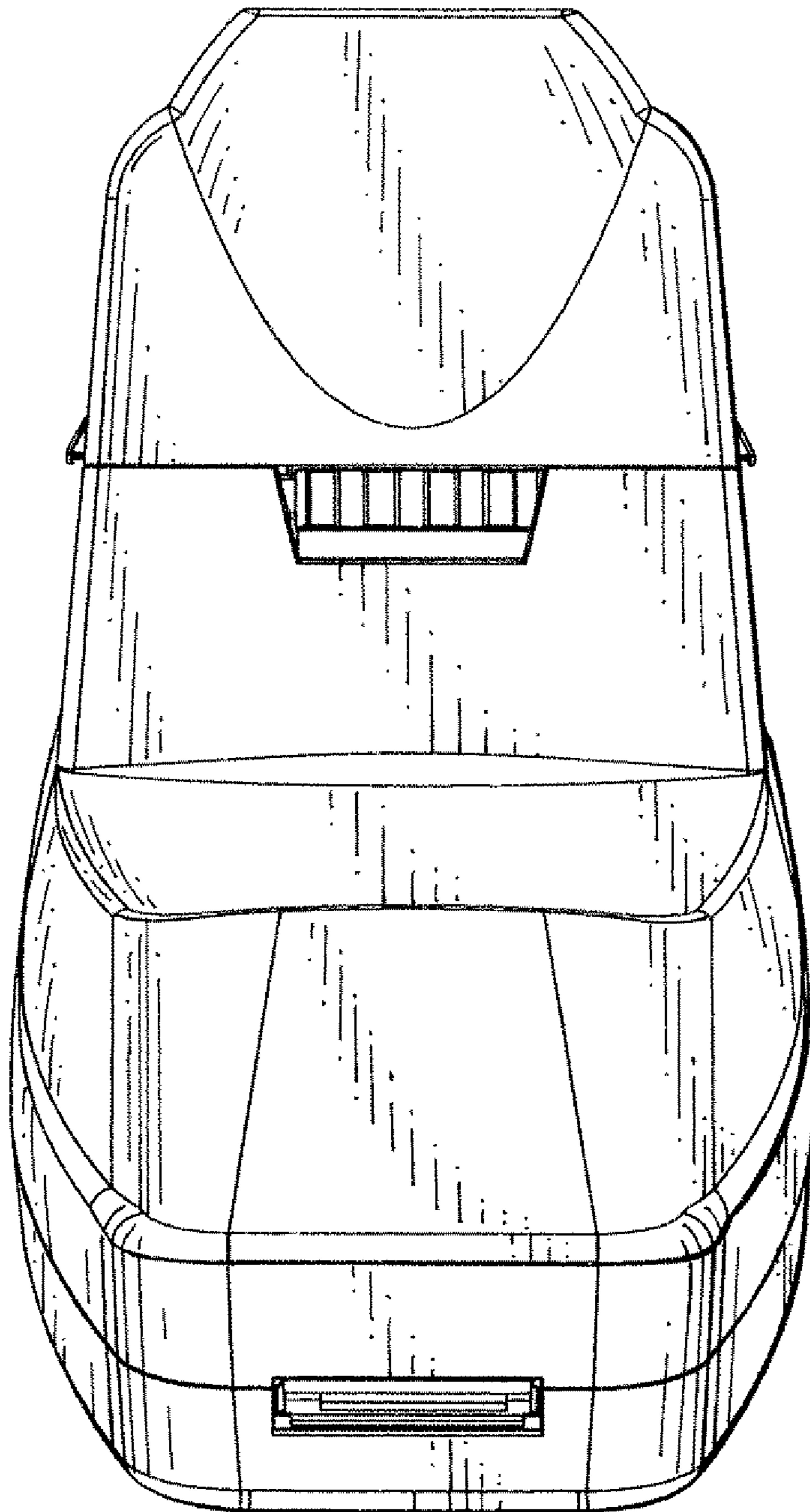

FIG. 6

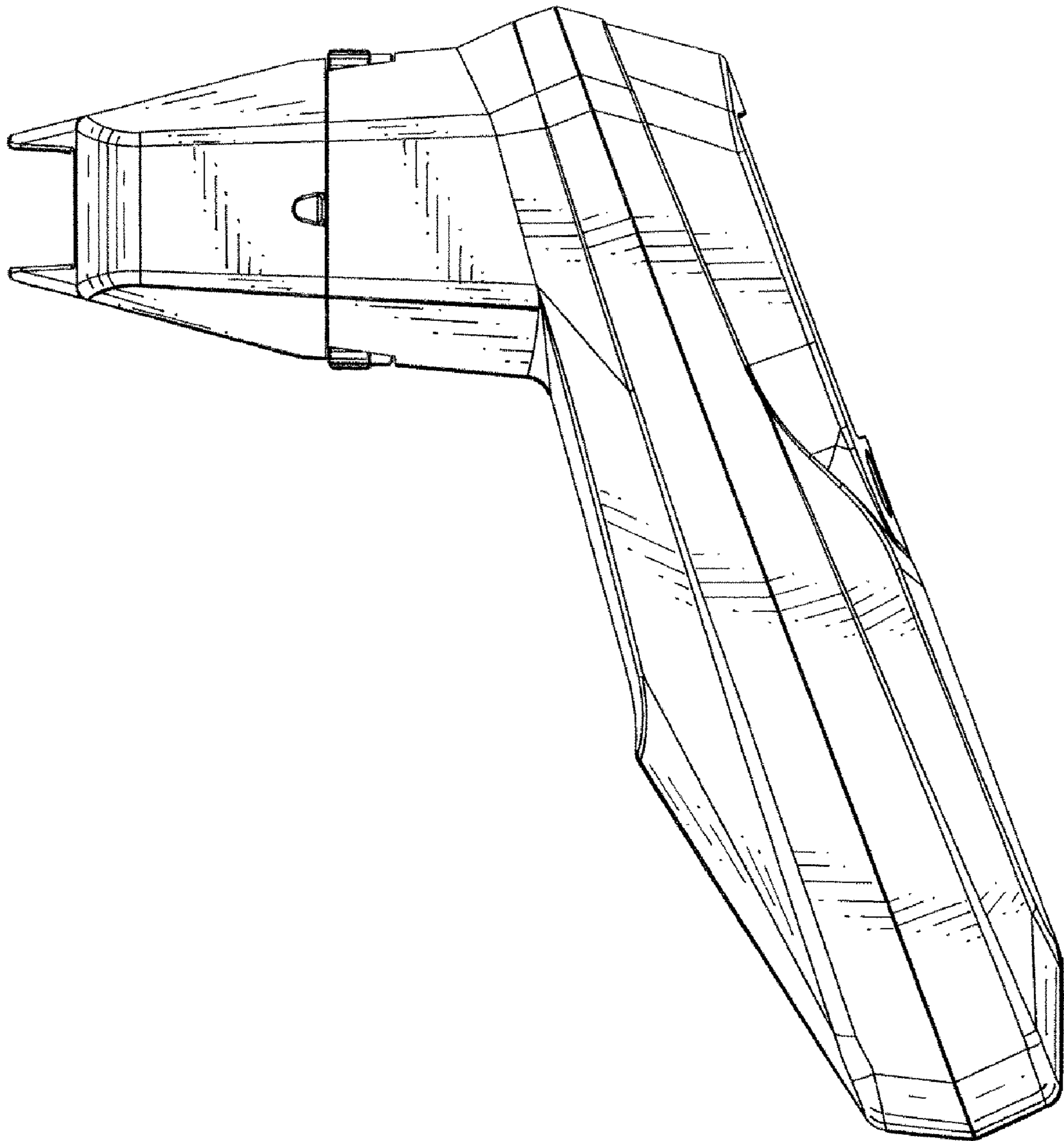

FIG. 7

