



US00D585540S

(12) **United States Design Patent**
Lithgow et al.

(10) **Patent No.:** **US D585,540 S**
(45) **Date of Patent:** **** Jan. 27, 2009**

(54) **AIR DELIVERY DEVICE**

(75) Inventors: **Perry David Lithgow**, Glenwood (AU);
Duncan Lovel Trevor-Wilson, Frenchs
Forest (AU); **Arthur Kin-Wai Yee**,
Pymble (AU); **Rohan Neil Primrose**,
Marsfield (AU); **Alexander Virr**,
Balmain (AU); **Mark Bertinetti**, Lane
Cove (AU); **Dan Kao**, Chatswood (AU);
Michael Thomas Janiak, North Epping
(AU)

(73) Assignee: **ResMed Limited**, Bella Vista (AU)

(**) Term: **14 Years**

(21) Appl. No.: **29/274,262**

(22) Filed: **Apr. 10, 2007**

Related U.S. Application Data

(62) Division of application No. 29/207,856, filed on Jun.
18, 2004, now Pat. No. Des. 544,598.

(51) **LOC (9) Cl.** **29-02**

(52) **U.S. Cl.** **D24/110**

(58) **Field of Classification Search** D24/110,
D24/164; D23/356, 358; 128/200.24, 200.23,
128/200.18, 200.22, 200.16, 204.14, 203.16,
128/203.17, 204.18, 204.23

See application file for complete search history.

(56) **References Cited**

U.S. PATENT DOCUMENTS

D421,298 S 2/2000 Kenyon et al.

D427,675 S 7/2000 Hansel
D467,335 S 12/2002 Lithgow et al.
D476,077 S 6/2003 Lithgow et al.
D487,311 S 3/2004 Lithgow et al.
D493,520 S 7/2004 Bertinetti et al.
D493,884 S 8/2004 Virr et al.
D498,527 S 11/2004 Virr et al.
D503,796 S 4/2005 Lithgow et al.

OTHER PUBLICATIONS

U.S. Appl. No. 29/207,856, filed Jun. 18, 2004, Lithgow et al.

Primary Examiner—Ian Simmons

Assistant Examiner—Christopher Lee

(74) *Attorney, Agent, or Firm*—Nixon & Vanderhye P.C.

(57) **CLAIM**

The ornamental design for an air delivery device, as shown
and described.

DESCRIPTION

FIG. 1 is a perspective view of an air delivery device accord-
ing to an embodiment of our design;

FIG. 2 is a top view thereof;

FIG. 3 is a front view thereof;

FIG. 4 is a rear view thereof;

FIG. 5 is a left side view thereof; and,

FIG. 6 is a right side view thereof.

Where included, broken lines showing environment or struc-
ture are for illustrative purposes only and form no part of the
claimed design.

1 Claim, 6 Drawing Sheets

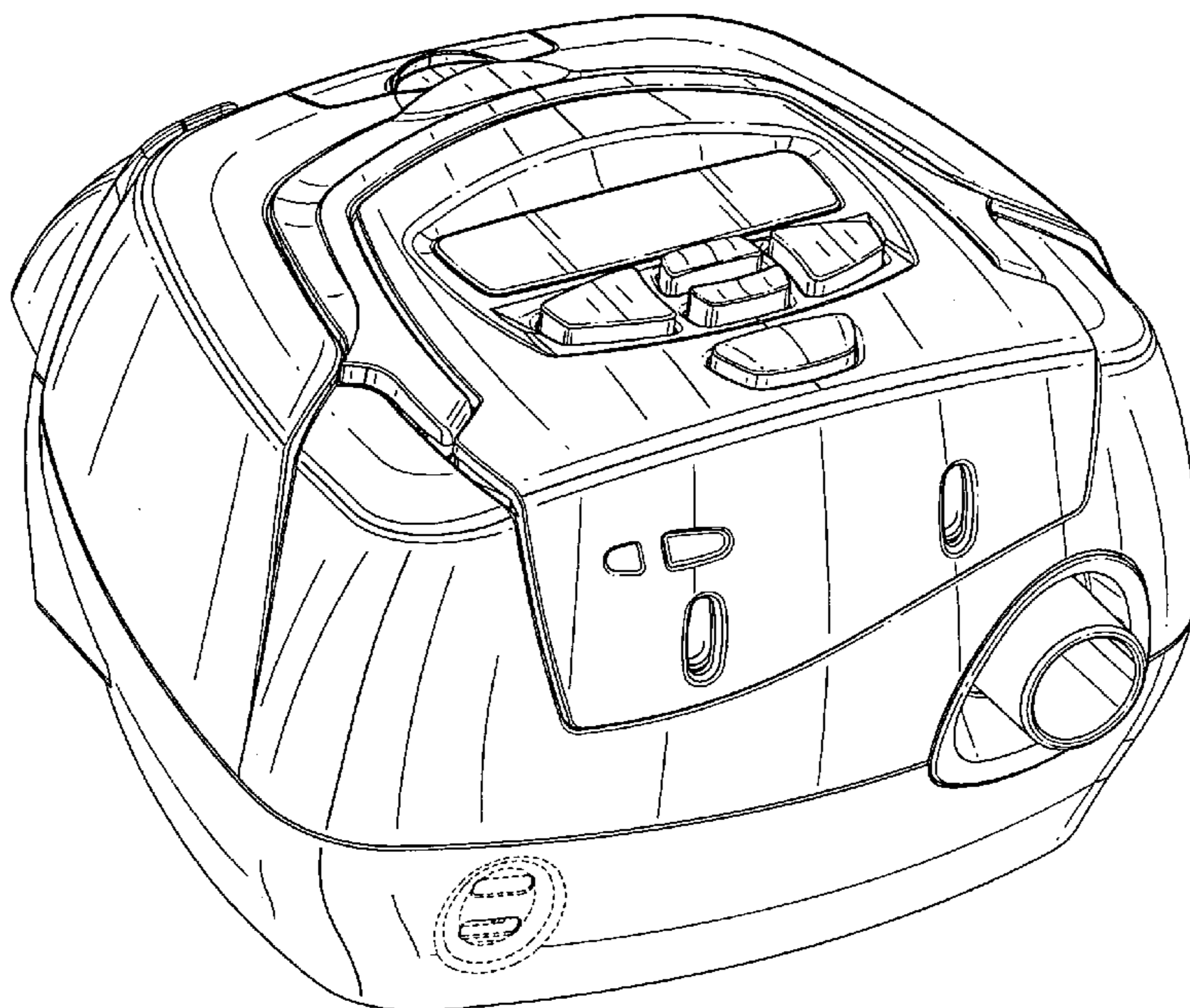

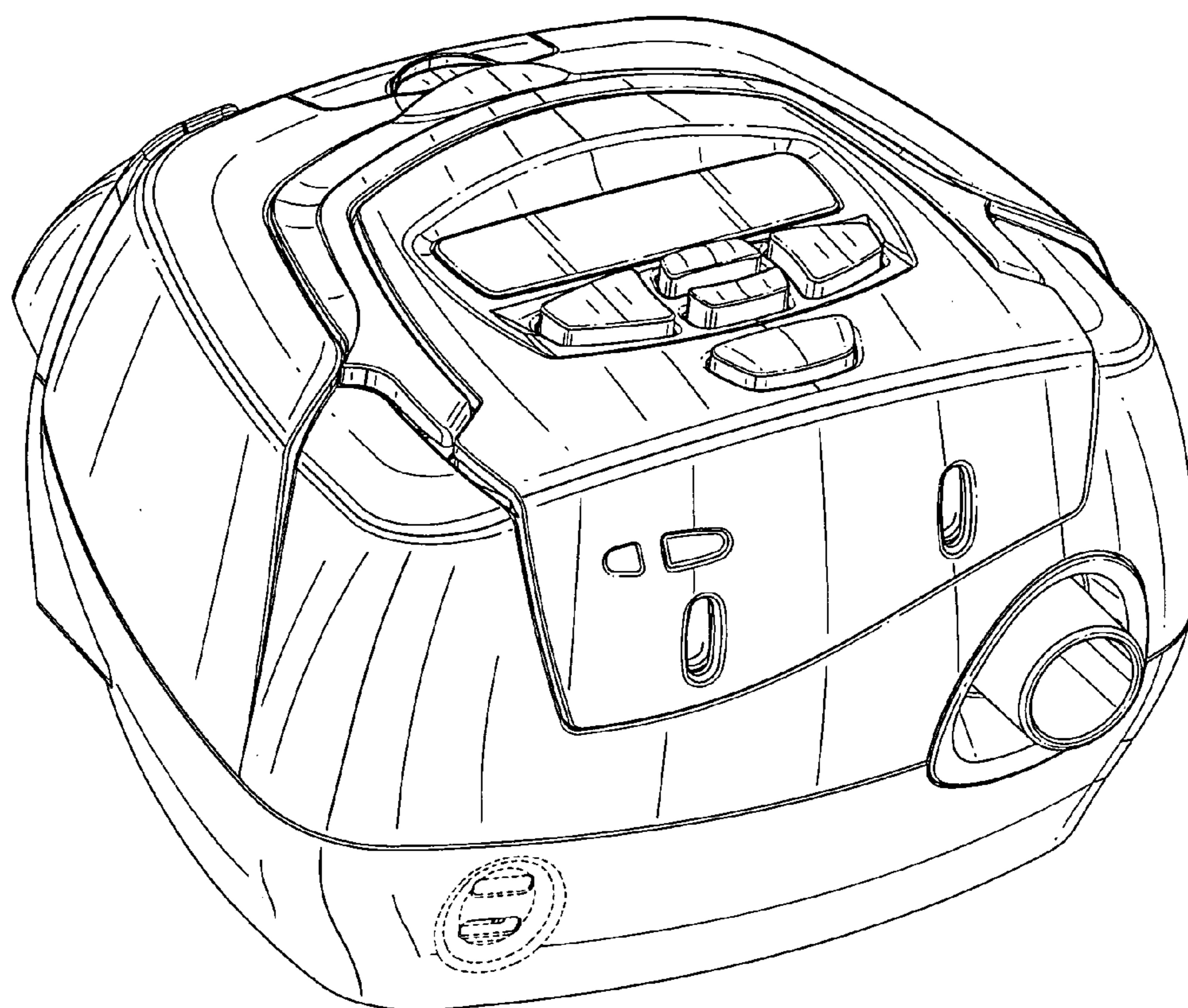

Fig. 1

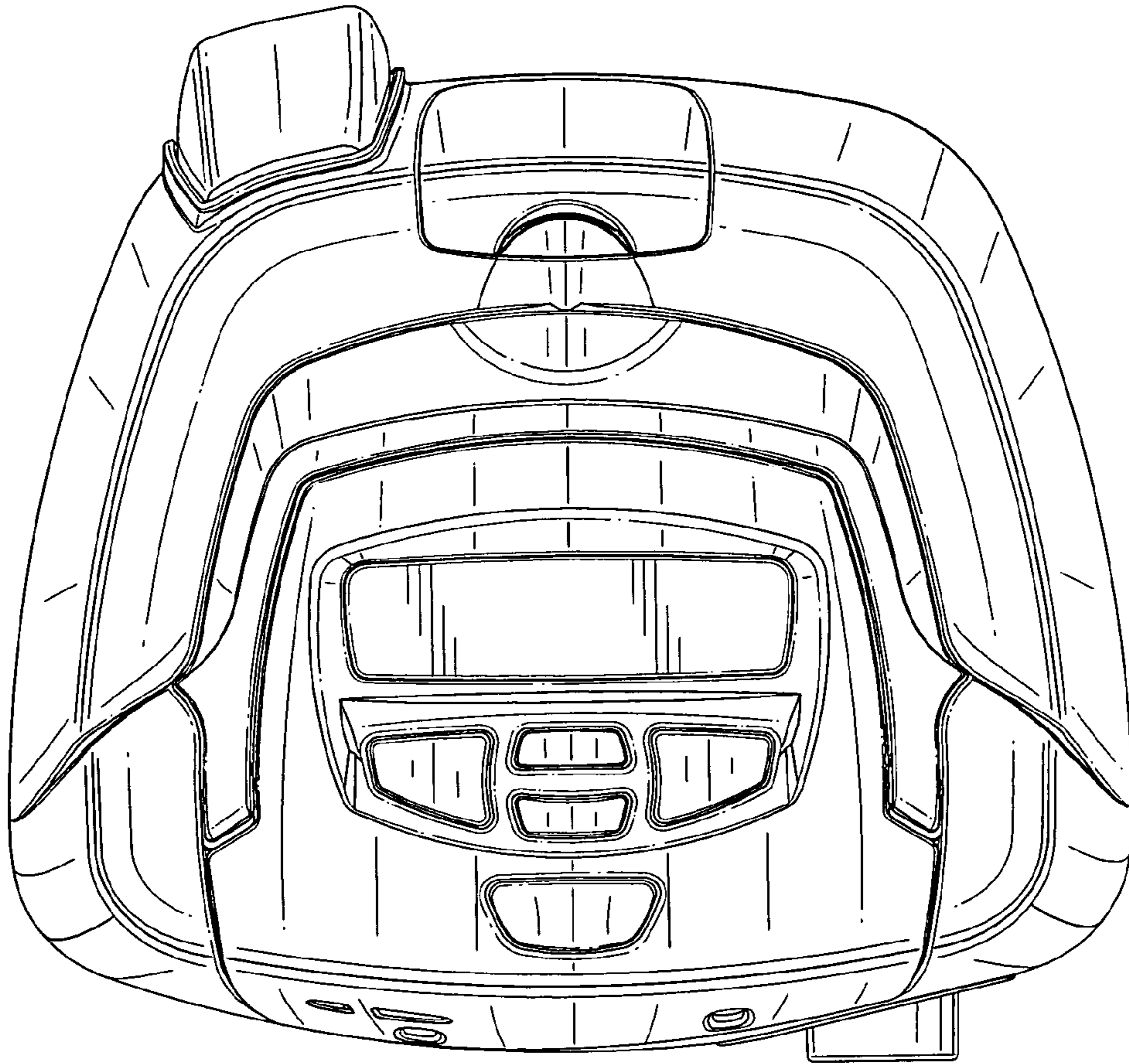

Fig. 2

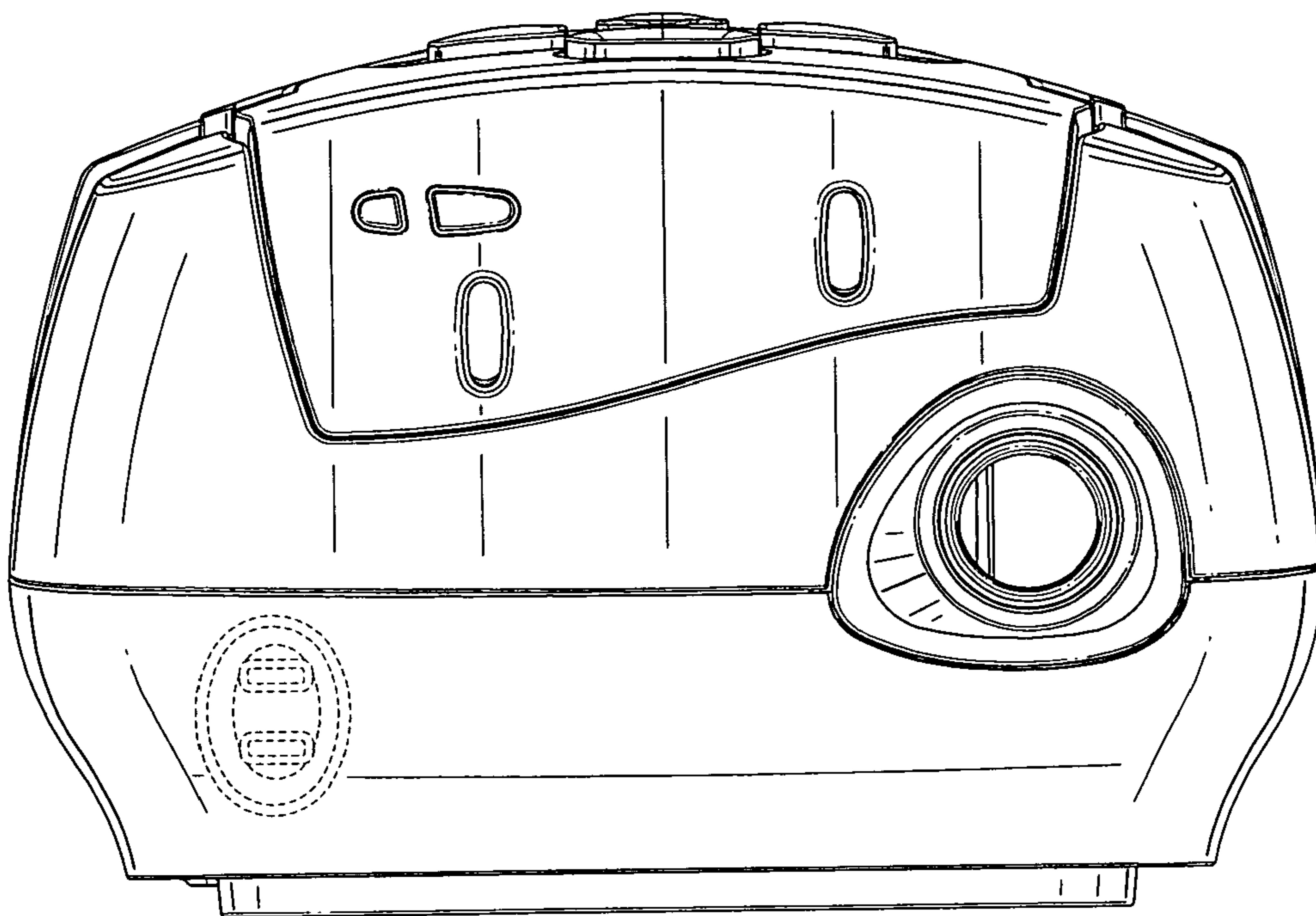

Fig. 3

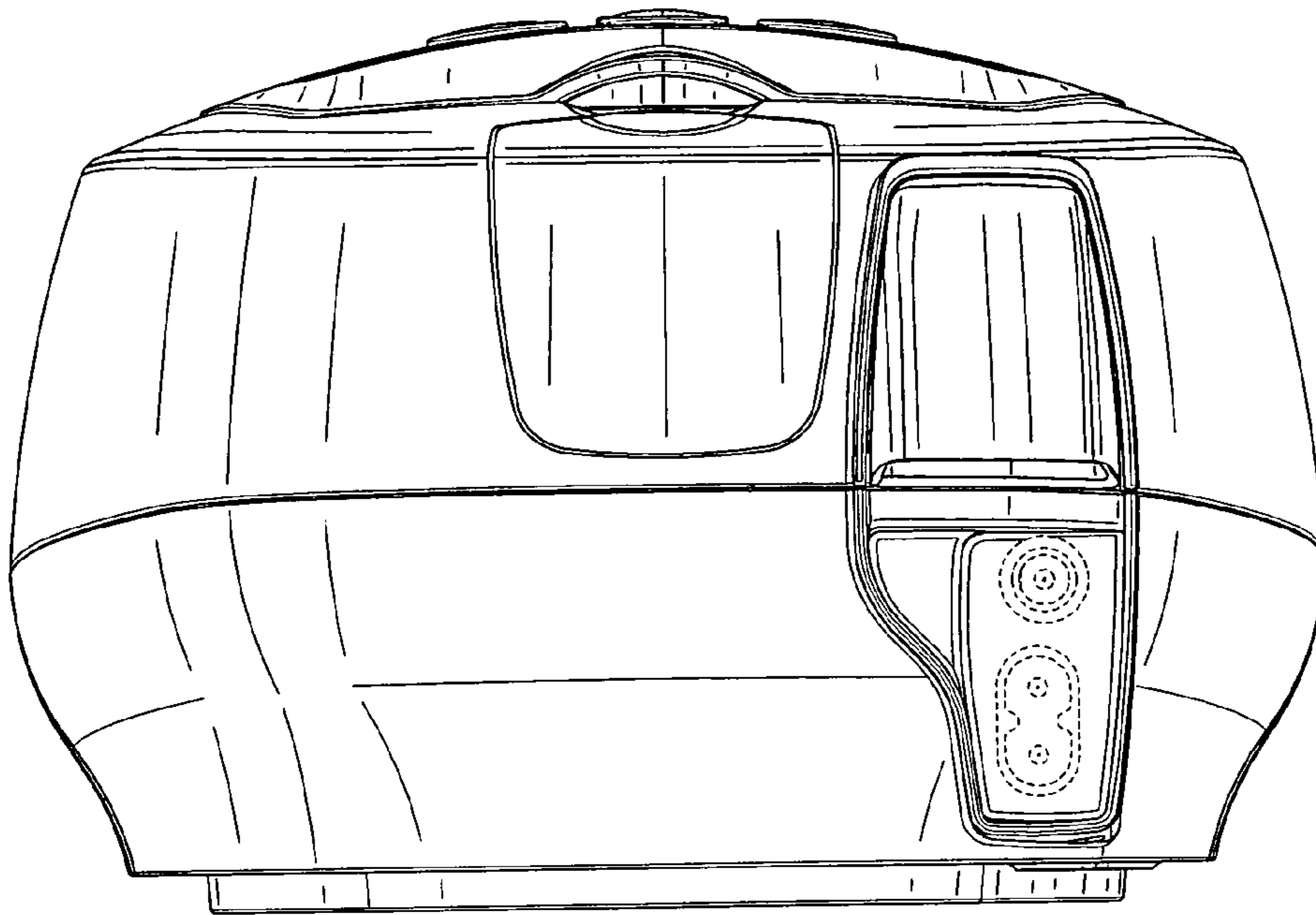

Fig. 4

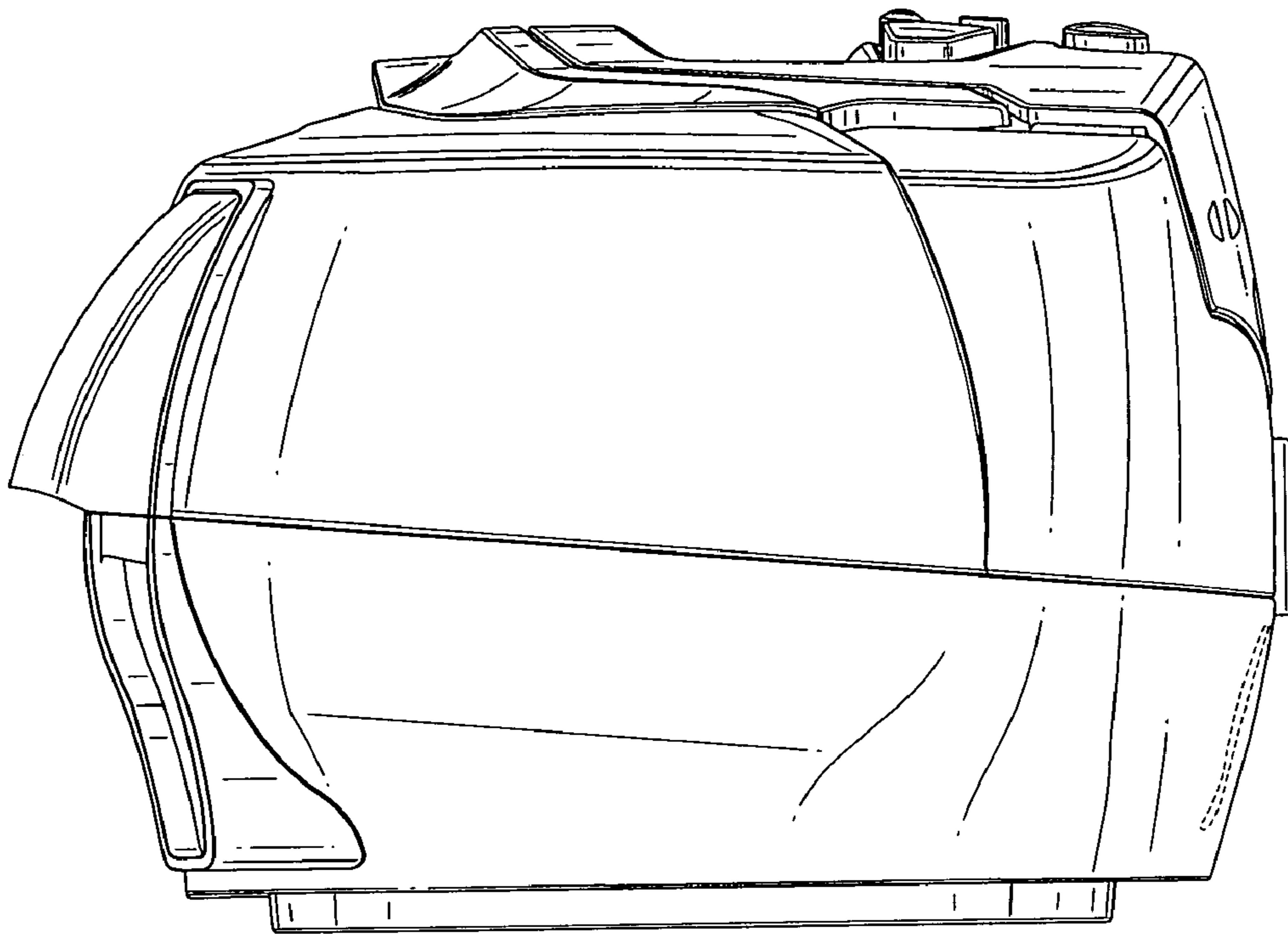

Fig. 5

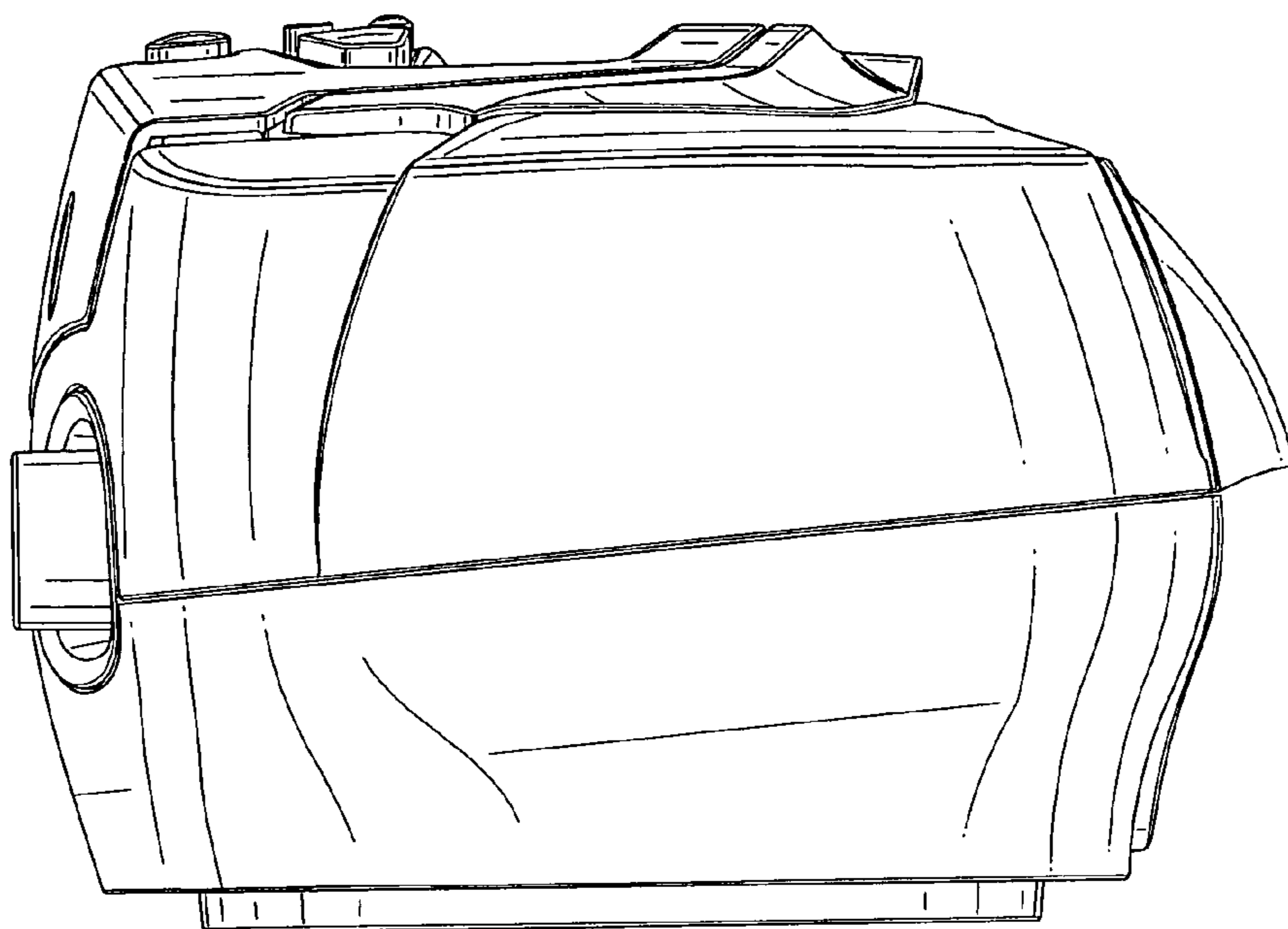

Fig. 6

UNITED STATES PATENT AND TRADEMARK OFFICE
Certificate

Patent No. D. 585,540 S

Patented: January 27, 2009

On petition requesting issuance of a certificate for correction of inventorship pursuant to 35 U.S.C. 256, it has been found that the above identified patent, through error and without any deceptive intent, improperly sets forth the inventorship.

Accordingly, it is hereby certified that the correct inventorship of this patent is: Perry David Lithgow, Glenwood (AU); Duncan Lovel Trevor-Wilson, Frenchs Forest (AU); Arthur Kin-Wai Yee, Pymble (AU); Rohan Neil Primrose, Marsfield (AU); Alexander Virr, Balmain (AU); Dan Kao, Chatswood (AU); and Michael Thomas Janiak, North Epping (AU).

Signed and Sealed this Sixth Day of September 2011.

IAN SIMMONS
Supervisory Patent Examiner
Art Unit 2916
Technology Center 2900