



US00D585450S

(12) **United States Design Patent**  
**DeMaio et al.**

(10) **Patent No.:** **US D585,450 S**  
(45) **Date of Patent:** **\*\* Jan. 27, 2009**

(54) **KEY FOR AN INPUT DEVICE**

2002/0109675 A1 8/2002 Kuan  
2004/0009790 A1 1/2004 Im

(75) Inventors: **Pasquale DeMaio**, Bellevue, WA (US);  
**Isabelo V. de los Reyes**, Bellevue, WA  
(US); **Steven T. Kaneko**, Medina, WA  
(US); **Carl J. Ledbetter**, Mercer Island,  
WA (US); **Greg G. Jones**, Seattle, WA  
(US); **Tucker Fort**, New York, NY (US);  
**Tim Kennedy**, Staten Island, NY (US);  
**Courtney Smith**, West Orange, NJ (US)

\* cited by examiner

*Primary Examiner*—Freda S Nunn  
(74) *Attorney, Agent, or Firm*—Banner & Witcoff, Ltd.

(73) Assignee: **Microsoft Corporation**, Redmond, WA  
(US)

(57) **CLAIM**

The ornamental design for a key for an input device, as shown  
and described.

(\*\*) Term: **14 Years**

**DESCRIPTION**

(21) Appl. No.: **29/319,084**

FIG. 1 is a perspective view of a key showing our design;

(22) Filed: **Jun. 3, 2008**

FIG. 2 is a top view of the key of FIG. 1;

**Related U.S. Application Data**

(62) Division of application No. 29/237,765, filed on Sep.  
7, 2005, now Pat. No. Des. 570,357.

FIG. 3 is a front view of the key of FIG. 1;

(51) **LOC (9) Cl.** ..... **14-02**

(52) **U.S. Cl.** ..... **D14/456**

(58) **Field of Classification Search** ..... D14/391-399,  
D14/455, 456, 385; D18/1, 2, 7, 11; 200/5 A,  
200/5 R, 6 A, 6 R, 341; 235/380, 382, 382.5;  
341/22, 23; 345/160, 168, 173; 400/477,  
400/484-486, 492, 692; 455/556.1

FIG. 4 is a right side view of the key of FIG. 1, the left side  
view being a mirror image thereof;

FIG. 5 is a perspective view of another key showing our  
design;

FIG. 6 is a sectional view of the key of FIG. 5 taken through  
line 6-6 of FIG. 5

FIG. 7 is a side view of the key of FIG. 5 showing a disclaimed  
key supporting element;

FIG. 8 is a perspective view of another key showing our  
design;

FIG. 9 is a top view of the key of FIG. 8;

FIG. 10 is a front view of the key of FIG. 8;

FIG. 11 is a right side view of the key of FIG. 8, the left side  
view being a mirror image thereof;

FIG. 12 is a sectional view of the key of FIG. 8 taken through  
line 12-12 of FIG. 9

FIG. 13 is a side view of the key of FIG. 8 showing a dis-  
claimed key supporting element;

FIG. 14 is a top view of another key showing our design;

FIG. 15 is a front view of the key of FIG. 14;

FIG. 16 is a right side view of the key of FIG. 14;

FIG. 17 is a top view of another key showing our design;

FIG. 18 is a front view of the key of FIG. 17;

(56) **References Cited**

**U.S. PATENT DOCUMENTS**

5,387,042 A	2/1995	Brown	
D358,382 S	5/1995	Franz	
5,763,842 A	6/1998	Tsai et al.	
5,836,705 A	11/1998	Choate	
6,259,049 B1	7/2001	Nakai	
D467,932 S	12/2002	Jones	
D481,730 S	11/2003	Kang et al.	
6,686,549 B2	2/2004	Douzono et al.	
D570,357 S *	6/2008	DeMaio et al.	..... D14/456

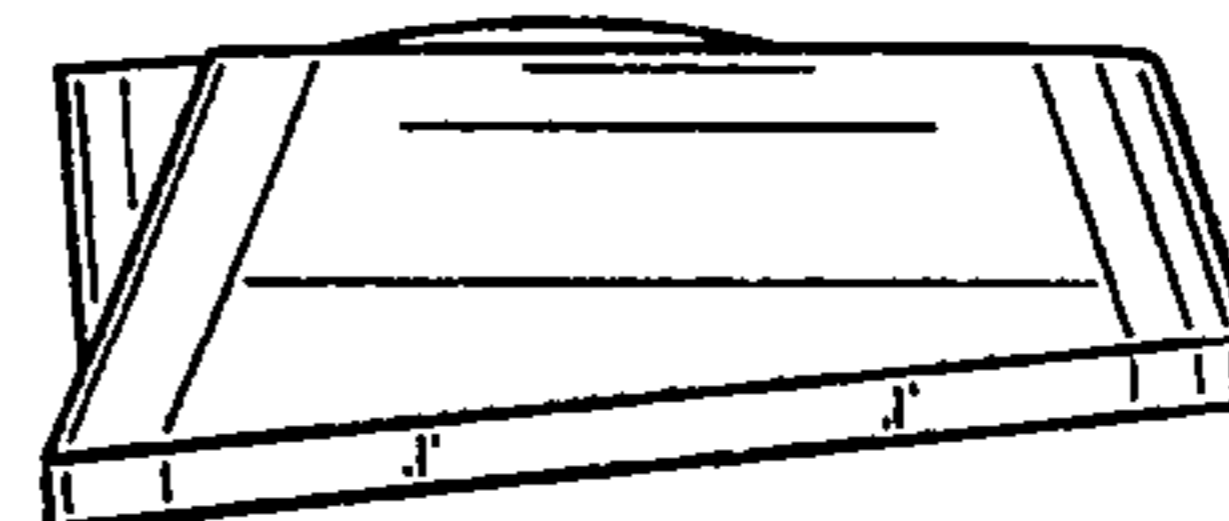
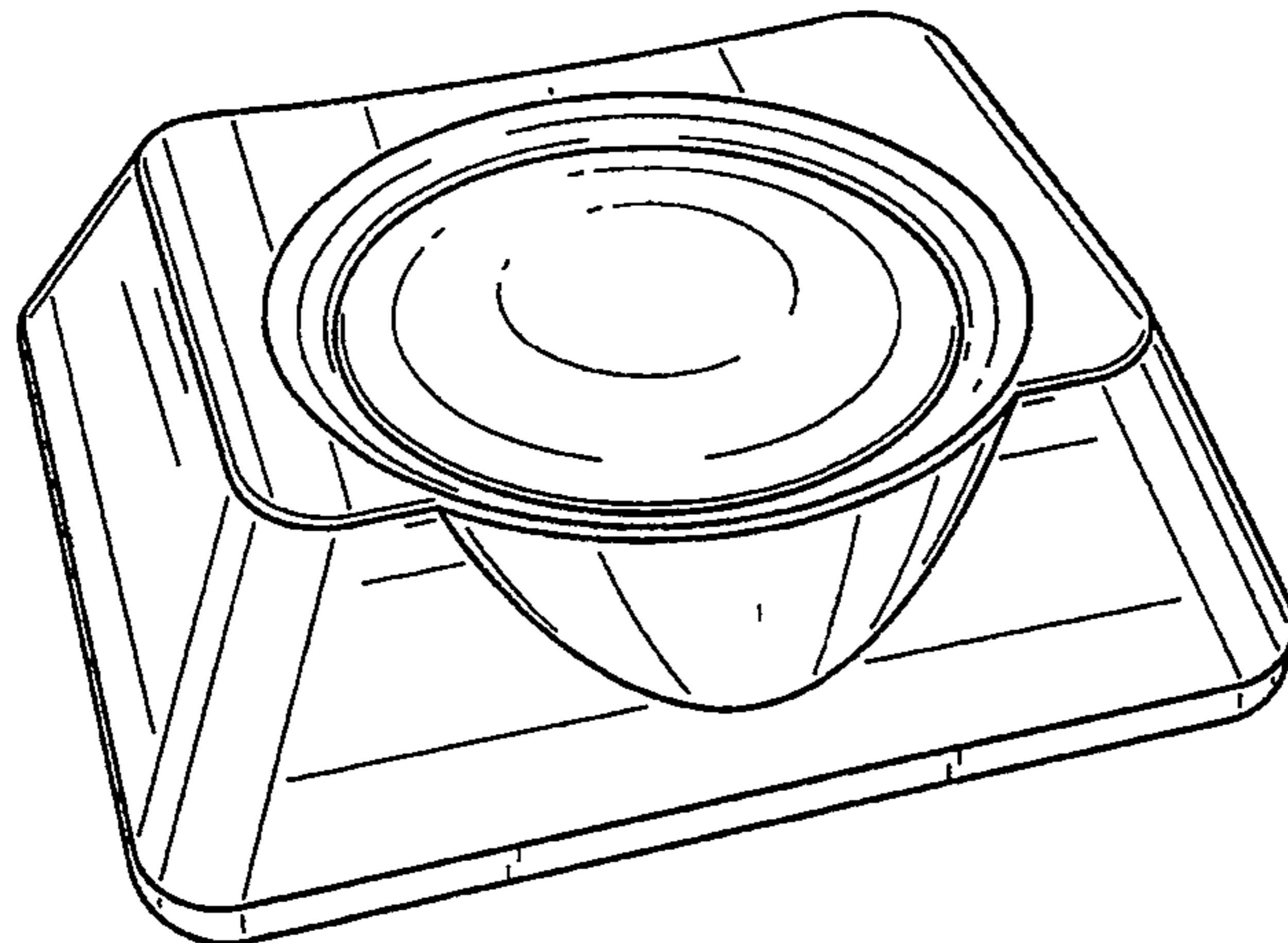

FIG. 19 is a right side view of the key of FIG. 17;  
FIG. 20 is a top view of another key showing our design;  
FIG. 21 is a front view of the key of FIG. 20;  
FIG. 22 is a right side view of the key of FIG. 20;  
FIG. 23 is a top view of another key showing our design;  
FIG. 24 is a front view of the key of FIG. 23;  
FIG. 25 is a right side view of the key of FIG. 23;  
FIG. 26 is a top view of another key showing our design;  
FIG. 27 is a right side view of the key of FIG. 26; the left side view being a mirror image thereof;  
FIG. 28 is a front view of the key of FIG. 26;  
FIG. 29 is a top view of another key showing our design;  
FIG. 30 is a front view of the key of FIG. 29;  
FIG. 31 is a right side view of the key of FIG. 29; the left side view being a mirror image thereof;

FIG. 32 is a top view of another key showing our design;  
FIG. 33 is a front view of the key of FIG. 32;  
FIG. 34 is a right side view of the key of FIG. 32; the left side view being a mirror image thereof;  
FIG. 35 is a top view of another key showing our design;  
FIG. 36 is a front view of the key of FIG. 35;  
FIG. 37 is a right side view of the key of FIG. 35; the left side view being a mirror image thereof; and,  
FIG. 38 is a partial view of the central circular convex element and surrounding rim of the keys shown in all of the previous figures.

The broken line showings represent environmental structure only and form no part of the claimed design.

**1 Claim, 10 Drawing Sheets**

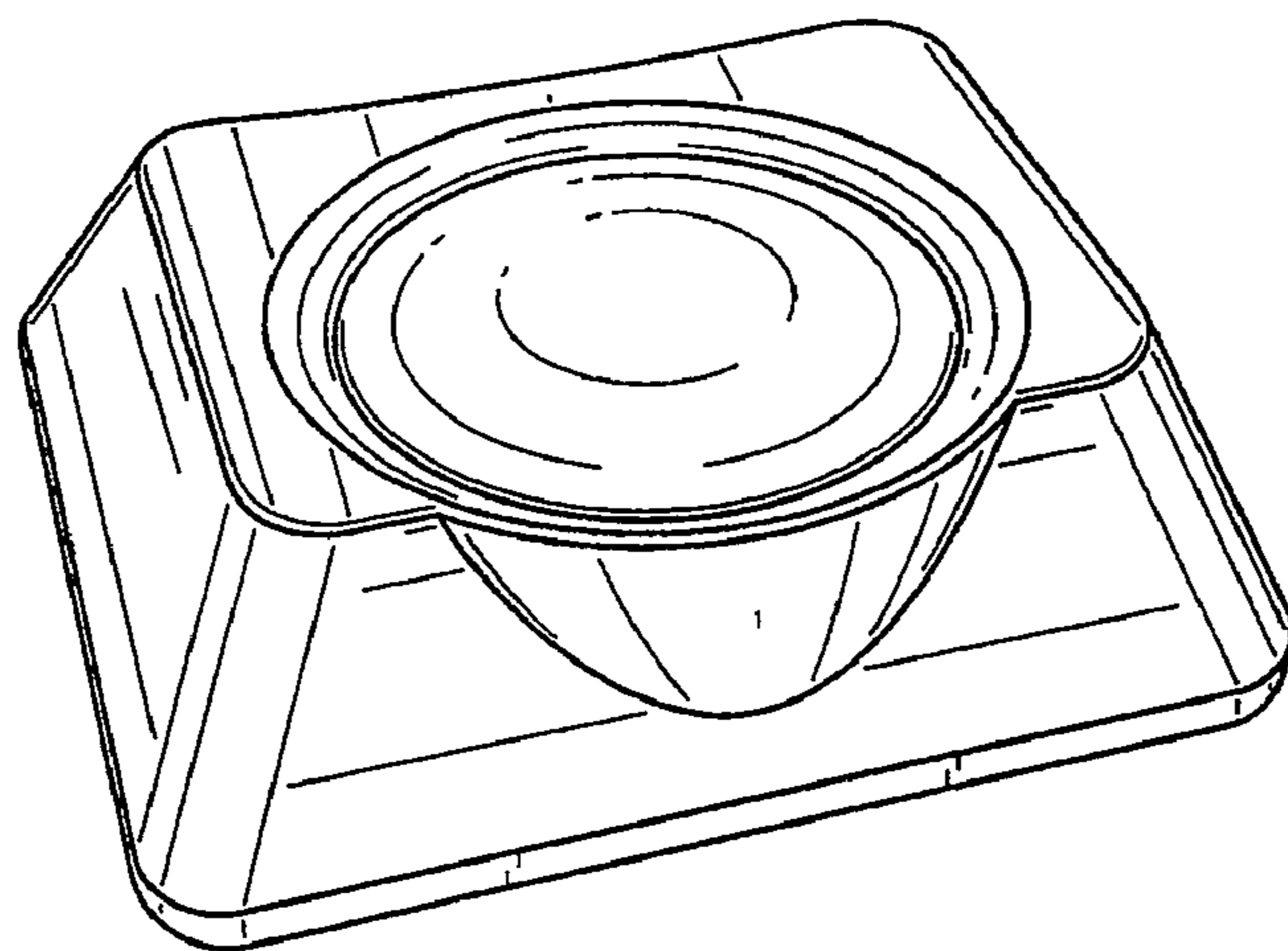

FIG. 1

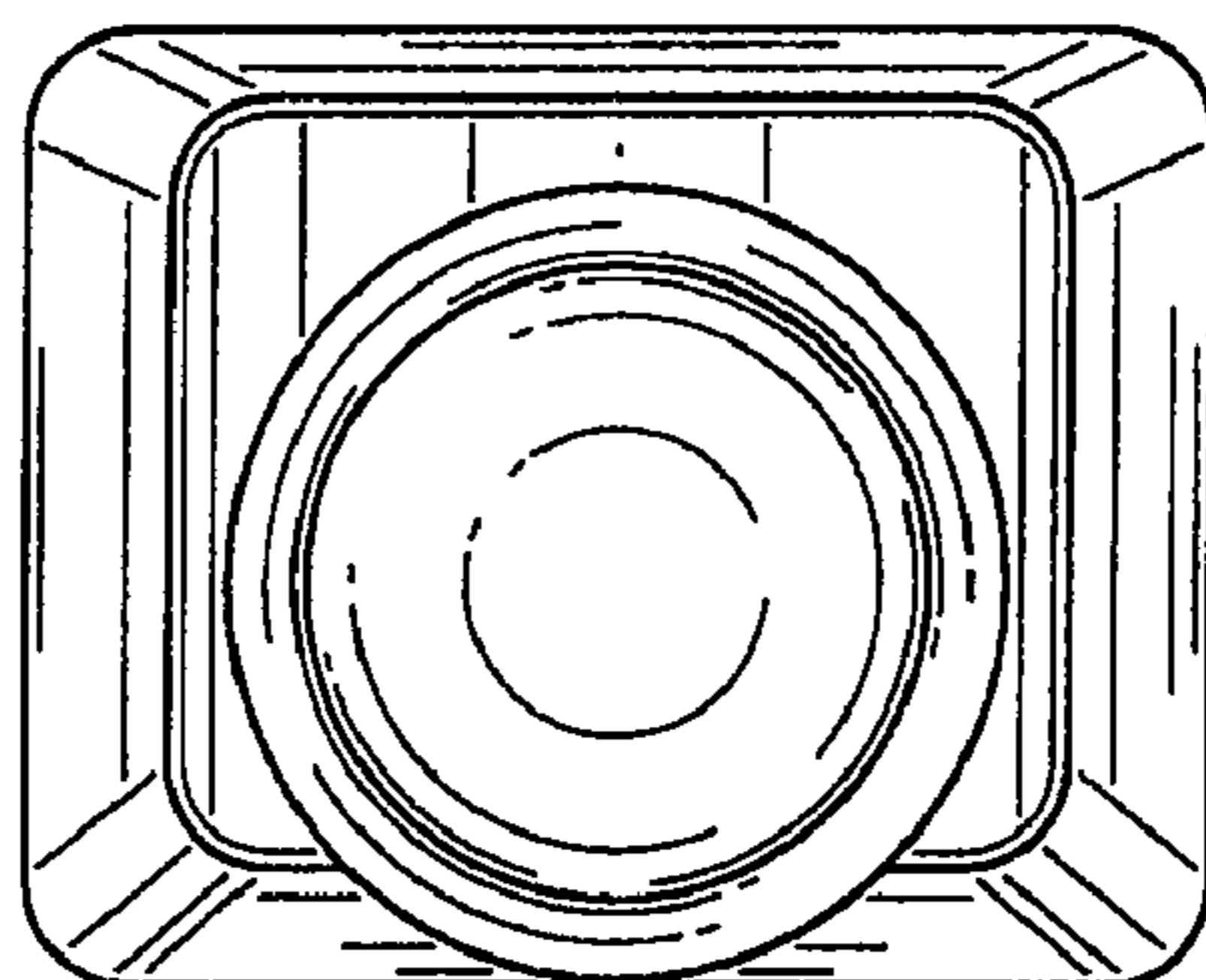

FIG. 2

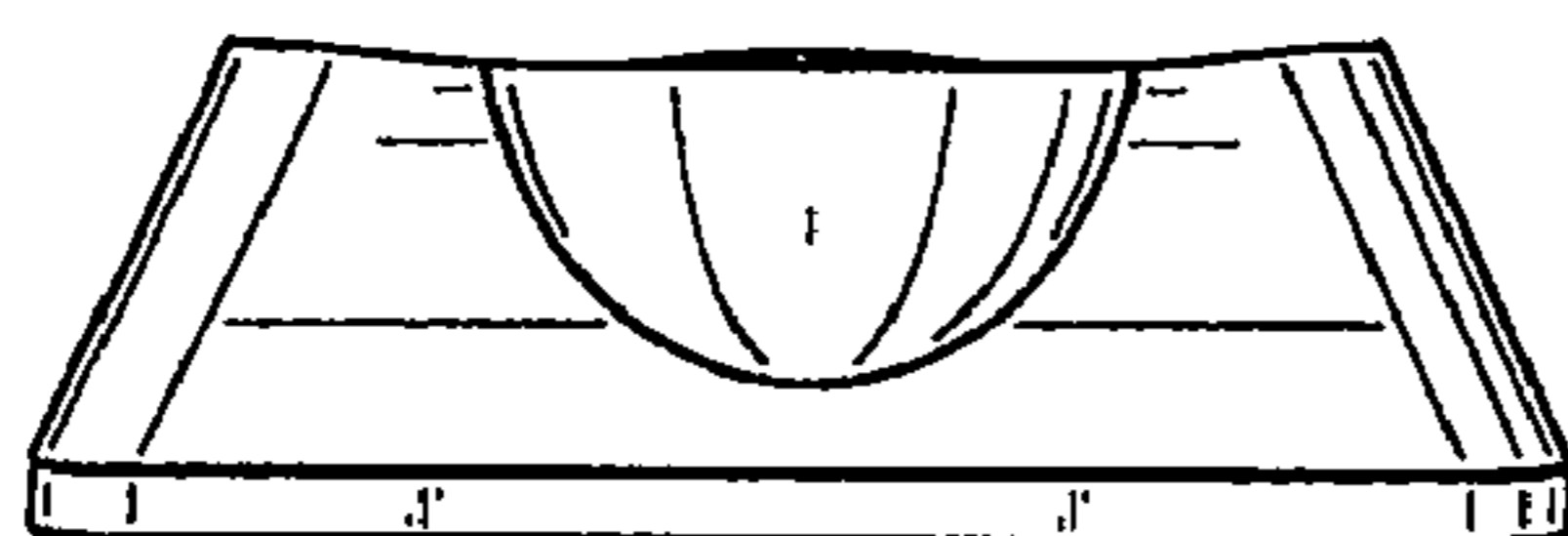

FIG. 3

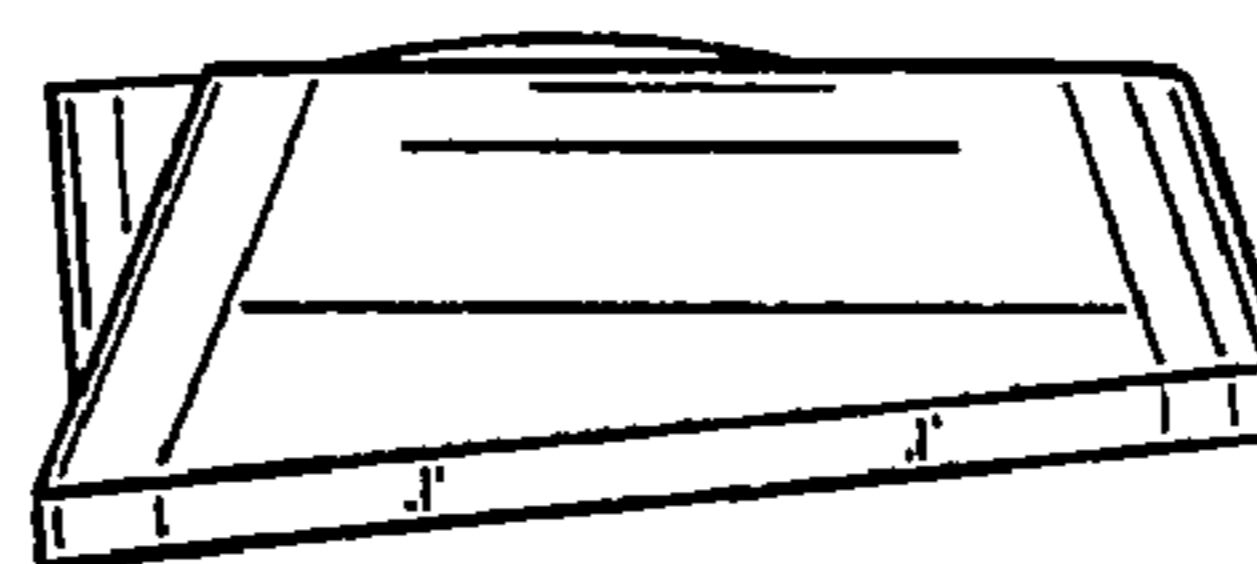

FIG. 4

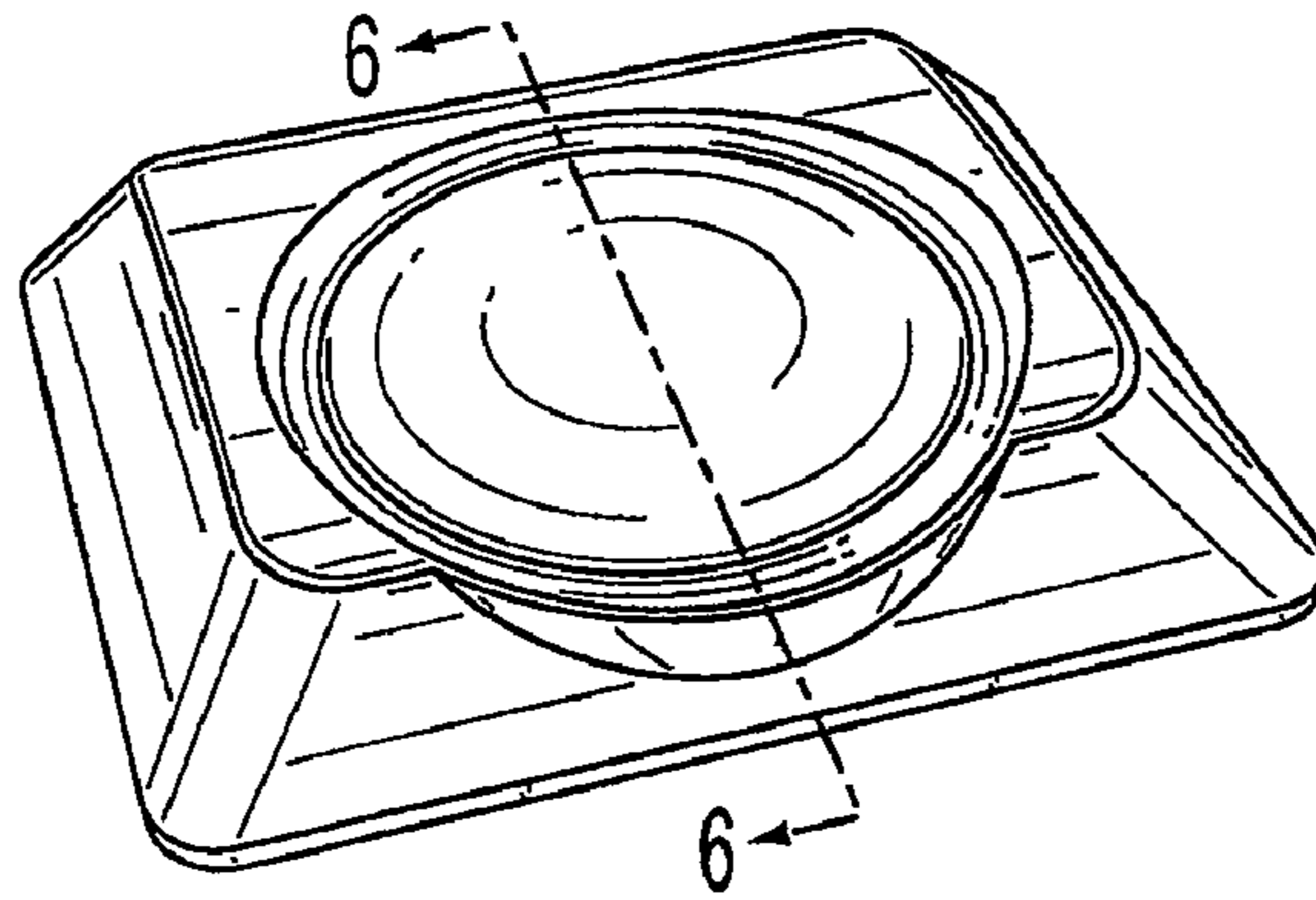

FIG. 5

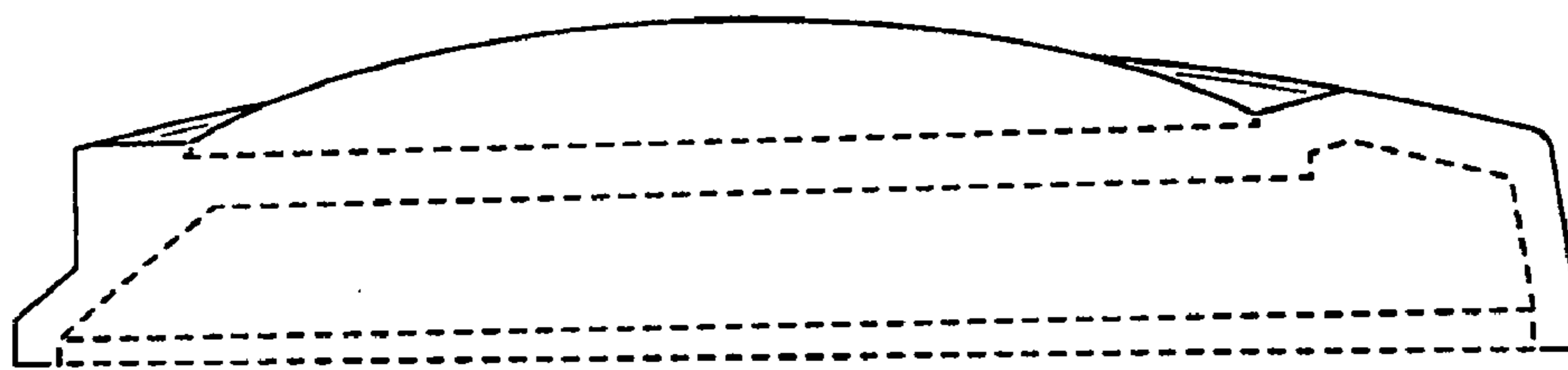

FIG. 6

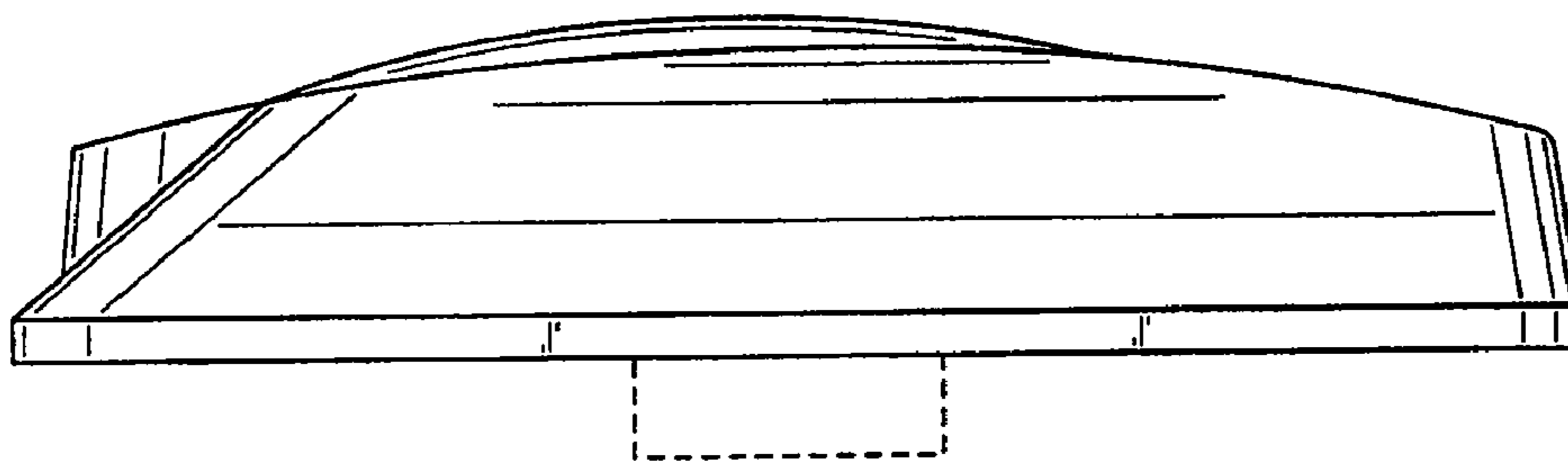

FIG. 7



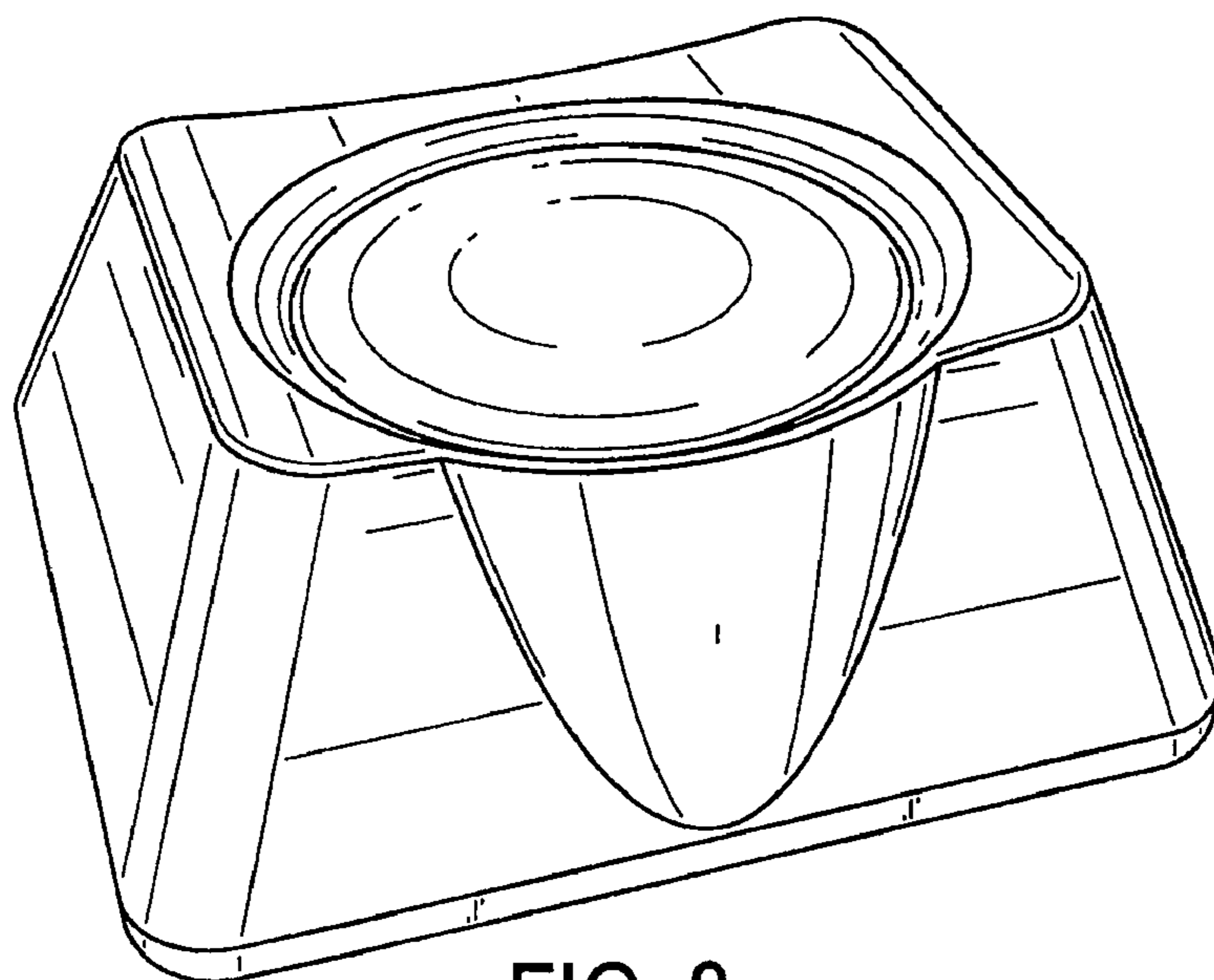

FIG. 8

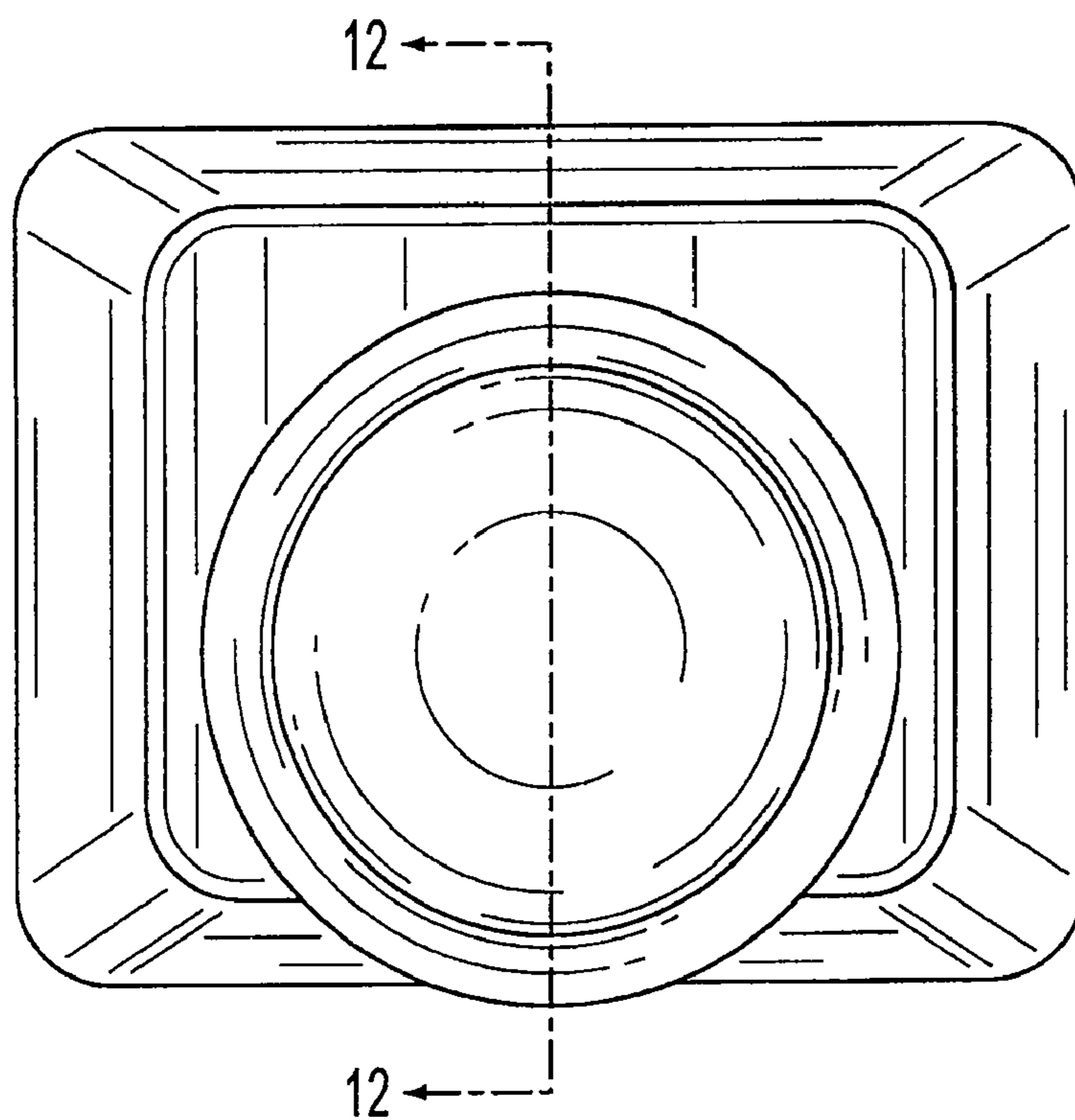

FIG. 9

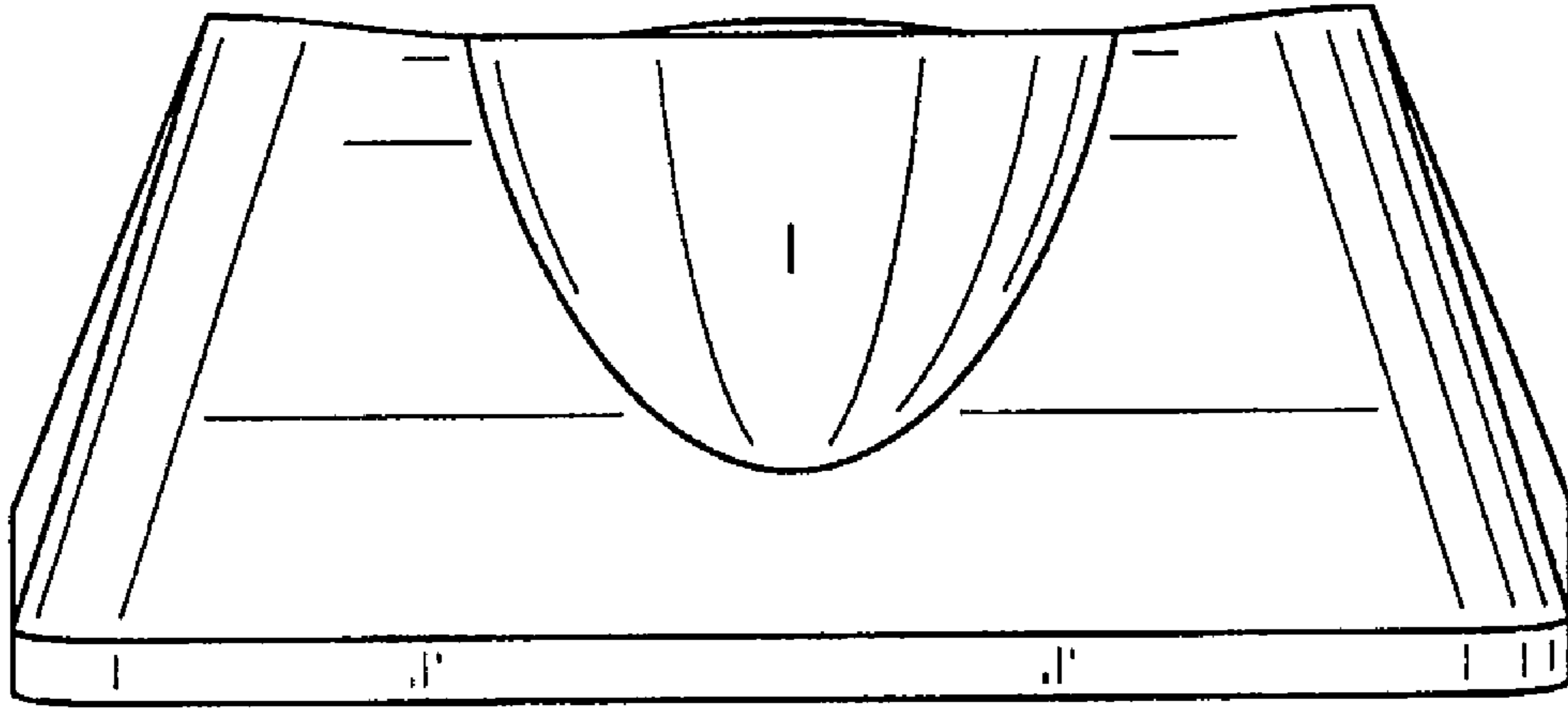

FIG. 10

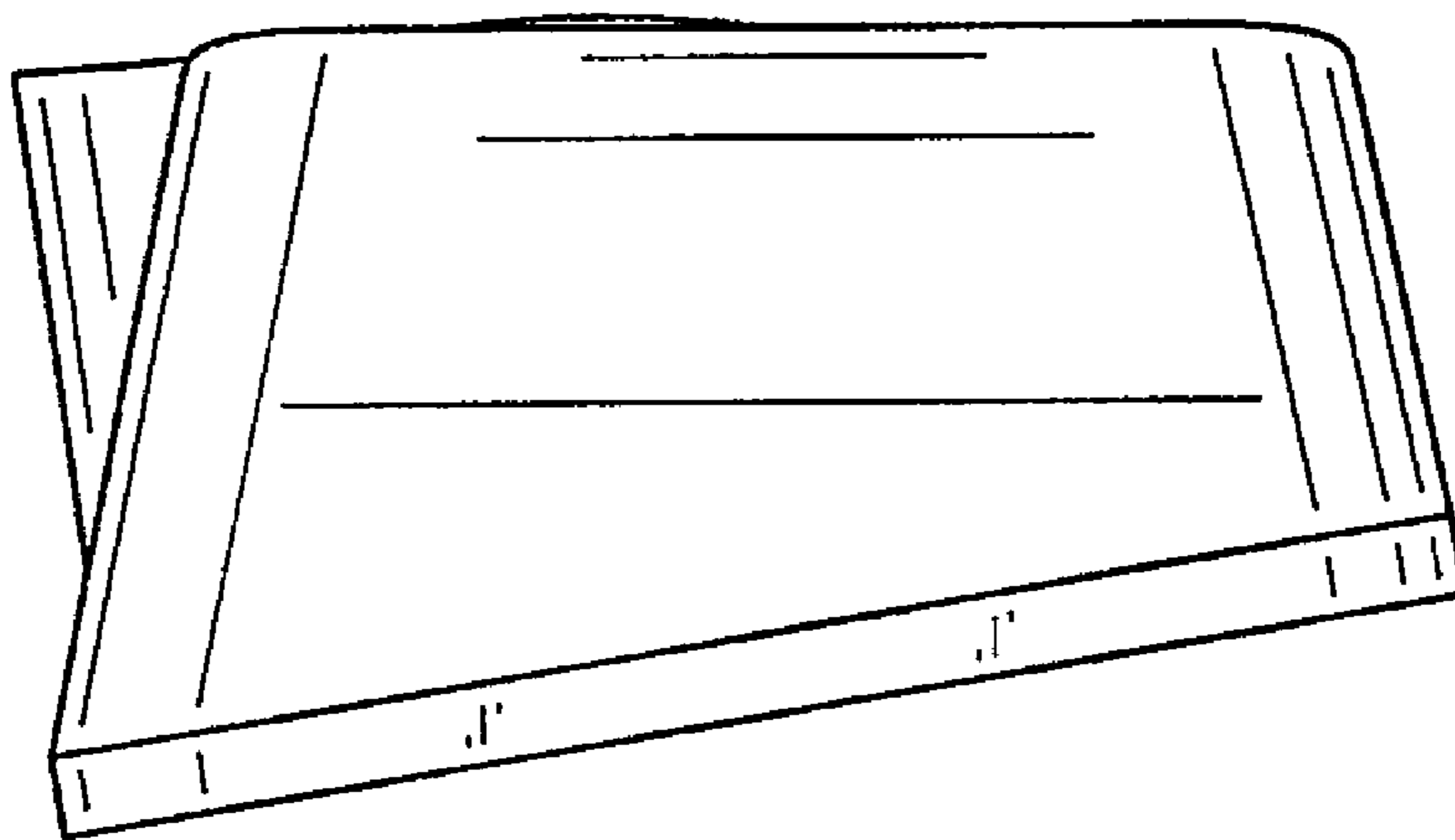

FIG. 11

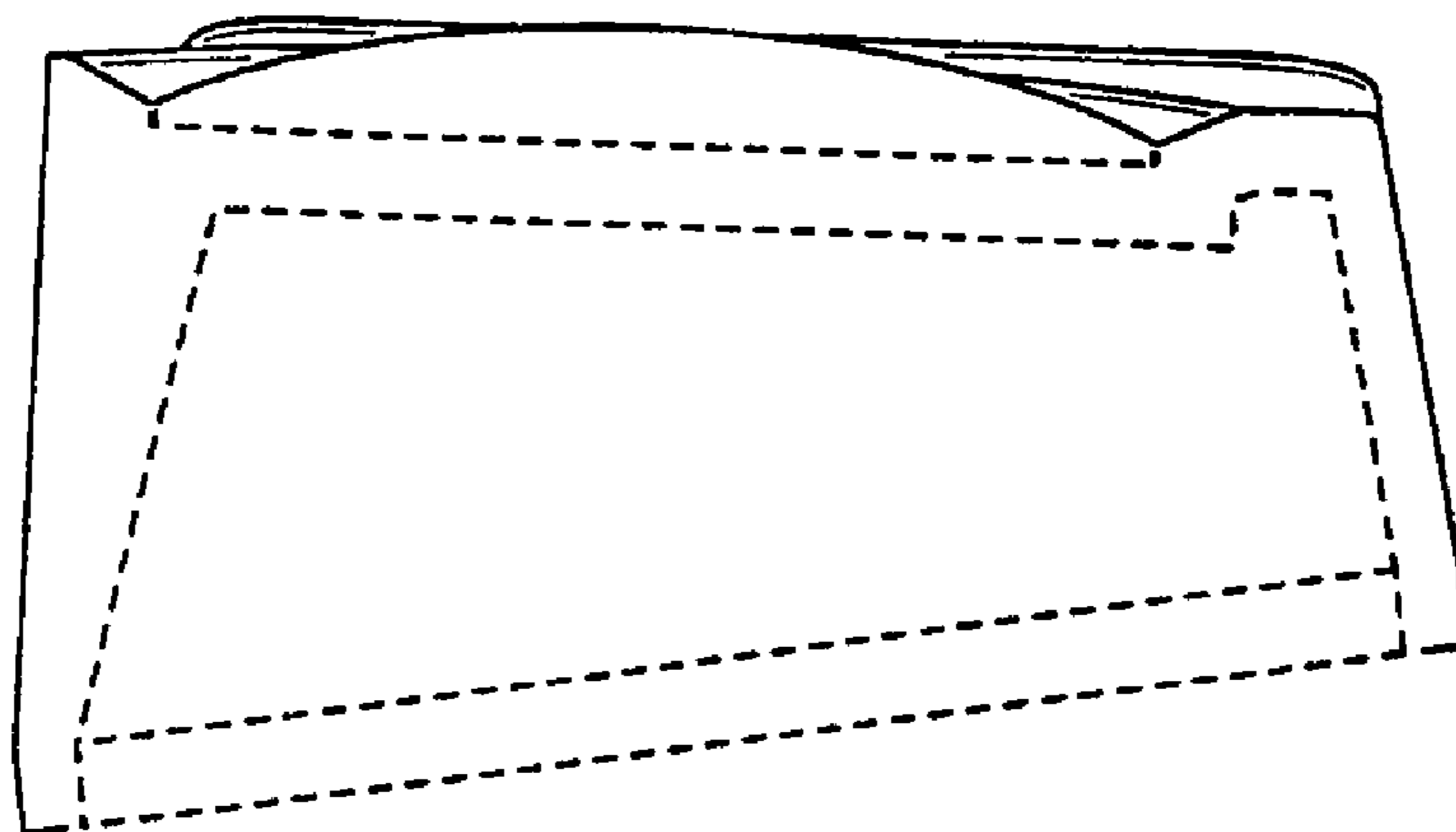

FIG. 12

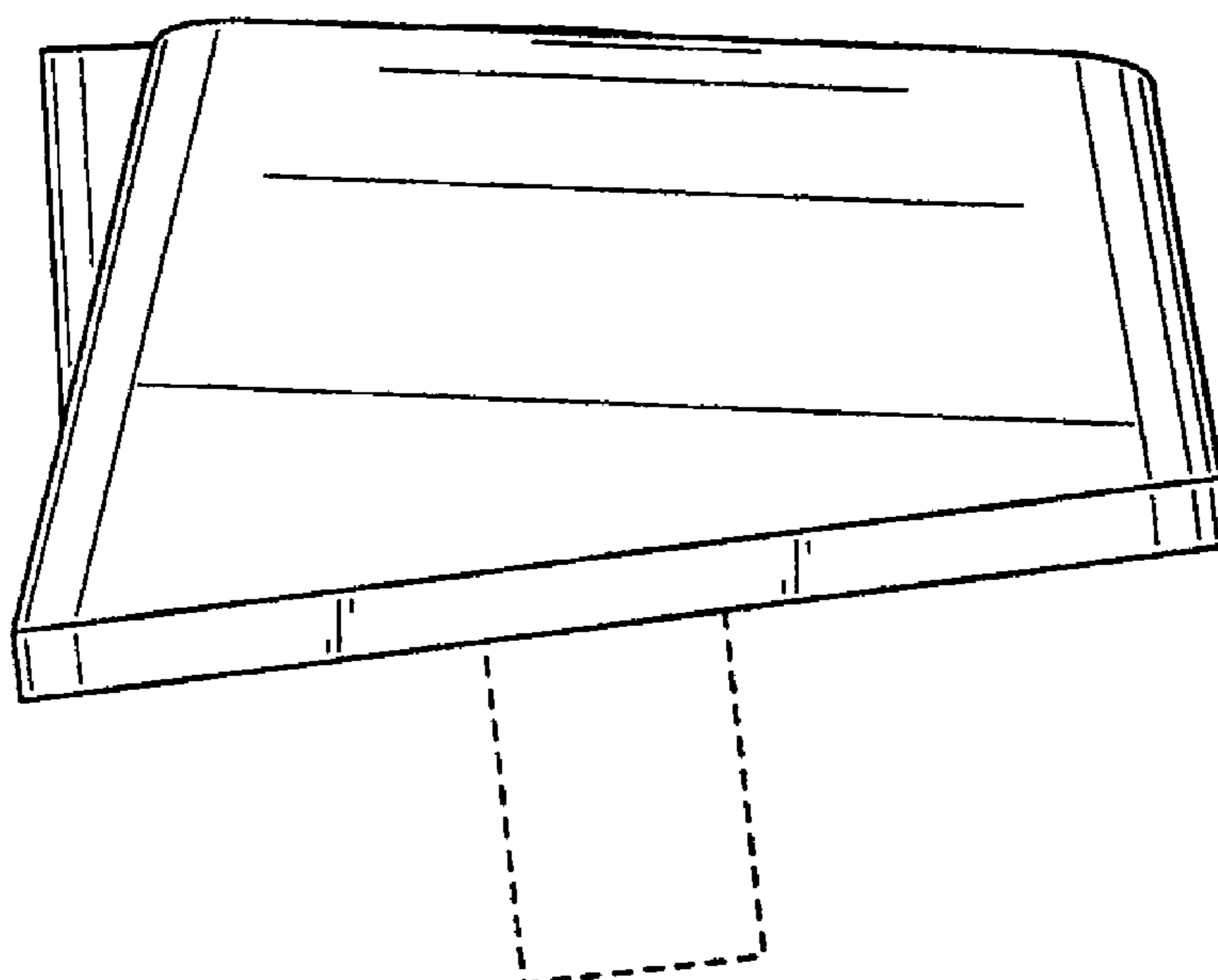

FIG. 13

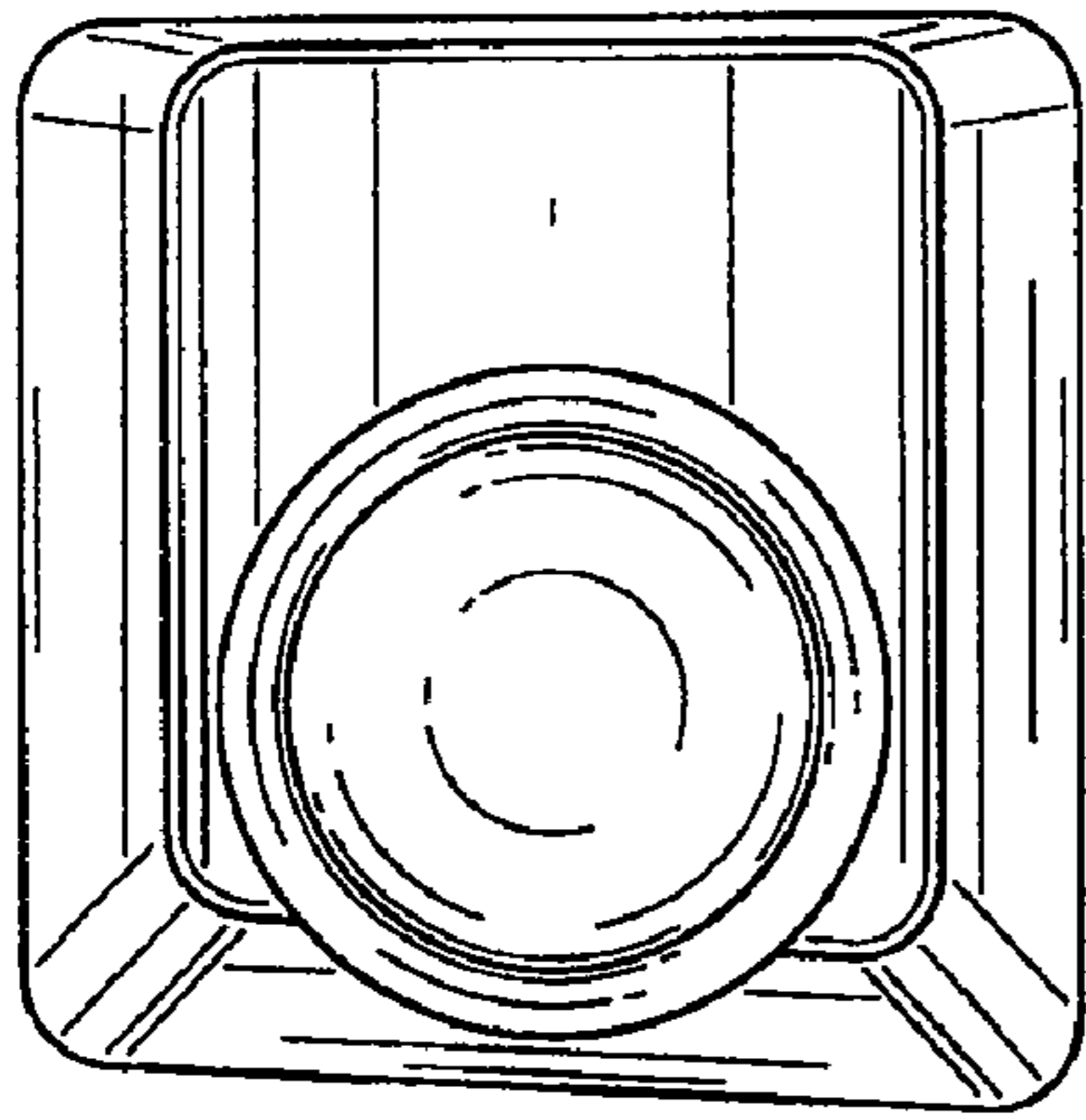

FIG. 14

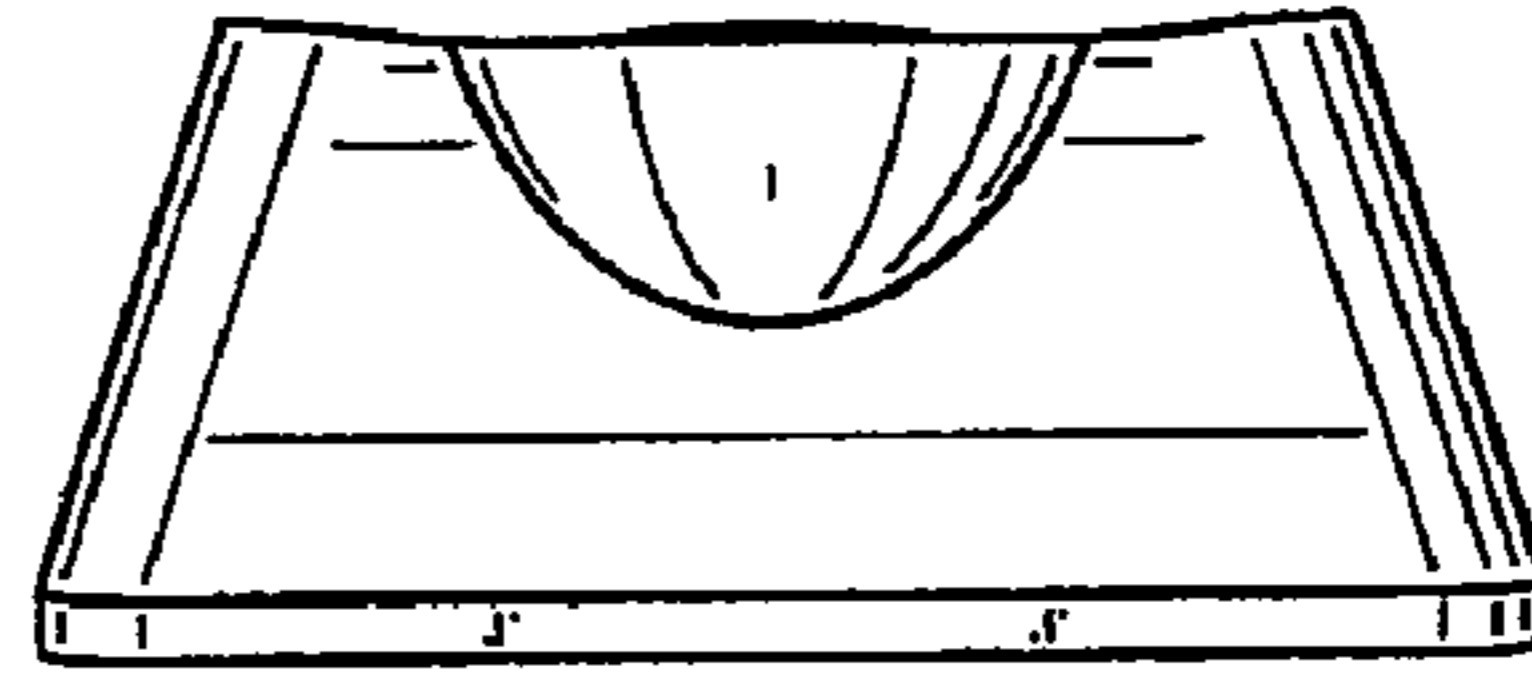

FIG. 15

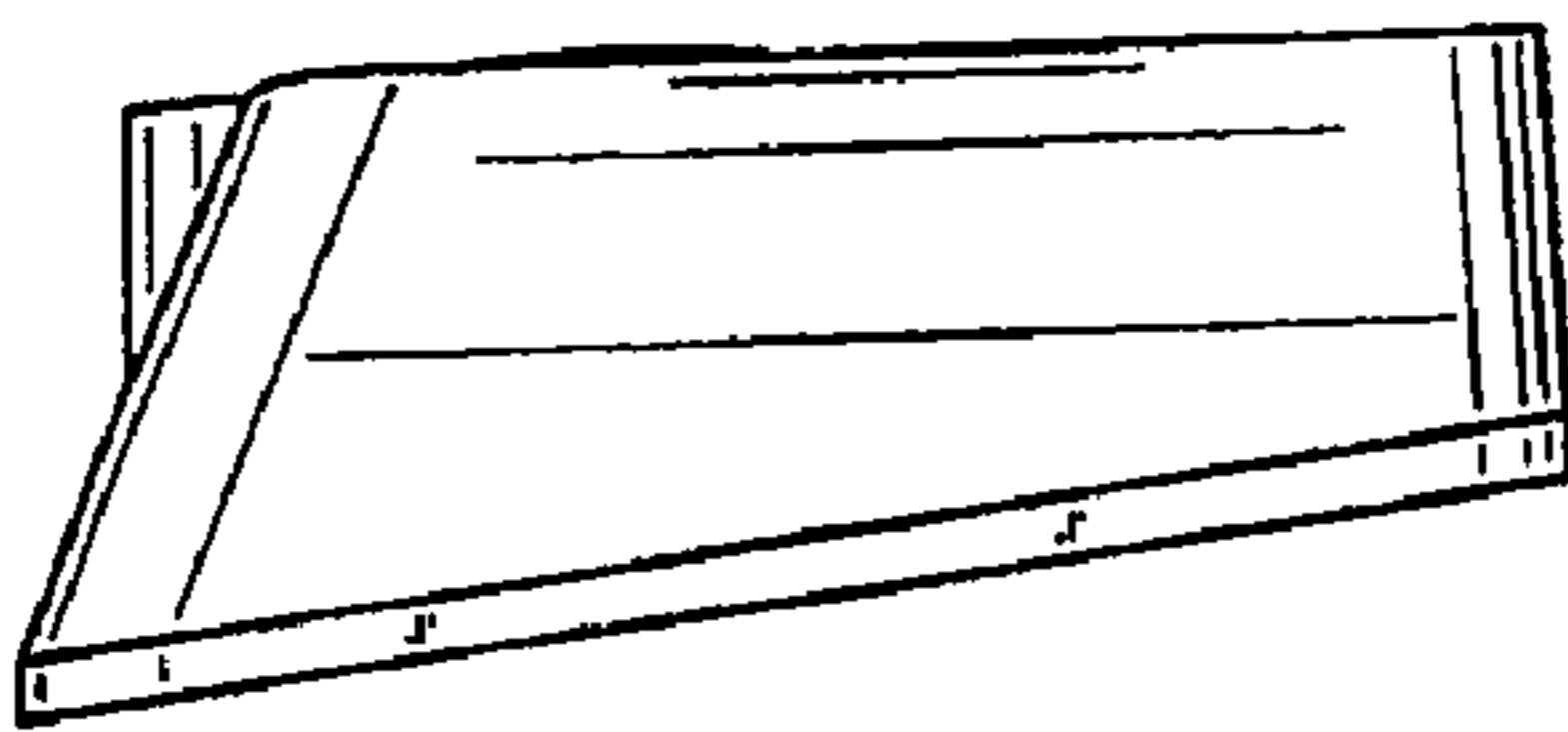

FIG. 16

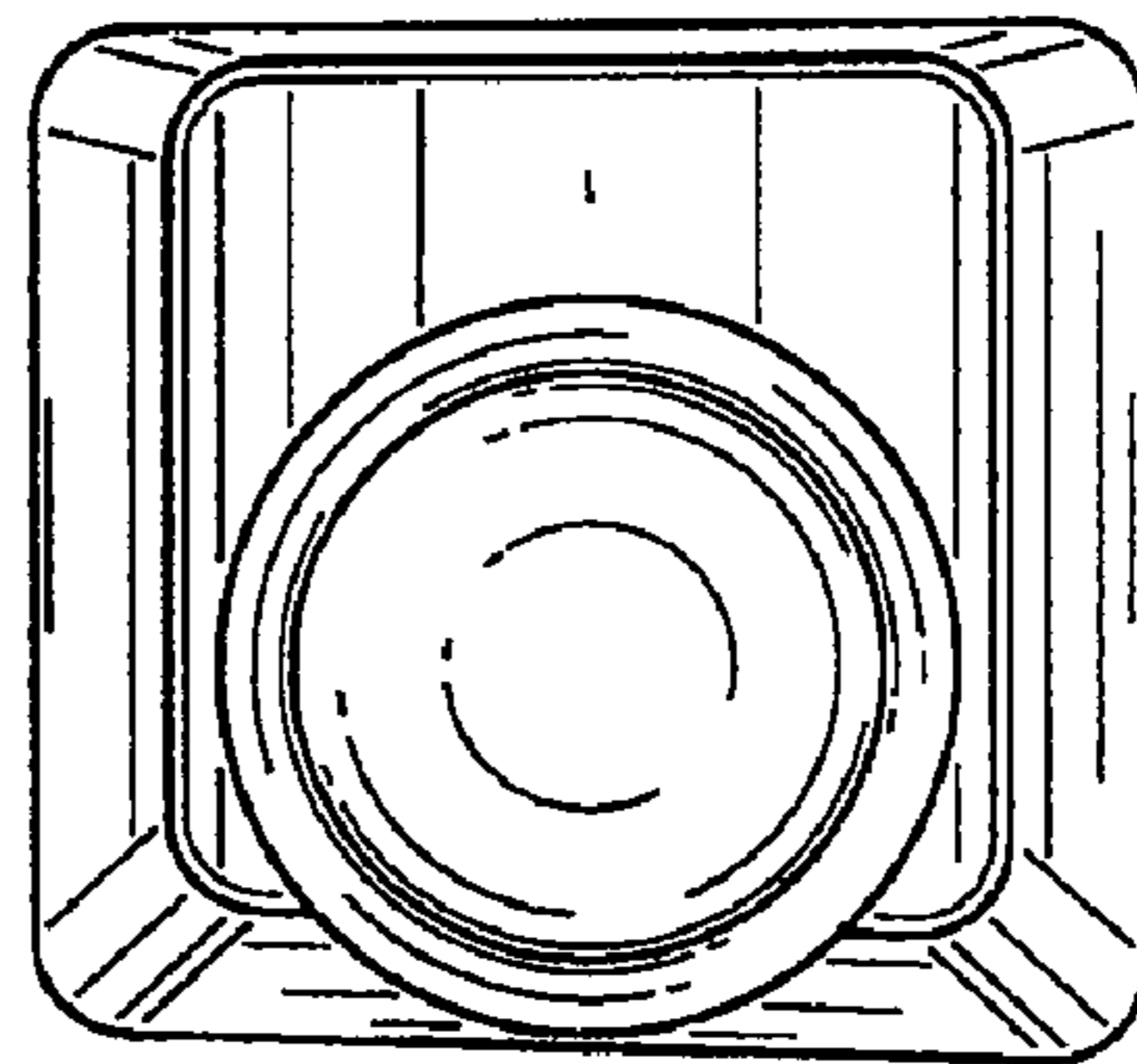

FIG. 17

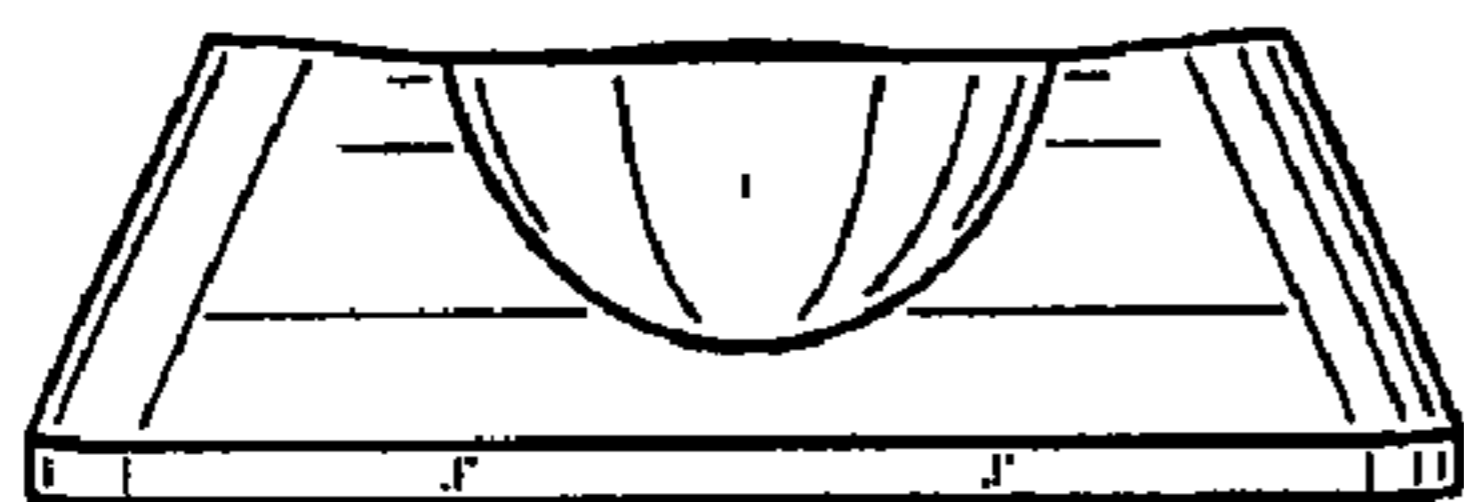

FIG. 18

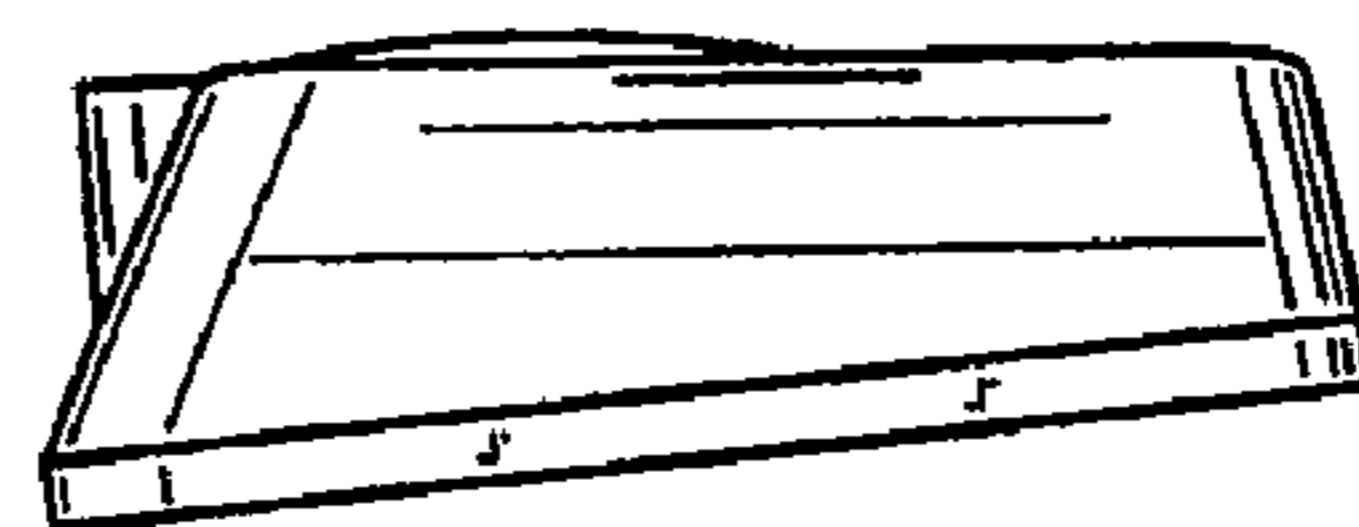

FIG. 19



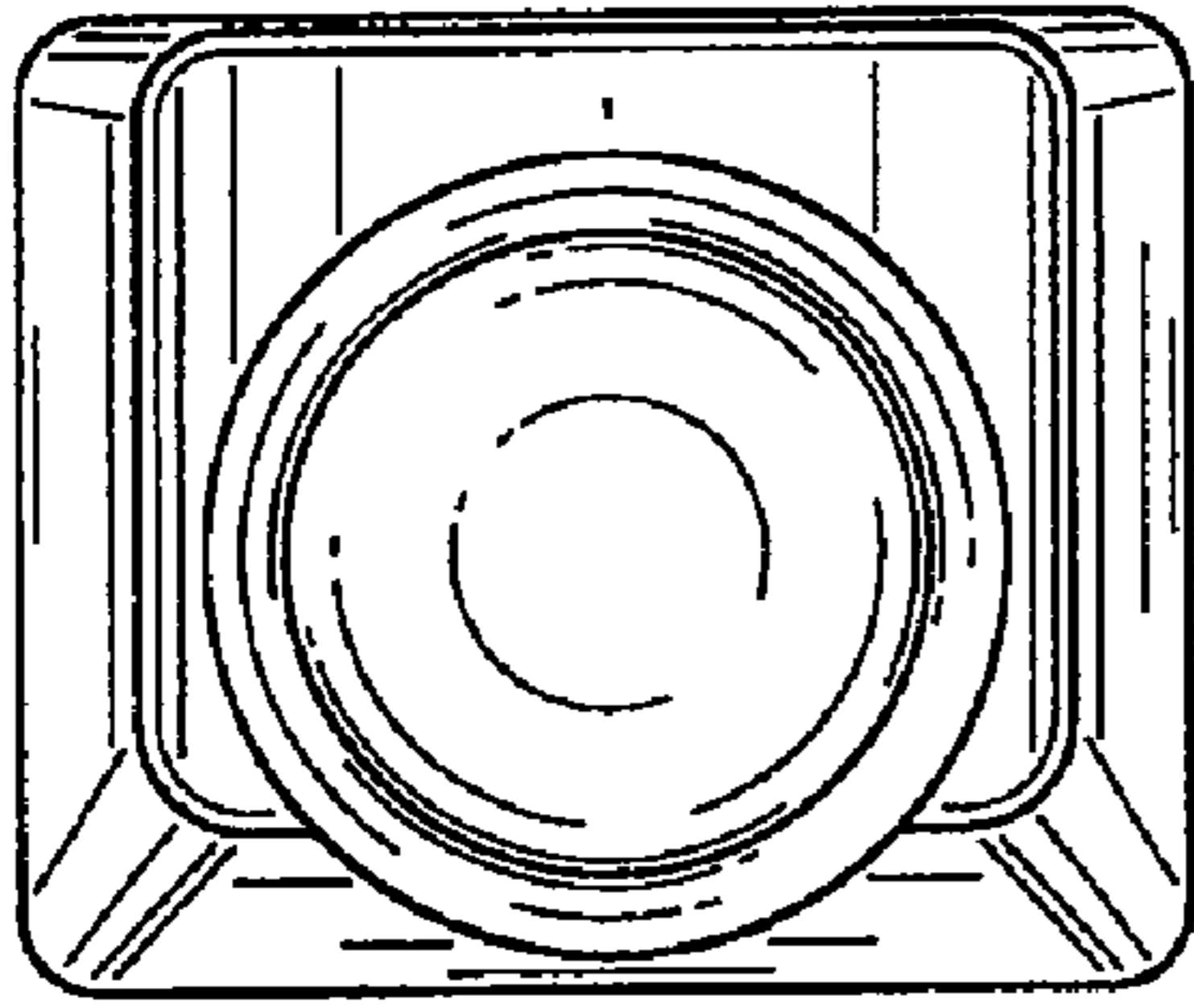

FIG. 20

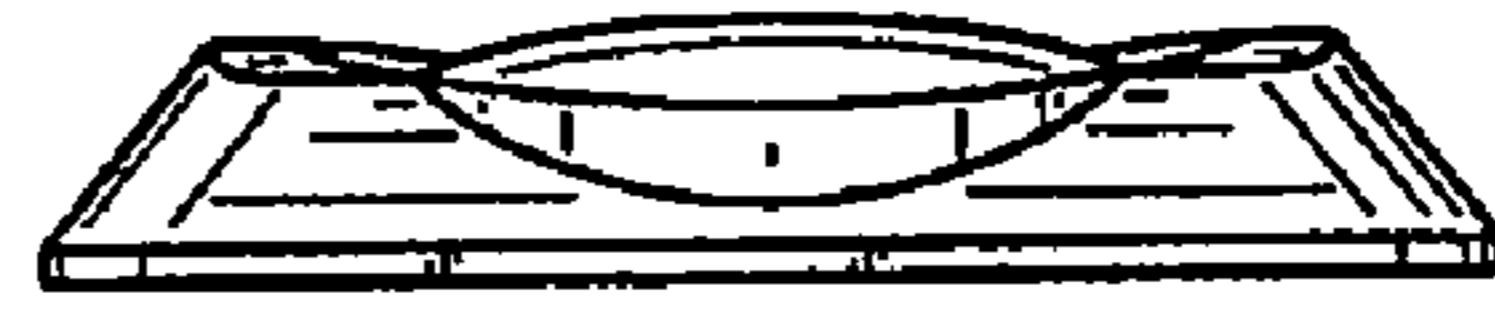

FIG. 21

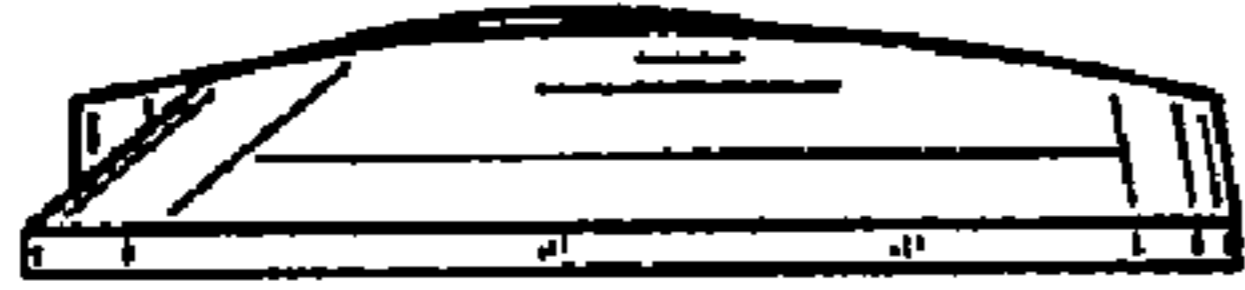

FIG. 22

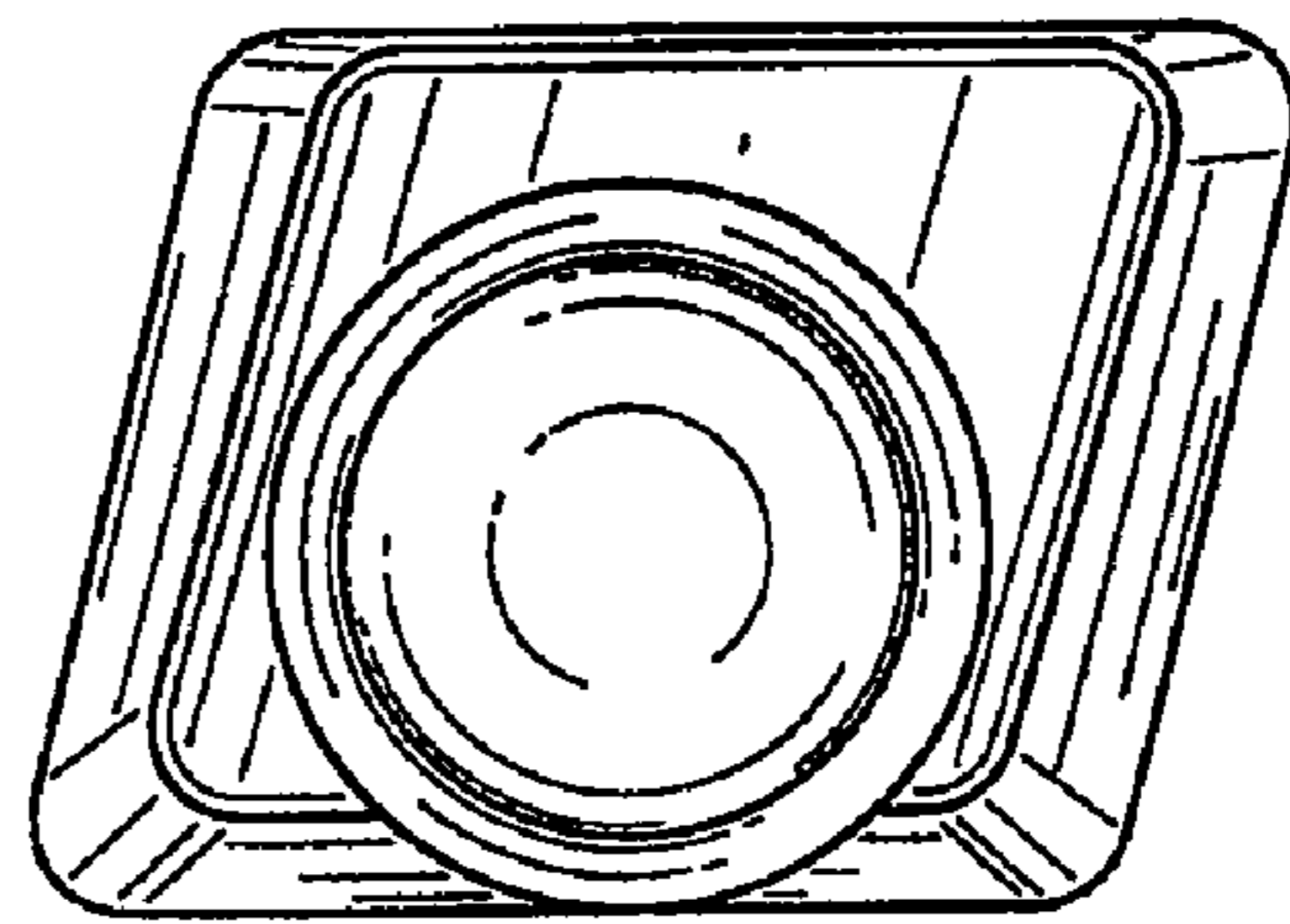

FIG. 23

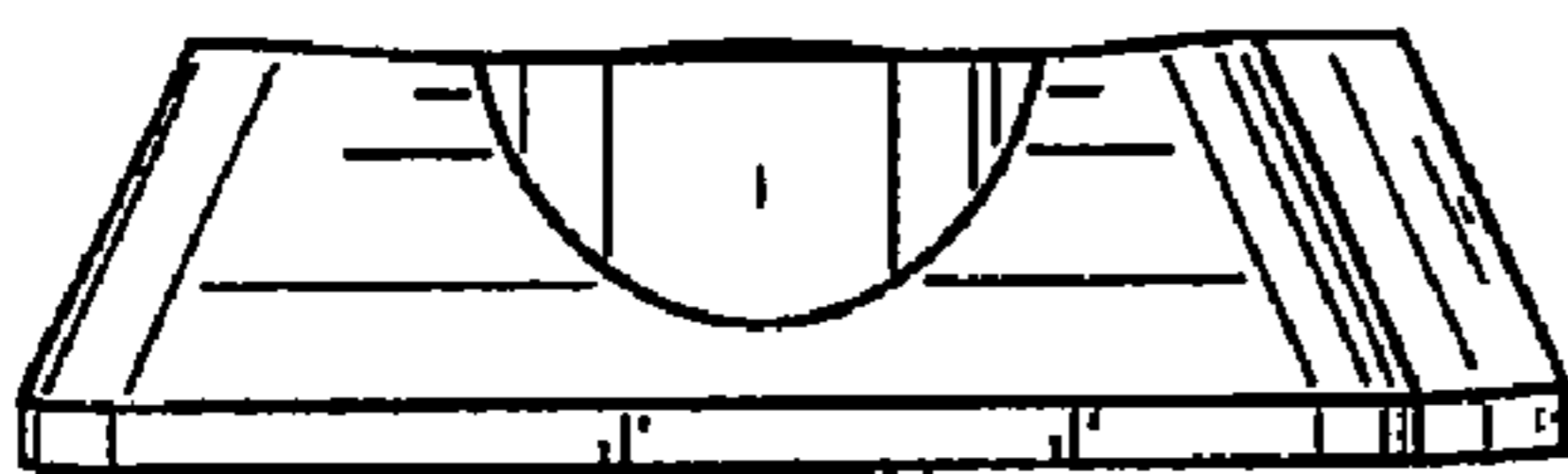

FIG. 24

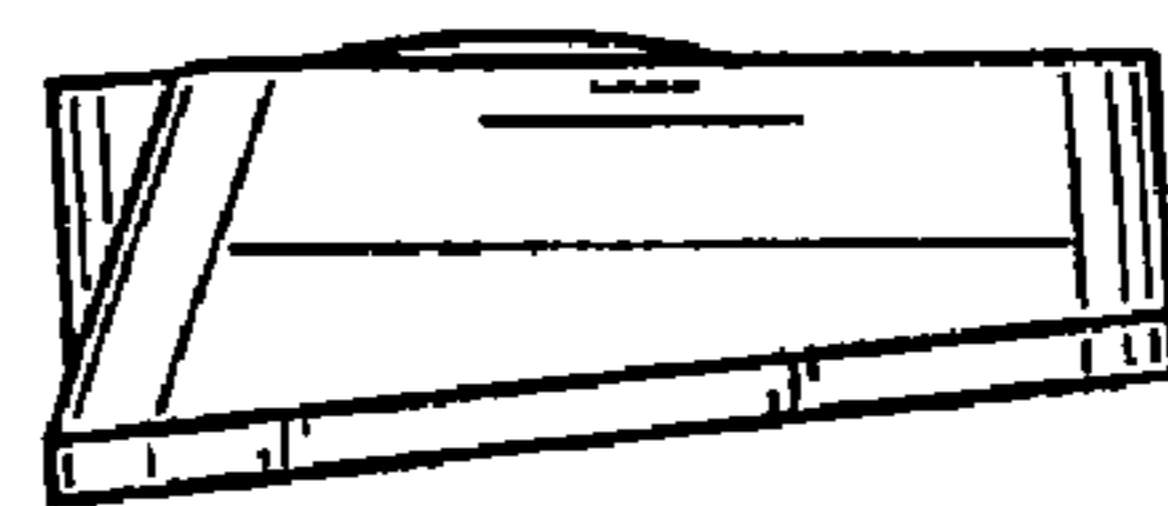

FIG. 25

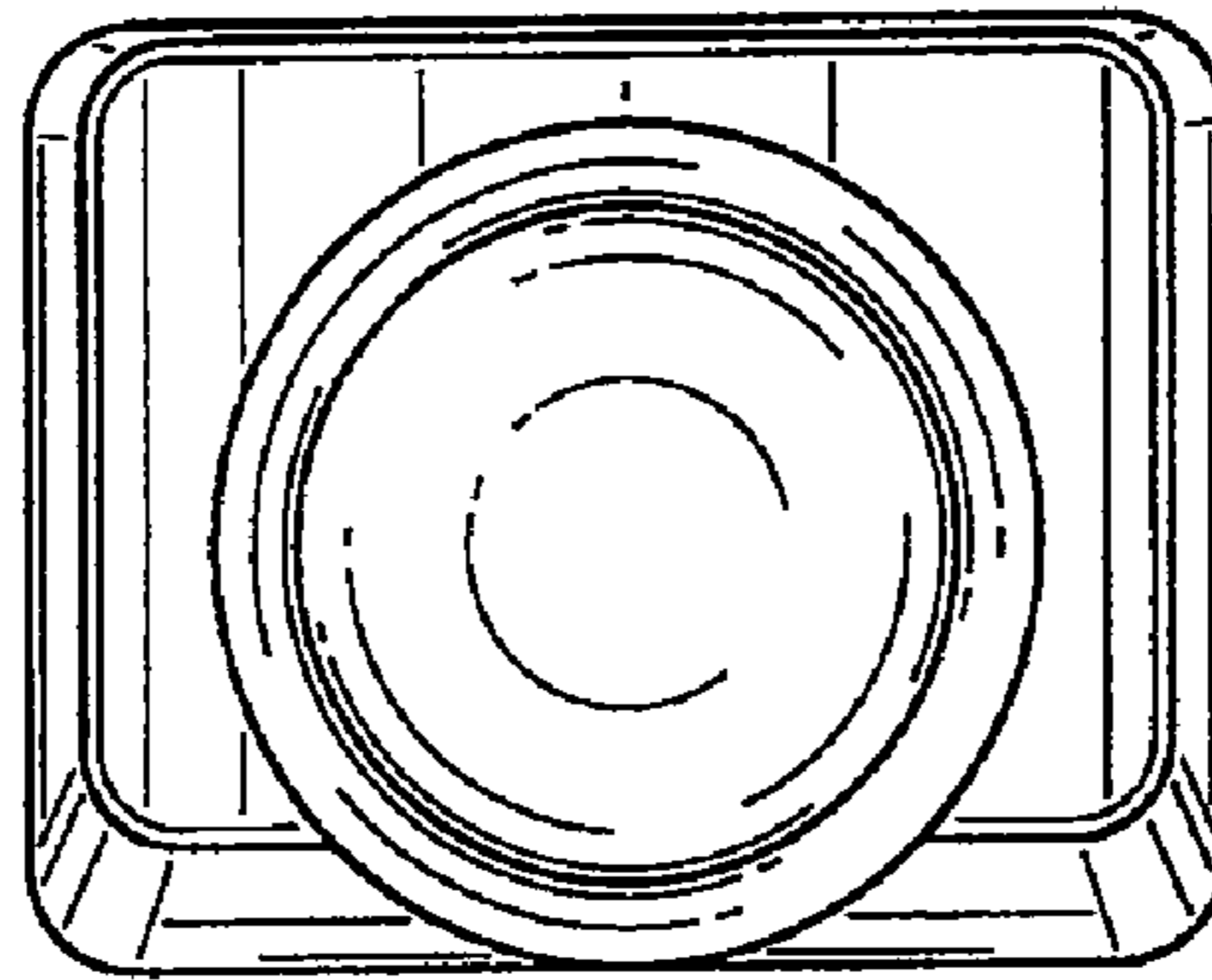

FIG. 26

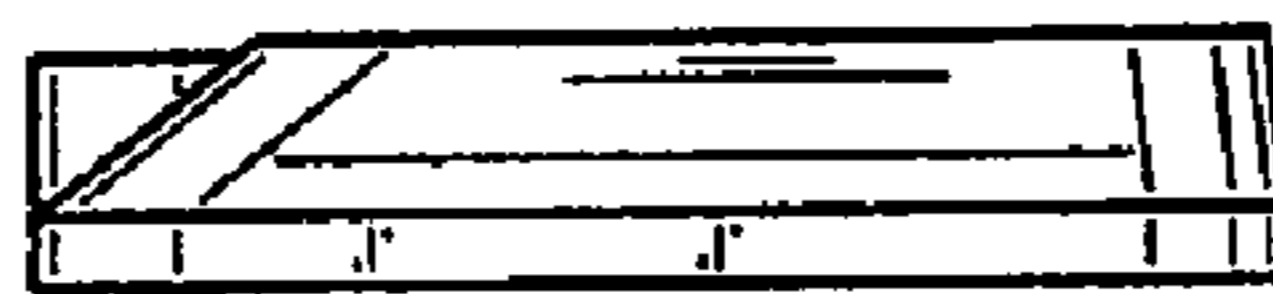

FIG. 27

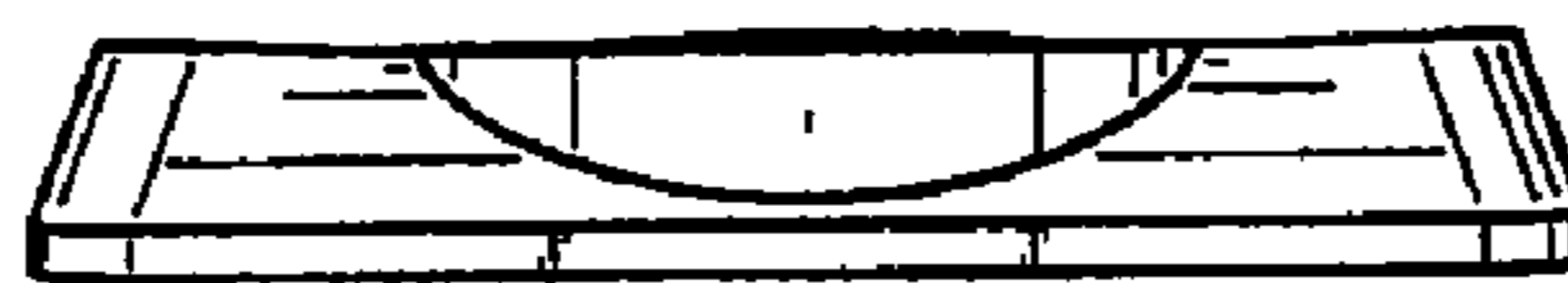

FIG. 28

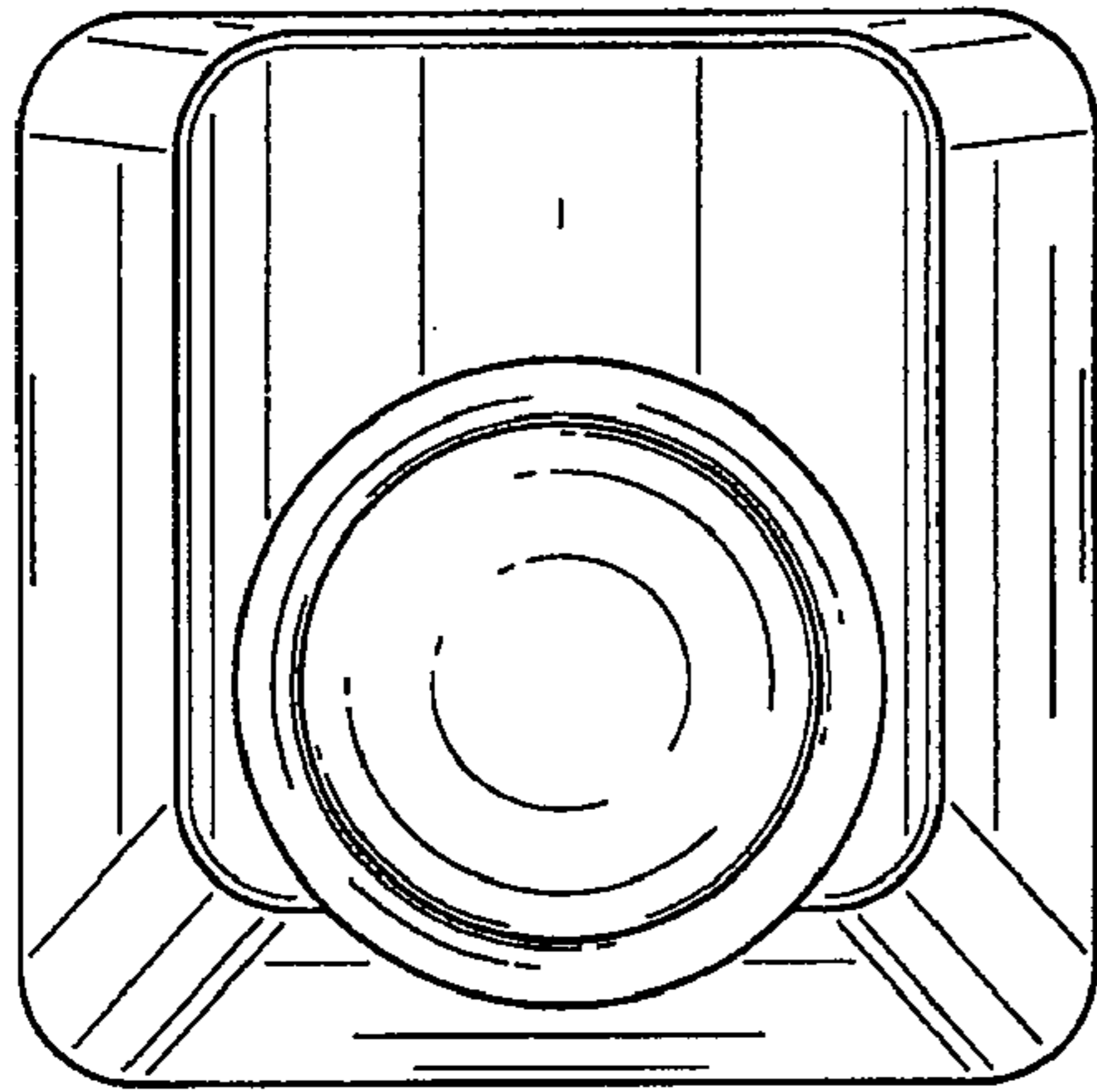

FIG. 29

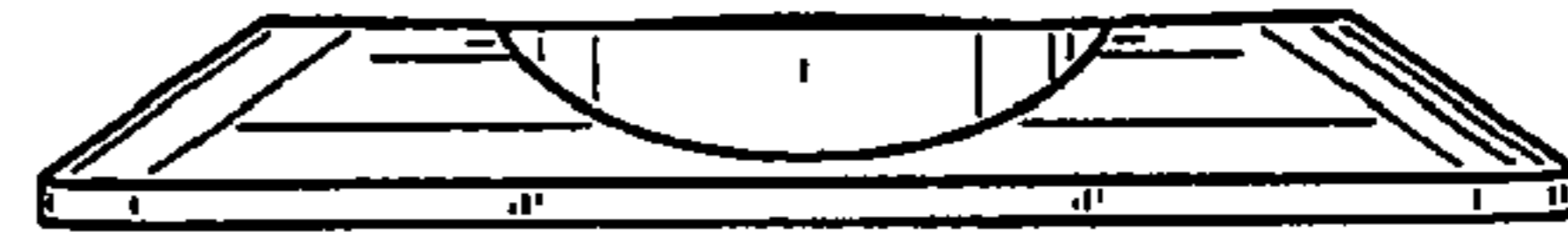

FIG. 30

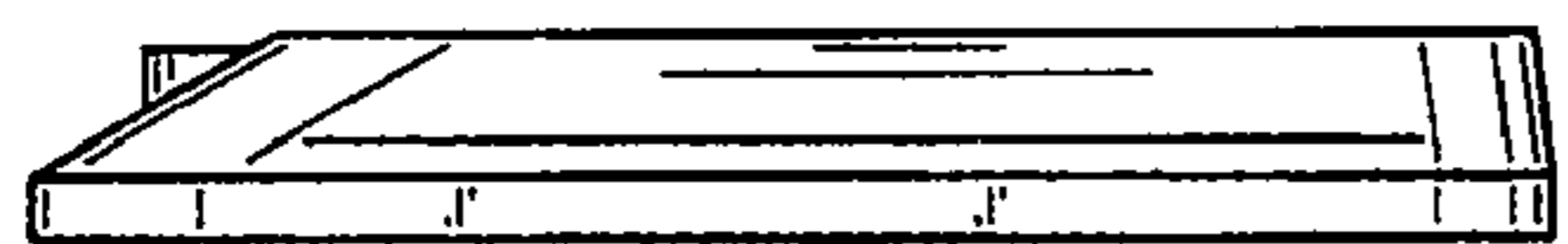

FIG. 31

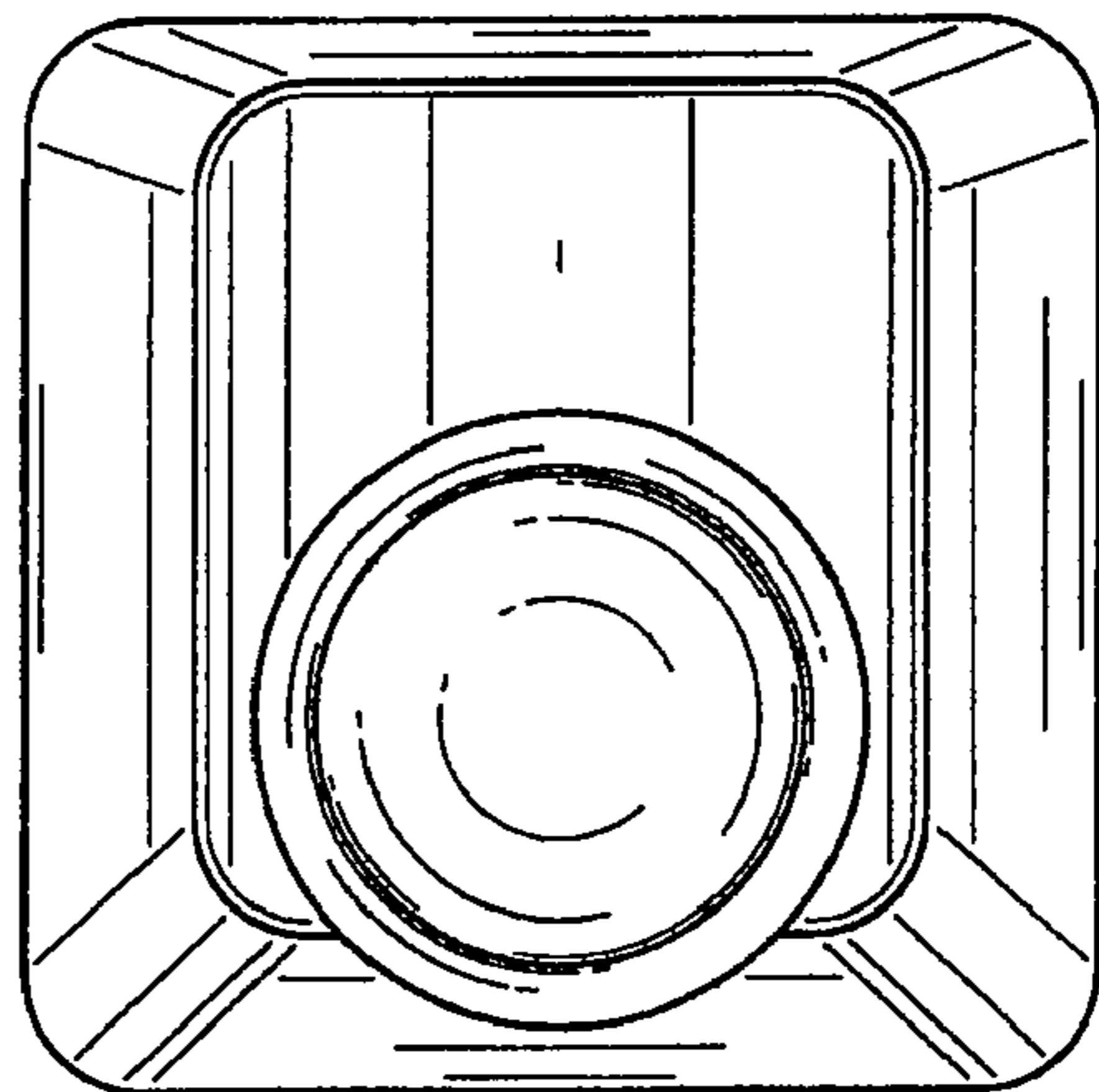

FIG. 32

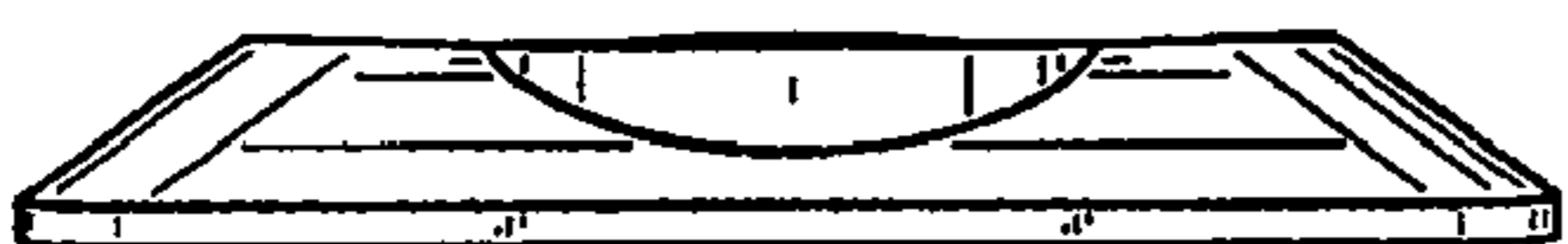

FIG. 33

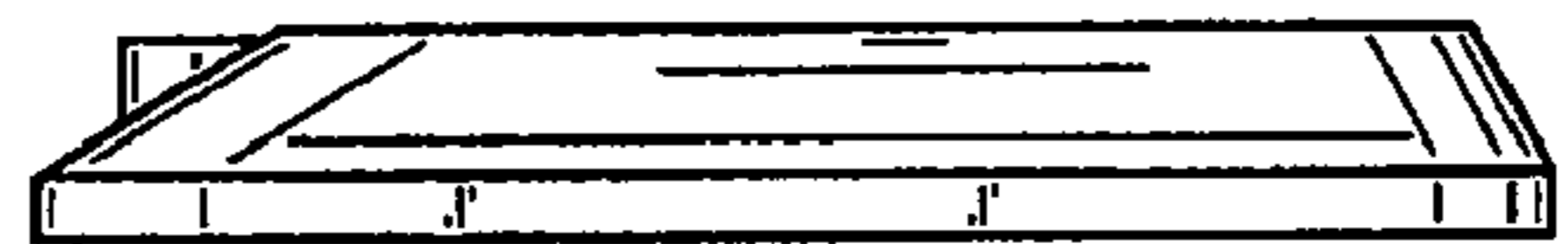

FIG. 34

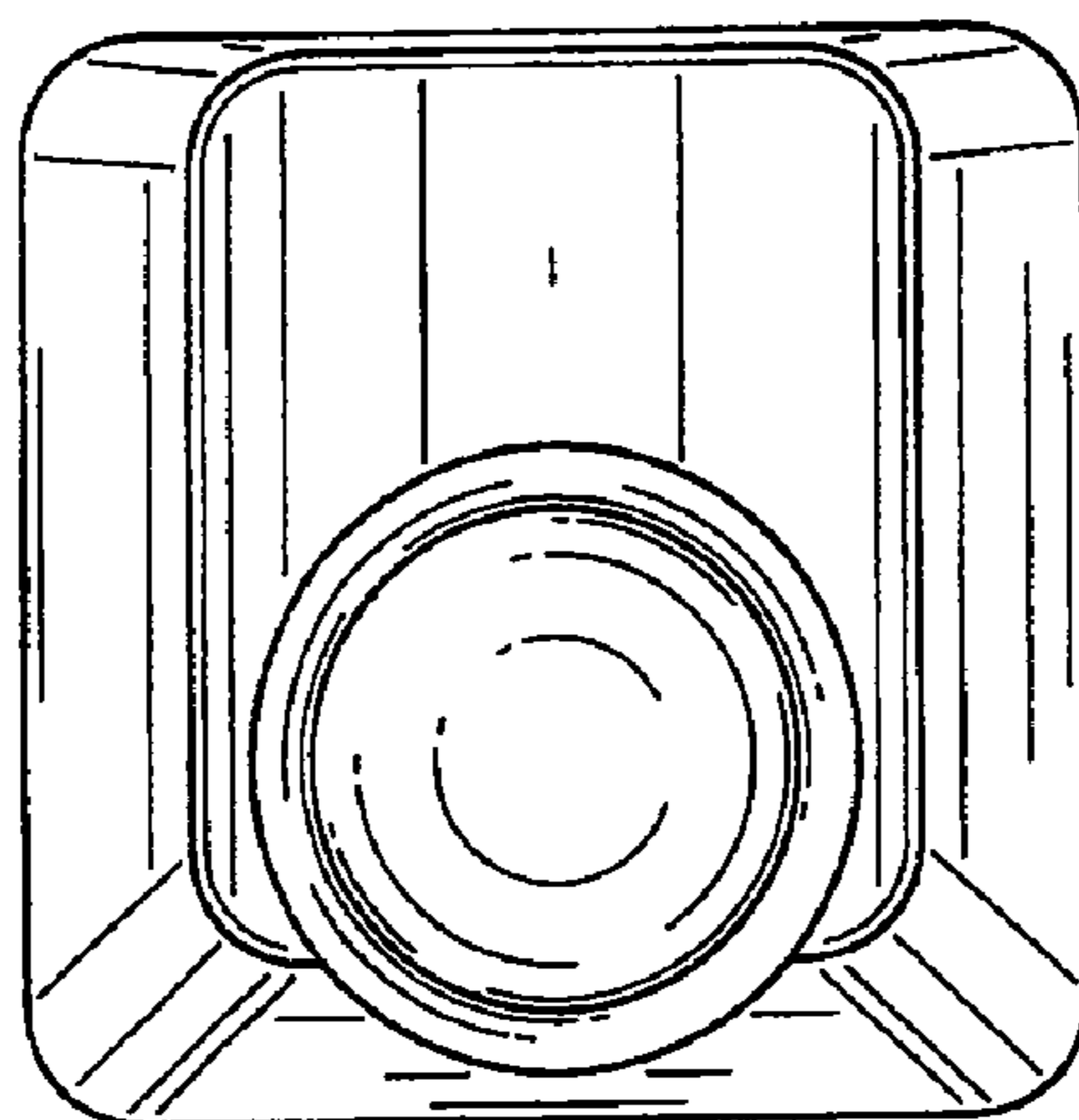

FIG. 35

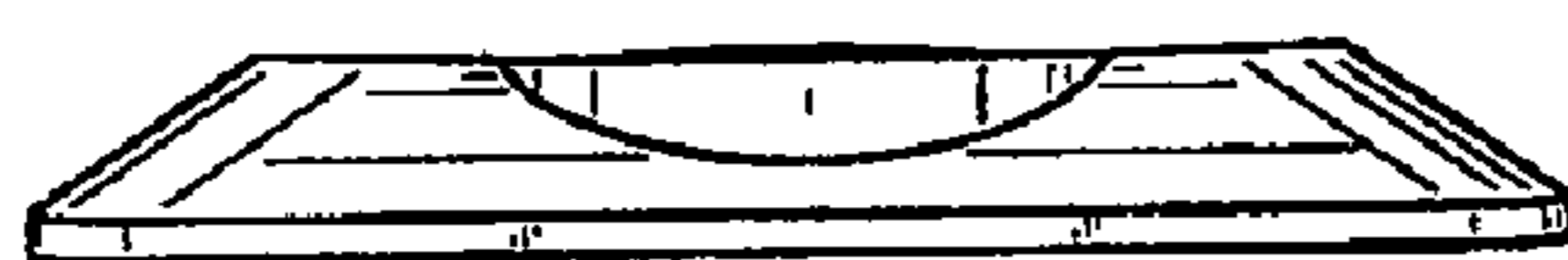

FIG. 36

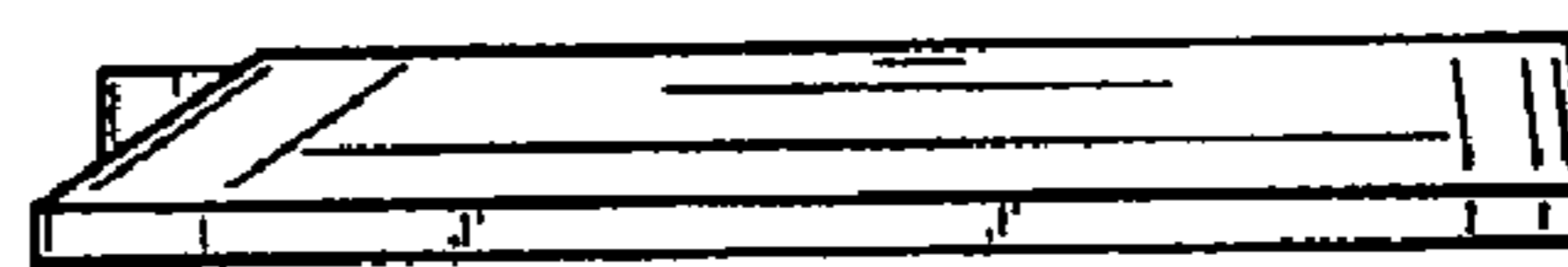

FIG. 37

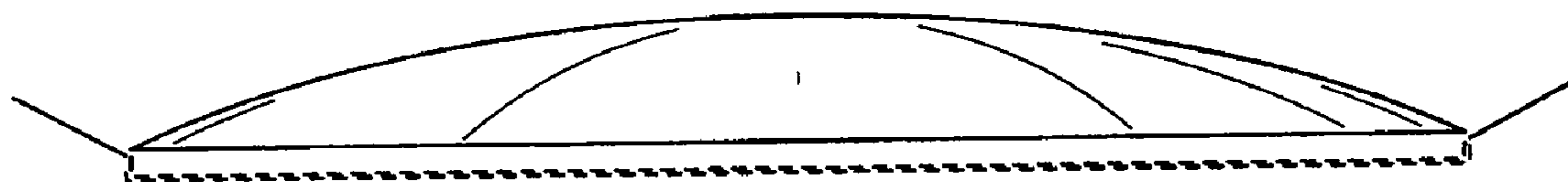

FIG. 38