



US00D585430S

(12) **United States Design Patent**
Kim et al.

(10) **Patent No.:** **US D585,430 S**
(45) **Date of Patent:** **** Jan. 27, 2009**

(54) **HEADSET FOR BLUETOOTH**

(75) Inventors: **Ji Hee Kim**, Gyeonggi-do (KR); **Hyo Gon Kim**, Gyeonggi-do (KR); **Yun Jin Park**, Seoul (KR)

(73) Assignee: **LG Electronics Inc.**, Seoul (KR)

(**) Term: **14 Years**

(21) Appl. No.: **29/290,771**

(22) Filed: **Jan. 11, 2008**

(30) **Foreign Application Priority Data**

Jul. 13, 2007 (KR) 30-2007-0030604

(51) **LOC (9) Cl.** **14-01**

(52) **U.S. Cl.** **D14/223**

(58) **Field of Classification Search** D14/205,
D14/206, 223; 181/129–130; 381/374, 371,
381/370, 377, 378, 379, 380, 381; 379/430,
379/433.01, 433.03, 433.04; 455/575.1,
455/575.2

See application file for complete search history.

(56) **References Cited**

U.S. PATENT DOCUMENTS

6,430,299	B1 *	8/2002	Hall et al.	381/371
6,760,458	B1 *	7/2004	Bogeskov-Jensen et al.	381/370
6,868,284	B2 *	3/2005	Bae	455/575.2
D504,884	S *	5/2005	Hering	D14/206
D517,053	S *	3/2006	Ham	D14/223
D539,787	S *	4/2007	Kim et al.	D14/223
D545,813	S *	7/2007	Ma	D14/223
D550,215	S *	9/2007	Udagawa et al.	D14/223
D552,596	S *	10/2007	Christopher	D14/205

D553,613	S *	10/2007	Sade et al.	D14/223
D555,150	S *	11/2007	Christopher et al.	D14/223
D555,151	S *	11/2007	Eklund	D14/223
D561,743	S *	2/2008	Huang et al.	D14/223
D562,309	S *	2/2008	Choi et al.	D14/223
D562,310	S *	2/2008	Moon et al.	D14/223
D566,108	S *	4/2008	Kan	D14/223
D566,692	S *	4/2008	Sade et al.	D14/223
D566,694	S *	4/2008	Kim et al.	D14/223
D568,301	S *	5/2008	Kim et al.	D14/223
D569,842	S *	5/2008	Yang	D14/205
D573,582	S *	7/2008	Ma	D14/205
D574,366	S *	8/2008	Sade et al.	D14/223
D574,367	S *	8/2008	Jaakkola et al.	D14/223

* cited by examiner

Primary Examiner—Paula Greene

(74) *Attorney, Agent, or Firm*—Morgan, Lewis & Bockius LLP

(57) **CLAIM**

The ornamental design for a headset for bluetooth, as shown and described.

DESCRIPTION

FIG. 1 is a perspective view of a headset for bluetooth showing our new design;

FIG. 2 is a front view thereof;

FIG. 3 is a rear view thereof;

FIG. 4 is a left side view thereof;

FIG. 5 is a right side view thereof;

FIG. 6 is a top plan view thereof; and,

FIG. 7 is a bottom plan view thereof.

1 Claim, 6 Drawing Sheets

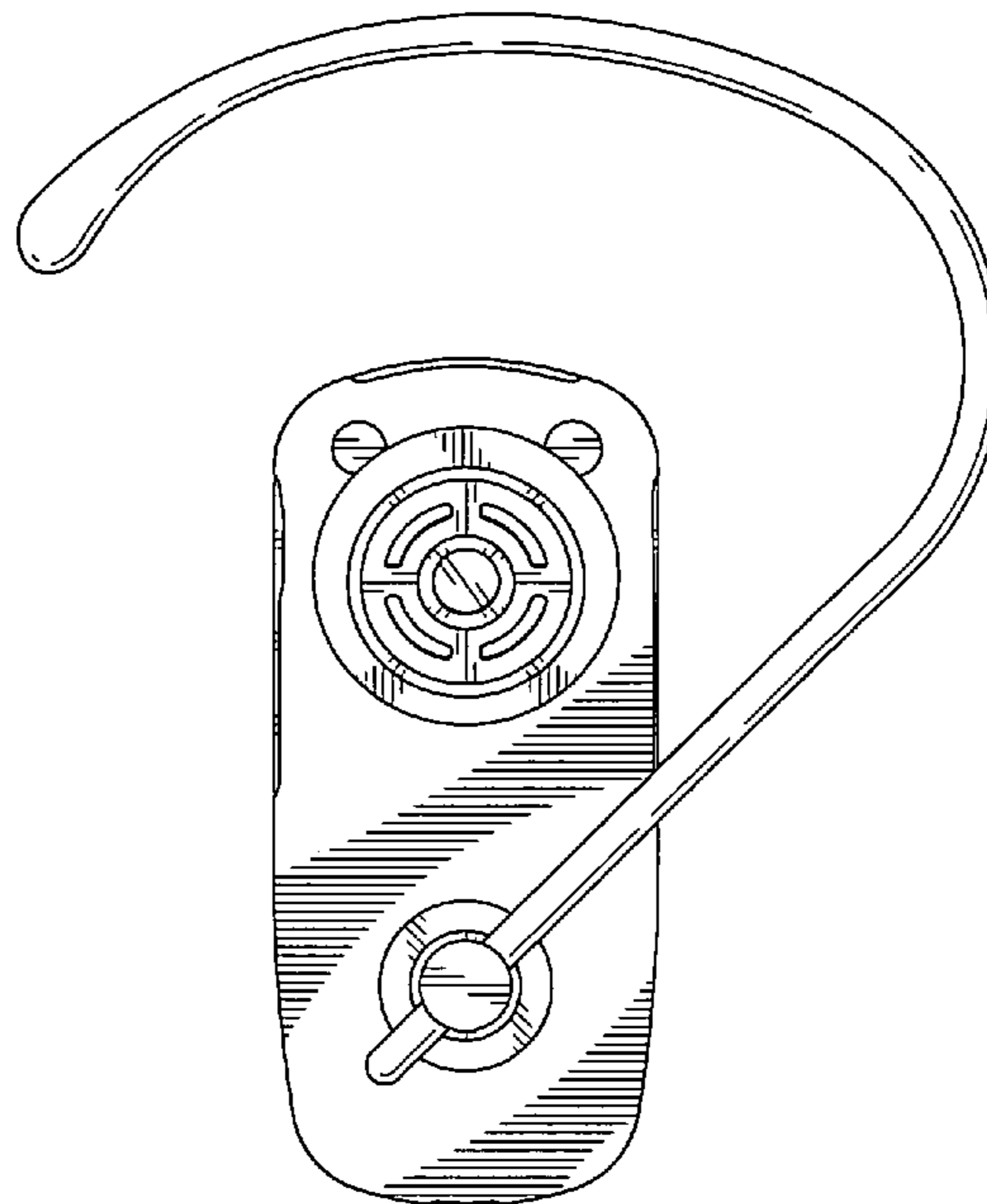
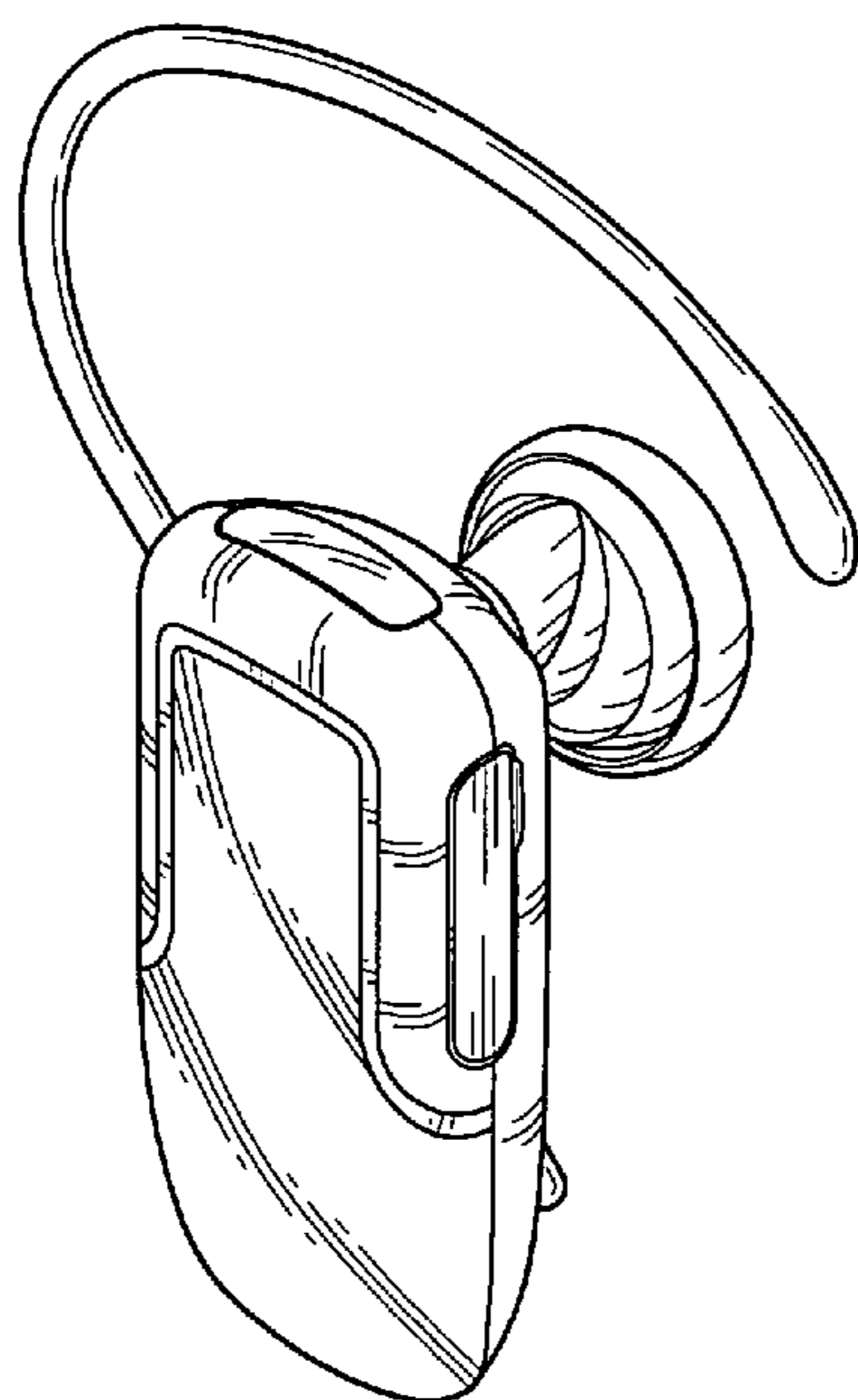

FIG. 1

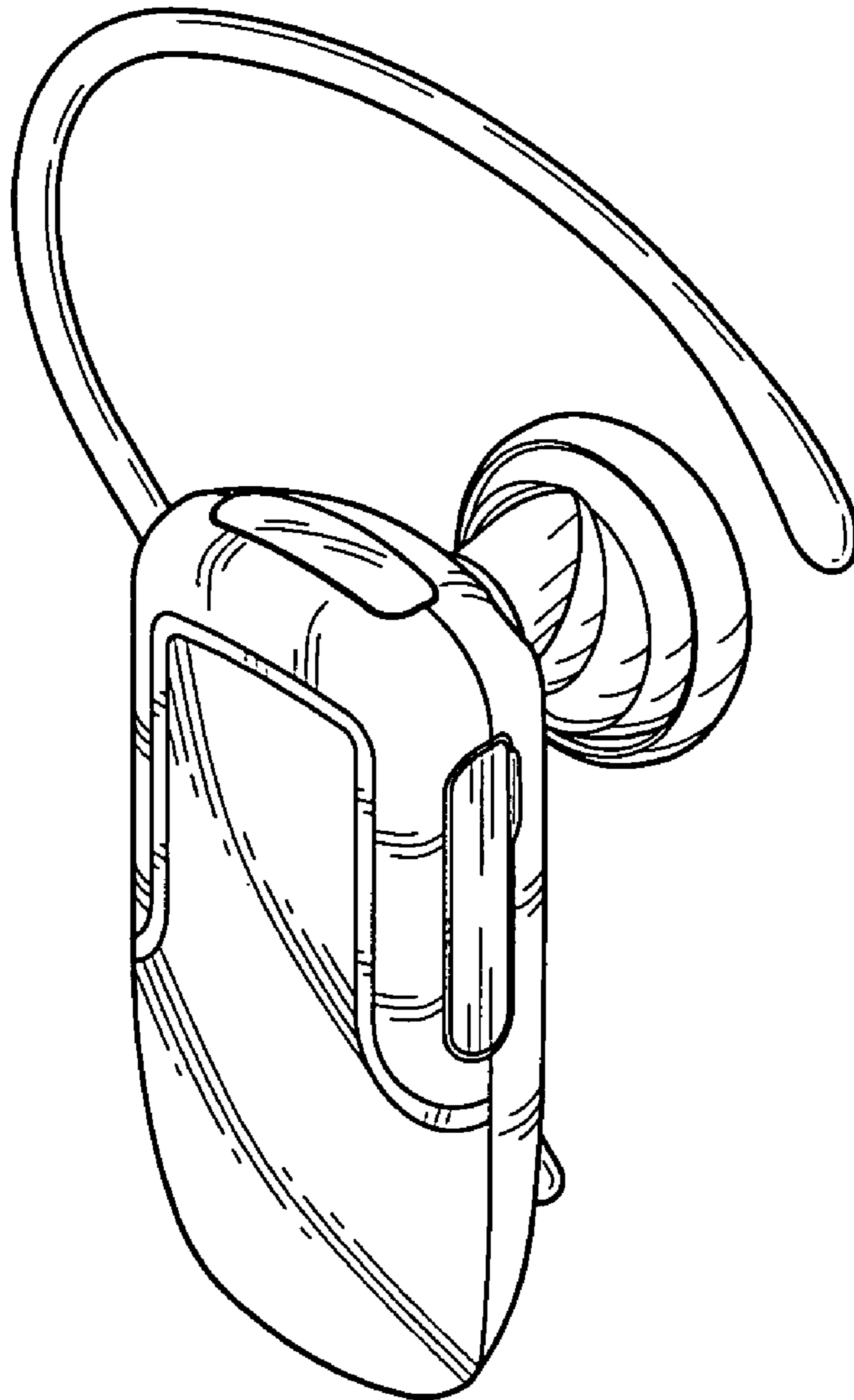

FIG. 2

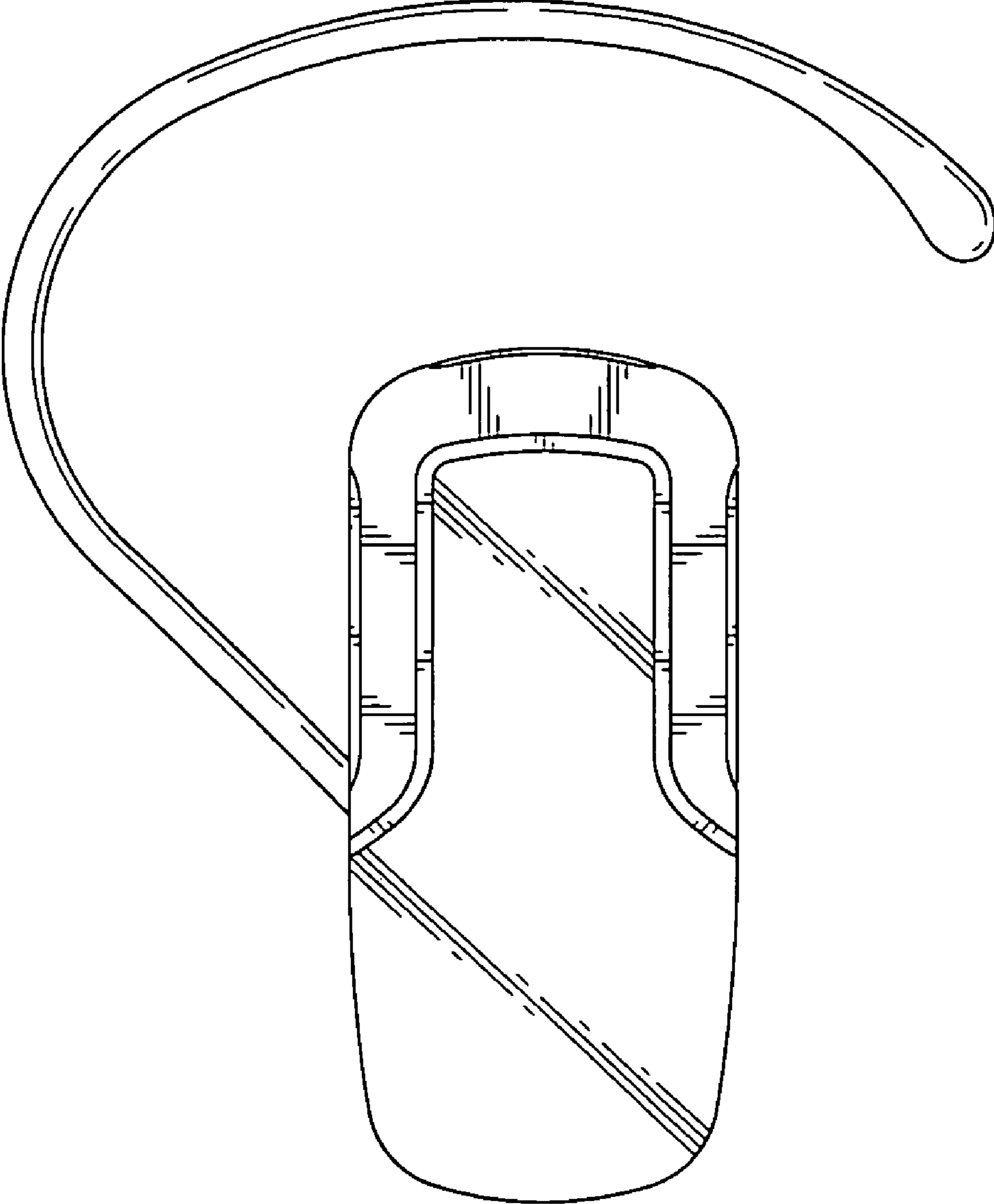

FIG. 3

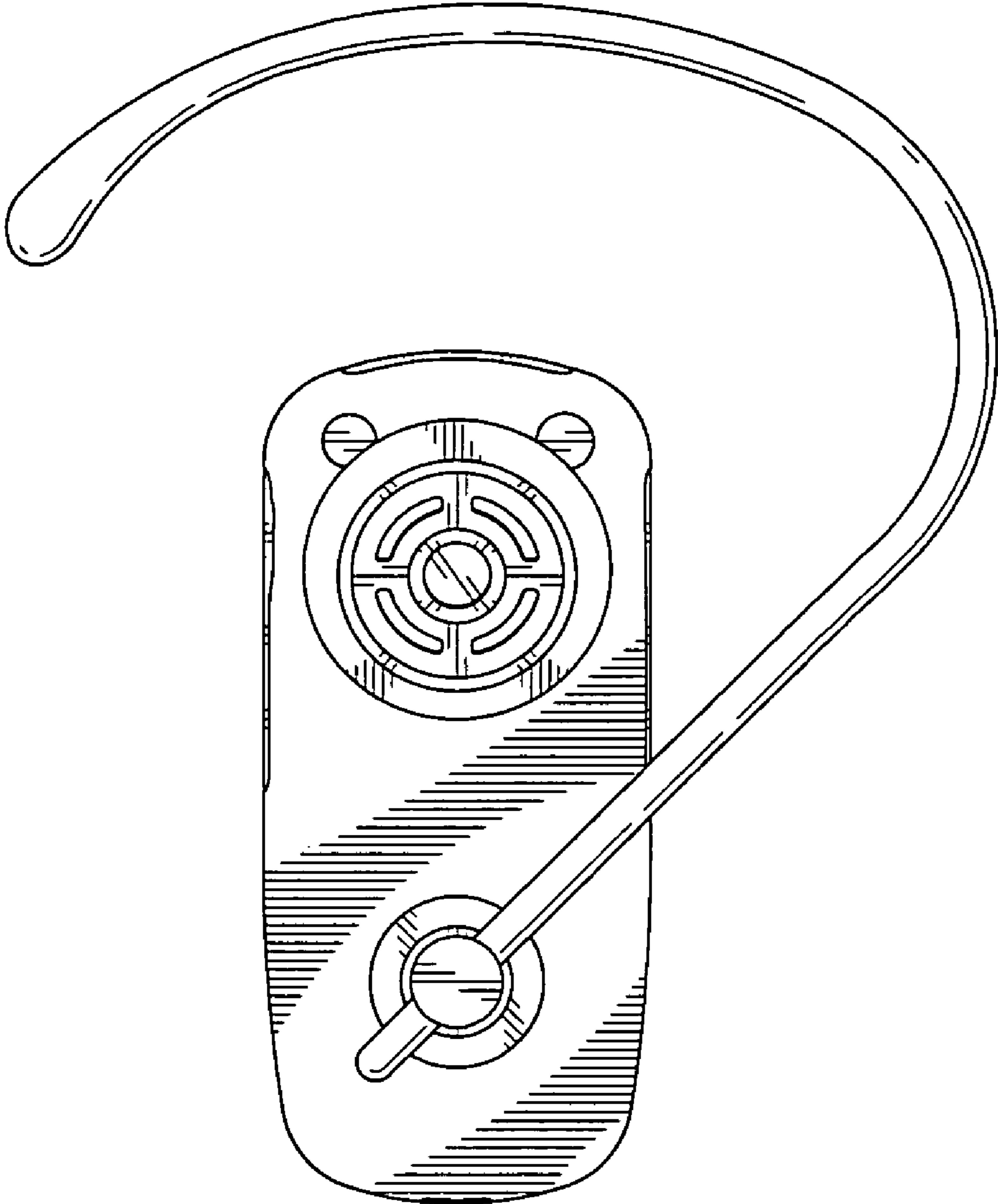

FIG. 4

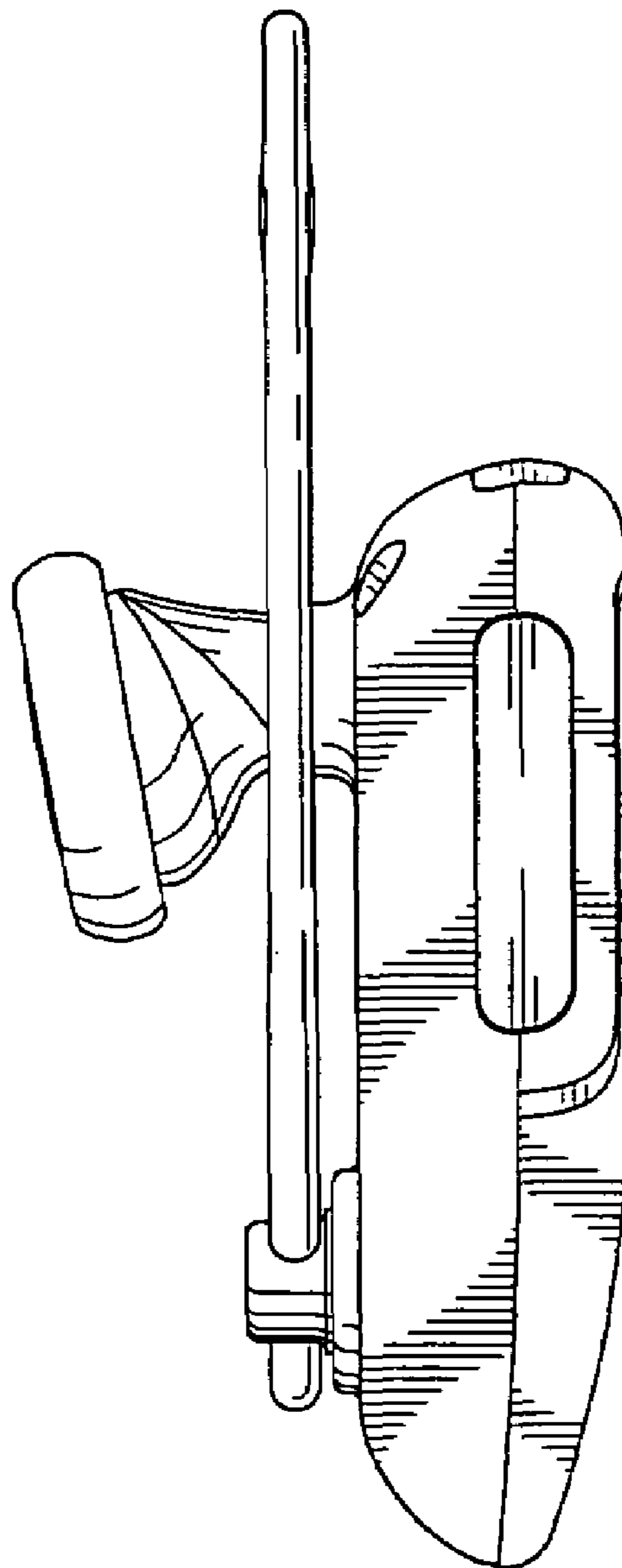

FIG. 5

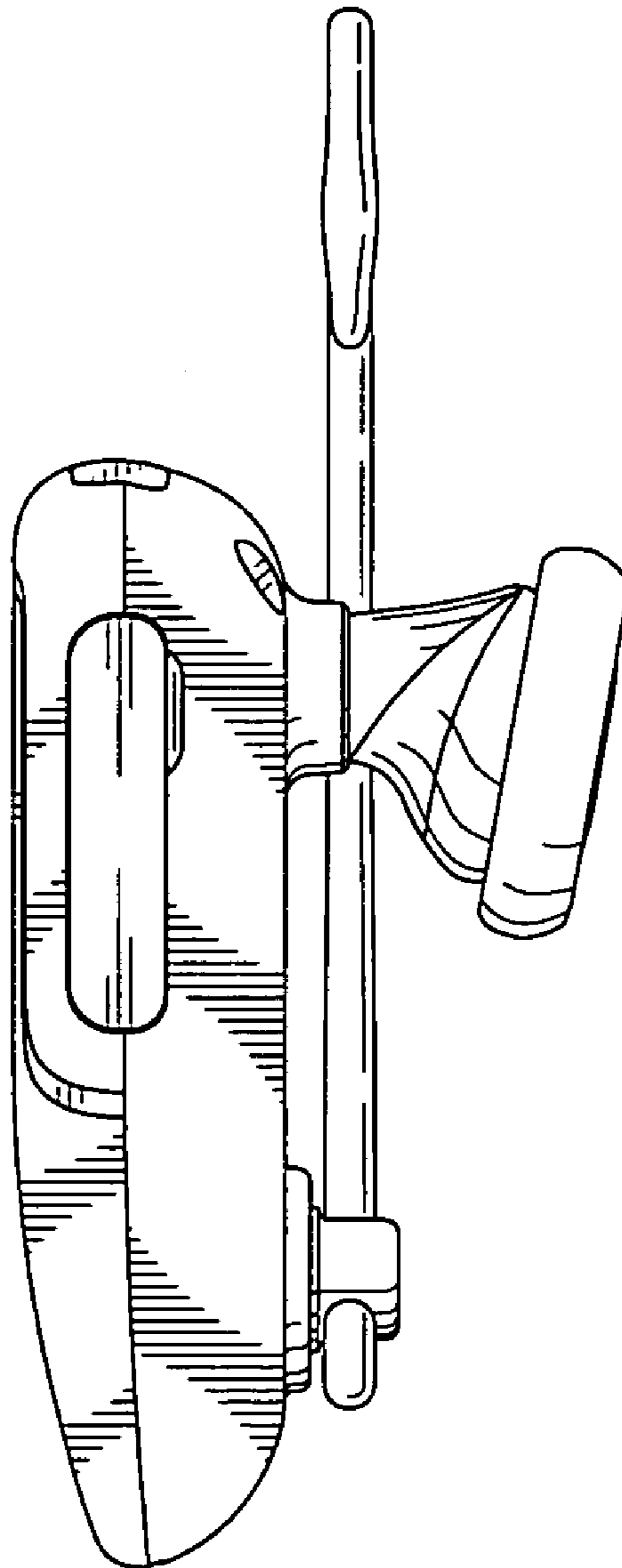

FIG. 6

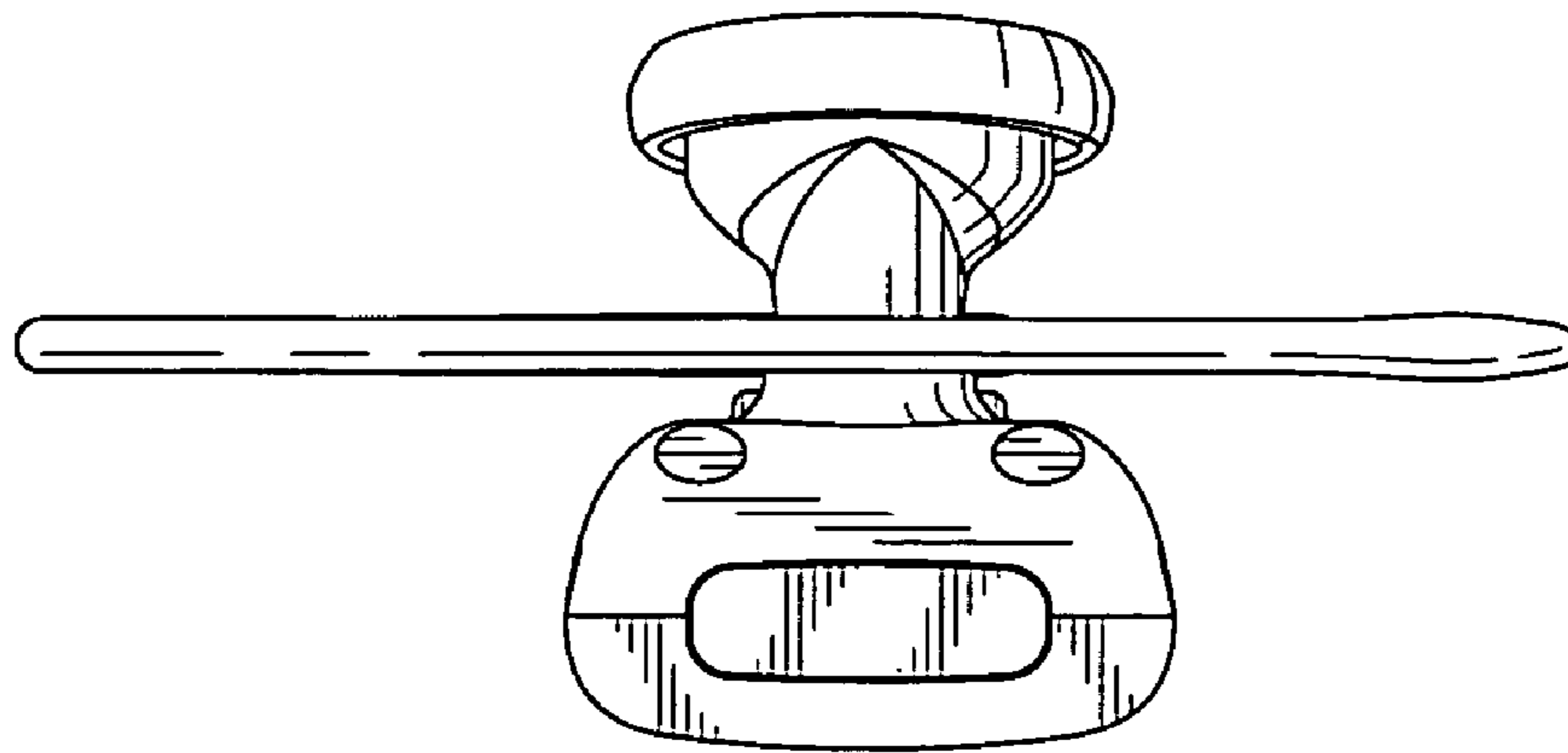

FIG. 7

