



US00D585424S

(12) **United States Design Patent**
Yoneda

(10) **Patent No.:** **US D585,424 S**
(45) **Date of Patent:** **** Jan. 27, 2009**

(54) **SPEAKER BOX**

(75) Inventor: **Naofumi Yoneda**, Tokyo (JP)

(73) Assignee: **Sony Corporation**, Tokyo (JP)

(**) Term: **14 Years**

(21) Appl. No.: **29/271,149**

(22) Filed: **Jan. 11, 2007**

(30) **Foreign Application Priority Data**

Sep. 11, 2006 (JP) 2006-024185

(51) **LOC (9) Cl.** **14-01**

(52) **U.S. Cl.** **D14/216**

(58) **Field of Classification Search** D14/204,
D14/207, 210-216, 170-172; 181/143-144,
181/147-148, 150-153, 157, 198-199; 381/300-303,
381/306, 332-333, 336, 345, 361-364, 386-388
See application file for complete search history.

(56) **References Cited**

U.S. PATENT DOCUMENTS

4,942,939 A * 7/1990 Harrison 181/156
D359,285 S * 6/1995 Niblett D14/170

D437,843 S 2/2001 Masui
D475,360 S * 6/2003 Yoneda et al. D14/168
D483,349 S 12/2003 Murakami
D491,167 S 6/2004 Yokoyama
D504,415 S * 4/2005 Lum D14/216

* cited by examiner

Primary Examiner—Nanda Bondade

(74) *Attorney, Agent, or Firm*—Rader, Fishman & Grauer,
PLLC

(57) **CLAIM**

The ornamental design for a speaker box, as shown.

DESCRIPTION

FIG. 1 is a perspective view of a speaker box showing my new design;

FIG. 2 is a front elevational view thereof;

FIG. 3 is a rear elevational view thereof;

FIG. 4 is a left side elevational view thereof;

FIG. 5 is a right side elevational view thereof;

FIG. 6 is a top plan view thereof; and,

FIG. 7 is a bottom plan view thereof.

1 Claim, 7 Drawing Sheets

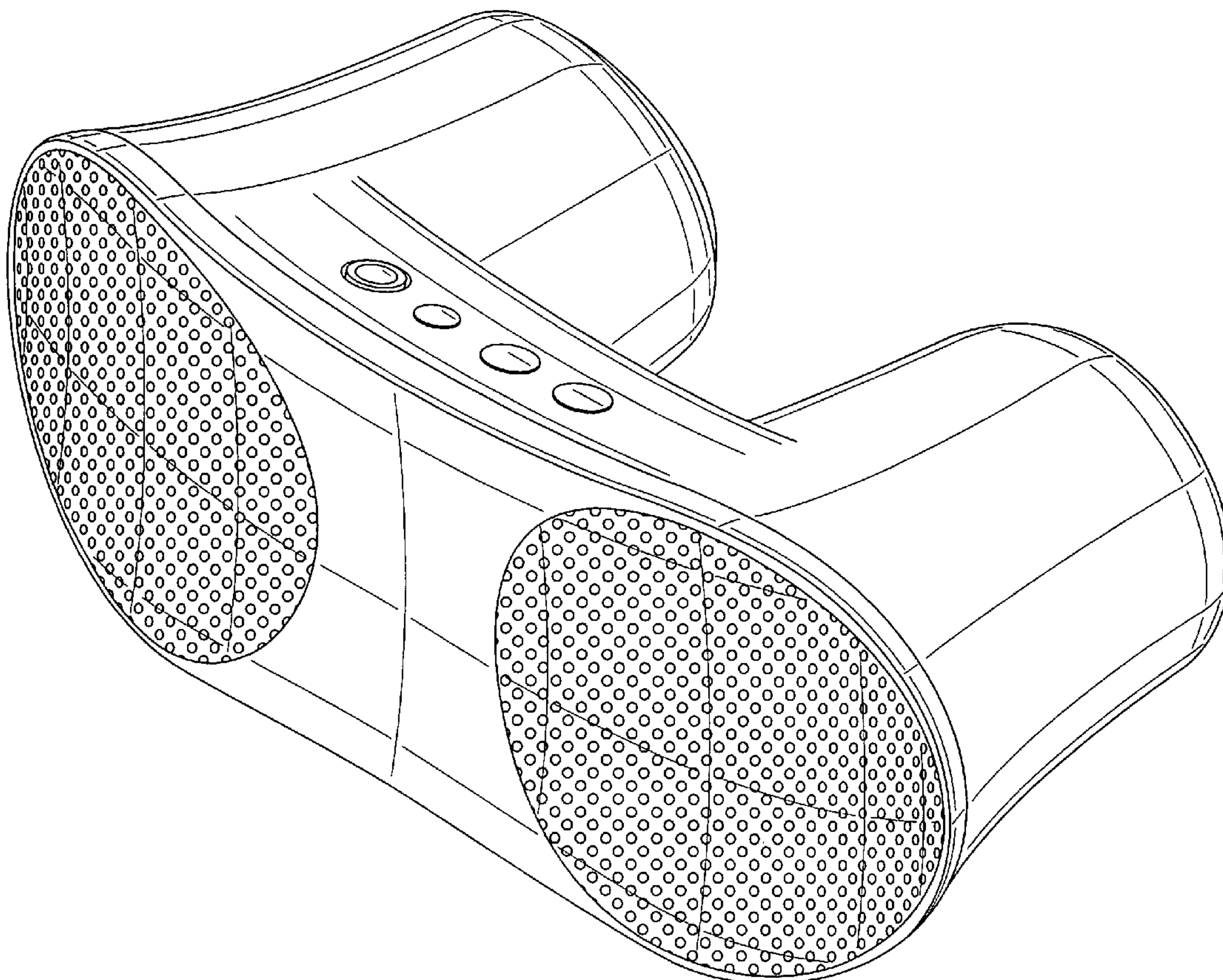

Fig.1

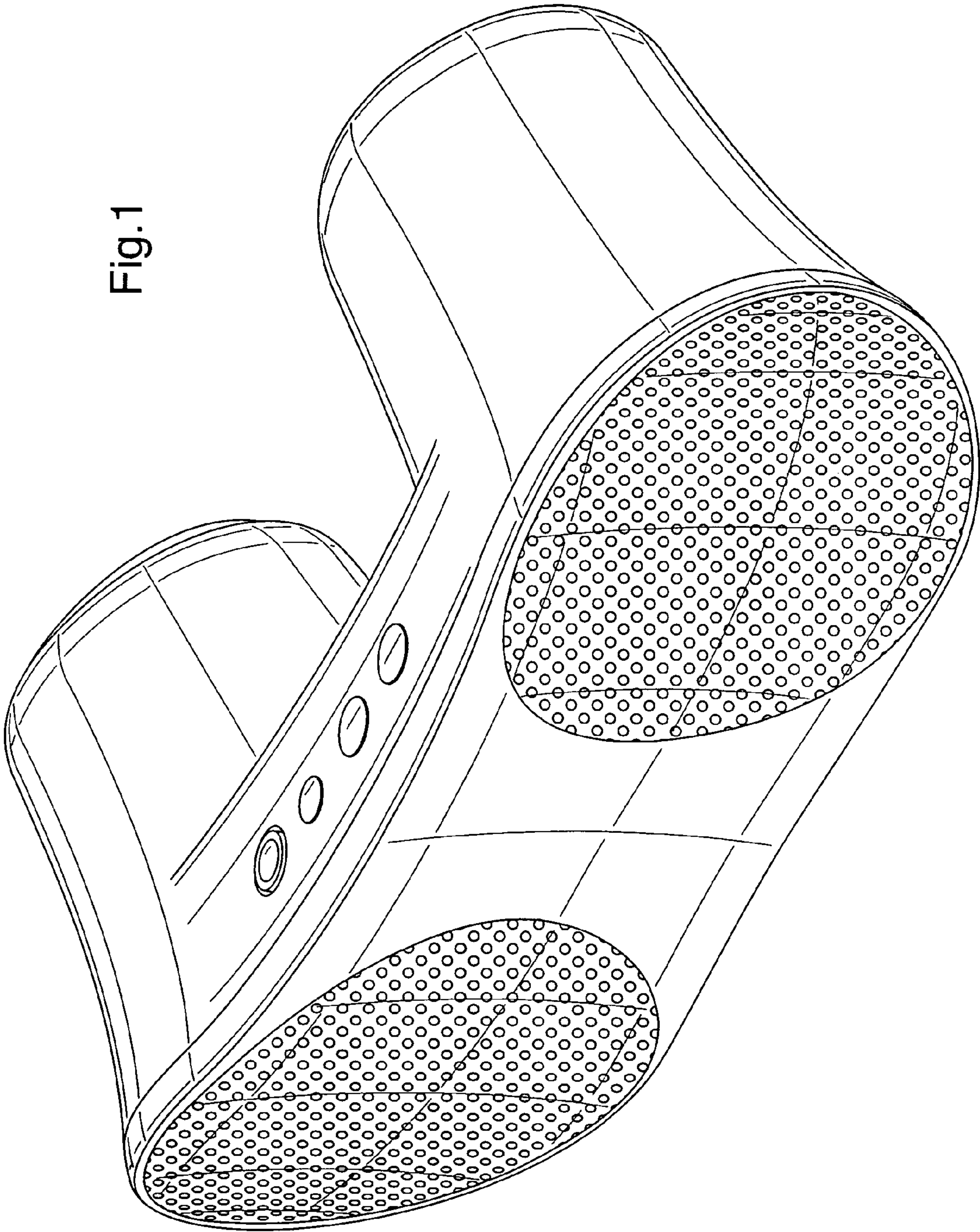

Fig.2

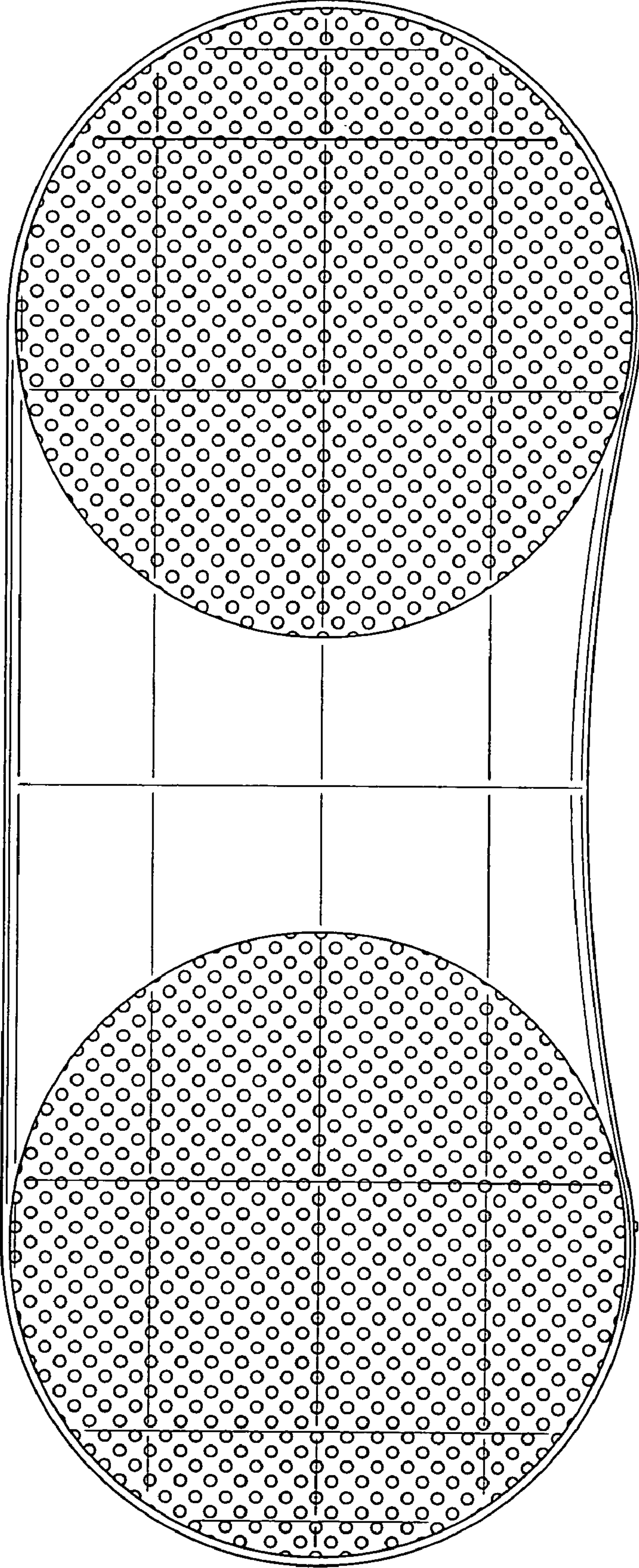

Fig.3

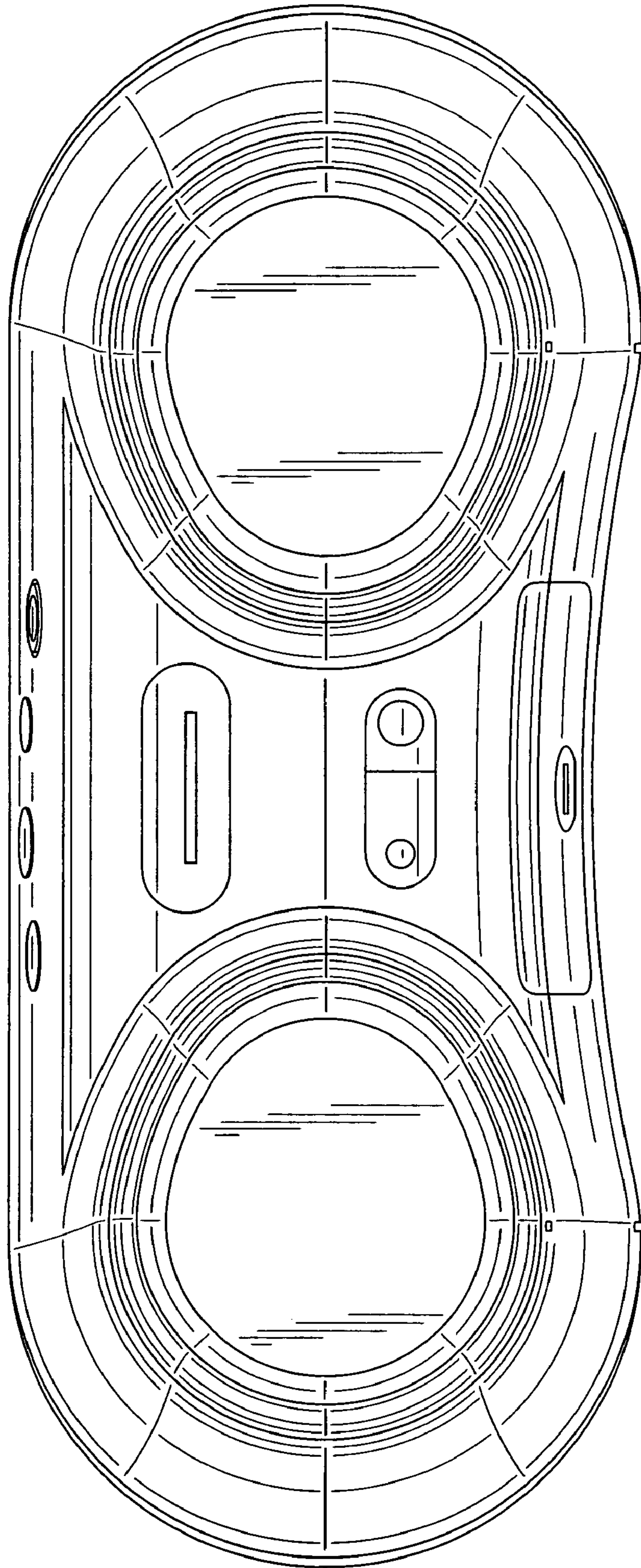

Fig.4

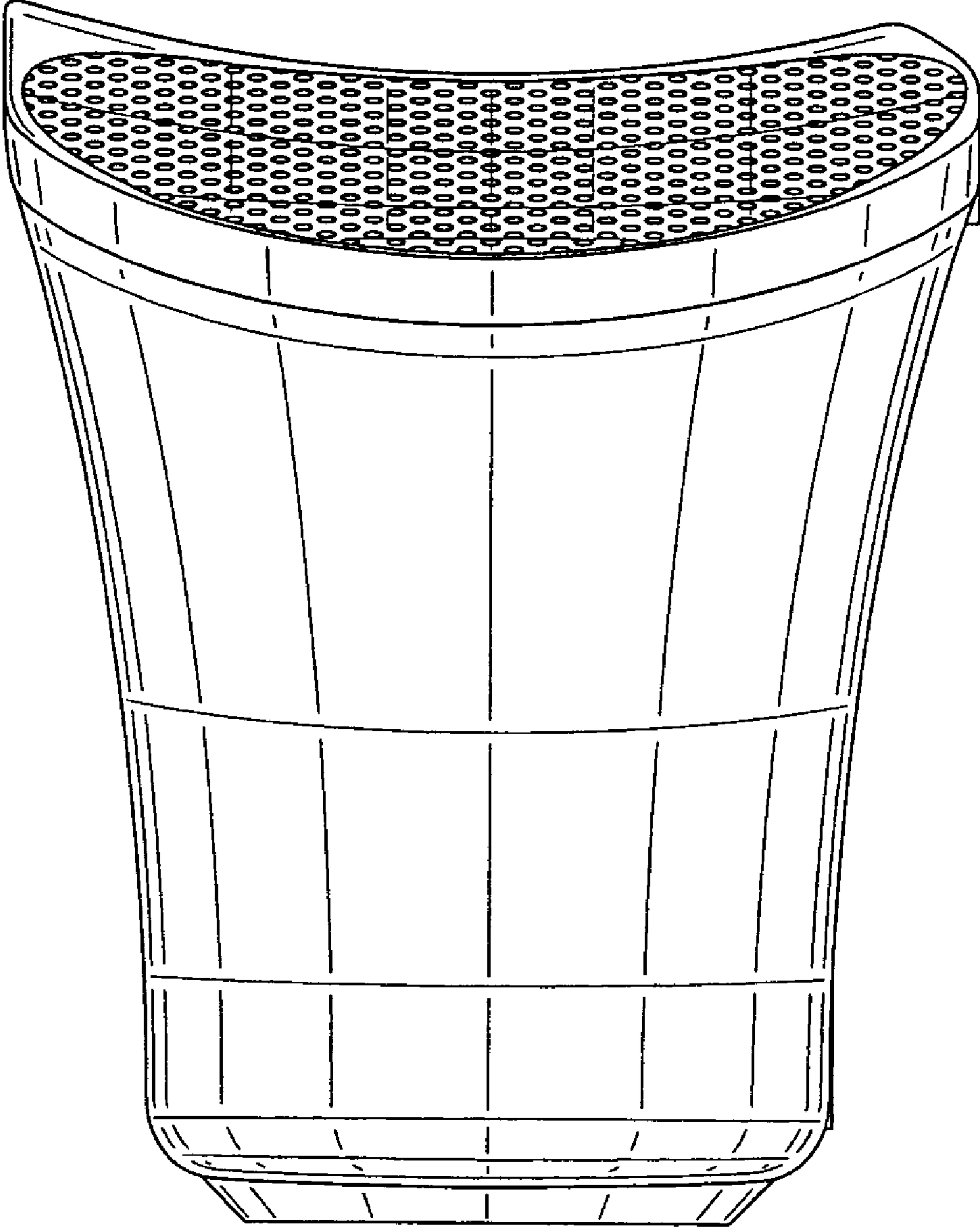

Fig. 5

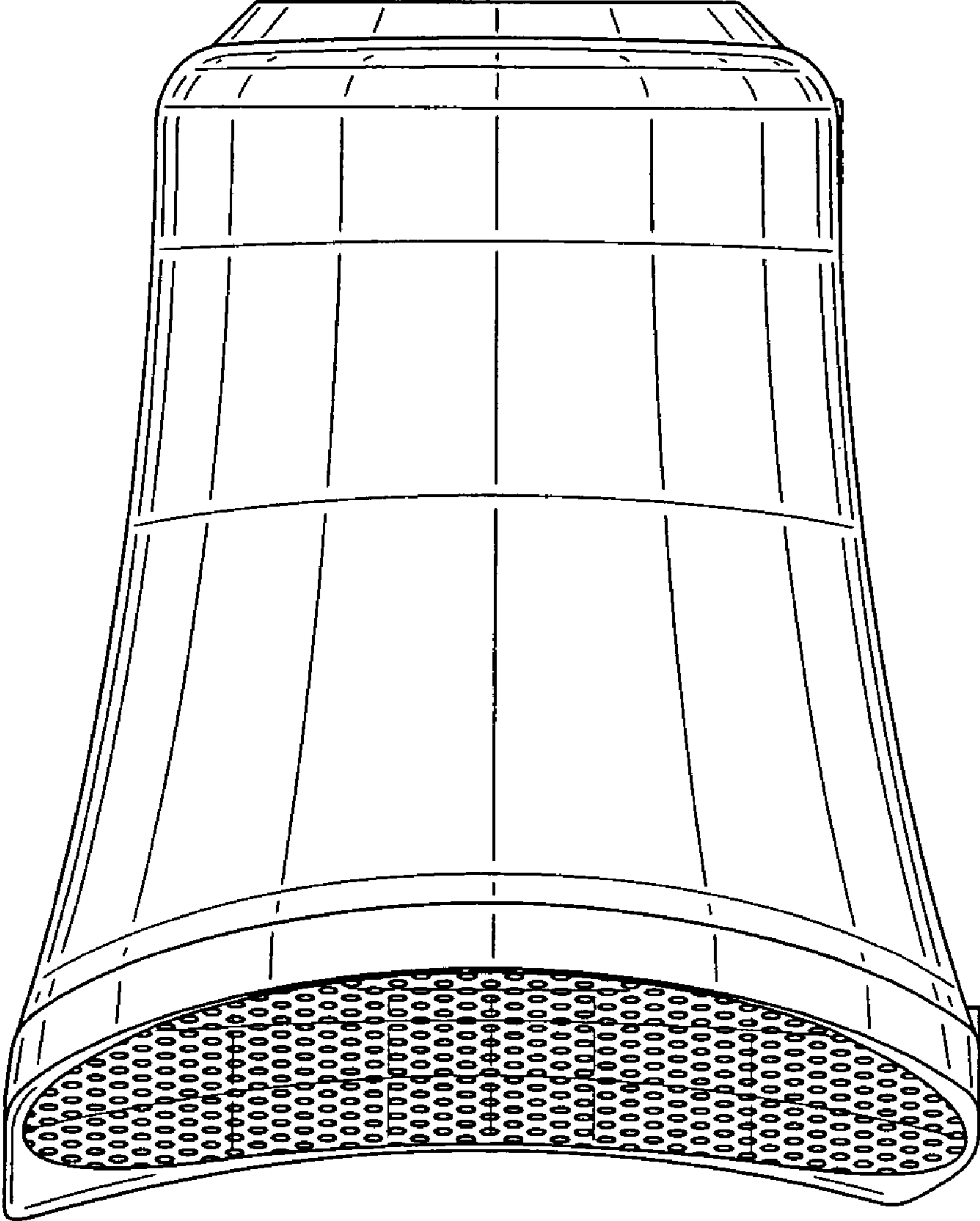

Fig.6

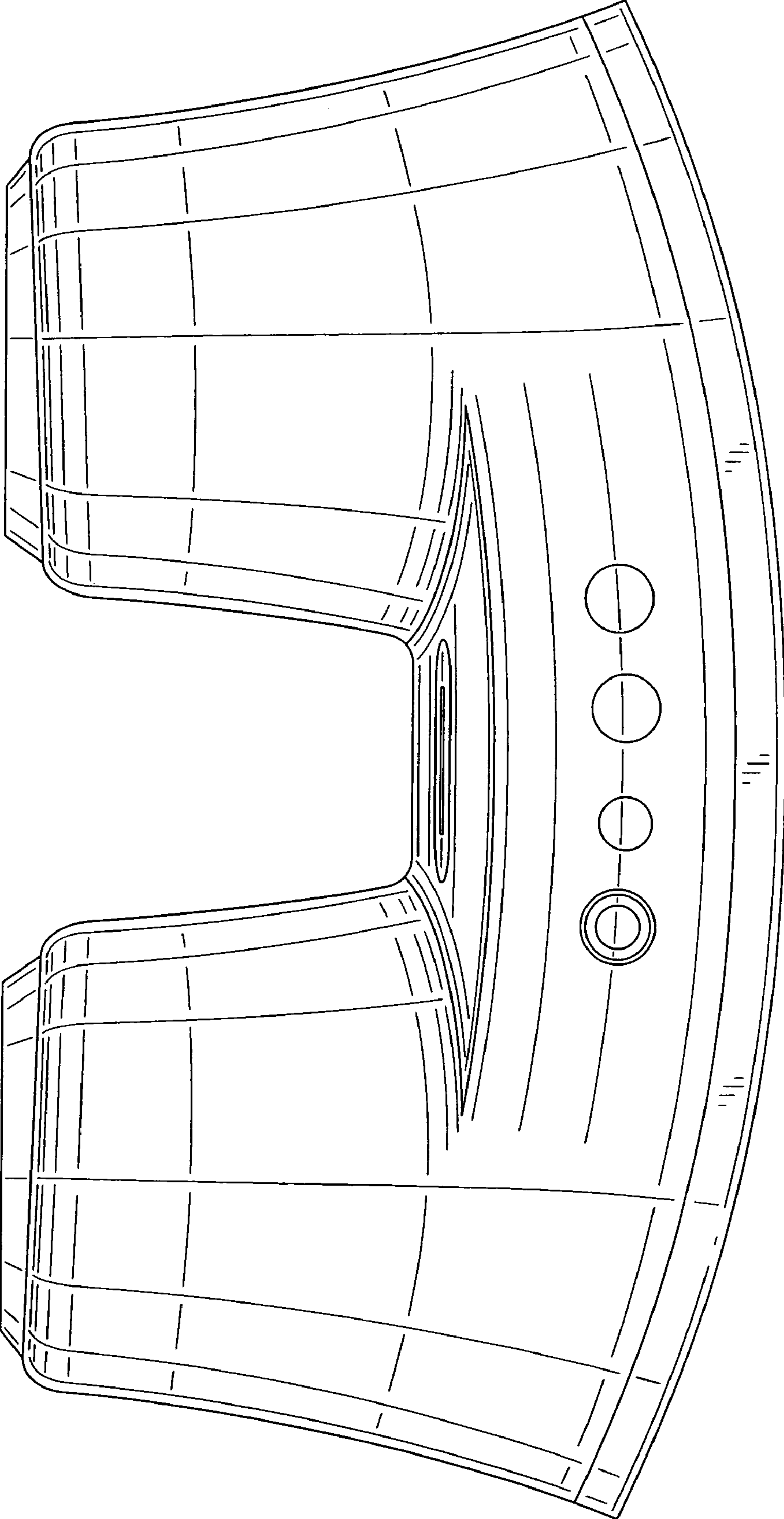

Fig.7

