



US00D585423S

(12) **United States Design Patent**  
**Yoneda**

(10) **Patent No.:** **US D585,423 S**  
(45) **Date of Patent:** **\*\* Jan. 27, 2009**

(54) **SPEAKER BOX**

(75) Inventor: **Naofumi Yoneda**, Tokyo (JP)

(73) Assignee: **Sony Corporation**, Tokyo (JP)

(\*\*) Term: **14 Years**

(21) Appl. No.: **29/271,147**

(22) Filed: **Jan. 11, 2007**

(30) **Foreign Application Priority Data**

Sep. 11, 2006 (JP) ..... D2006-024192

(51) **LOC (9) Cl.** ..... **14-01**

(52) **U.S. Cl.** ..... **D14/216**

(58) **Field of Classification Search** ..... D14/204,  
D14/207, 210–216, 170–172; 181/143–144,  
181/147–148, 150–153, 157, 198–199; 381/300–303,  
381/306, 332–333, 336, 345, 361–364, 386–388  
See application file for complete search history.

(56) **References Cited**

**U.S. PATENT DOCUMENTS**

4,942,939 A \* 7/1990 Harrison ..... 181/156  
D359,285 S \* 6/1995 Niblett ..... D14/170  
D437,843 S 2/2001 Masui  
D475,360 S \* 6/2003 Yoneda et al. .... D14/168

D475,361 S \* 6/2003 Yoneda et al. .... D14/168  
D483,349 S 12/2003 Murakami  
D491,167 S 6/2004 Yokoyama  
D504,415 S \* 4/2005 Lum ..... D14/216

\* cited by examiner

*Primary Examiner*—Nanda Bondade

(74) *Attorney, Agent, or Firm*—Rader, Fishman & Grauer,  
PLLC

(57) **CLAIM**

The ornamental design for a speaker box, as shown and described.

**DESCRIPTION**

FIG. 1 is a perspective view of a speaker box showing my new design;

FIG. 2 is a front elevational view thereof;

FIG. 3 is a rear elevational view thereof;

FIG. 4 is a left side elevational view thereof;

FIG. 5 is a right side elevational view thereof;

FIG. 6 is a top plan view thereof; and,

FIG. 7 is a bottom plan view thereof.

Portions shown as broken lines are for illustrative purpose only and form no part of the claimed design.

**1 Claim, 7 Drawing Sheets**

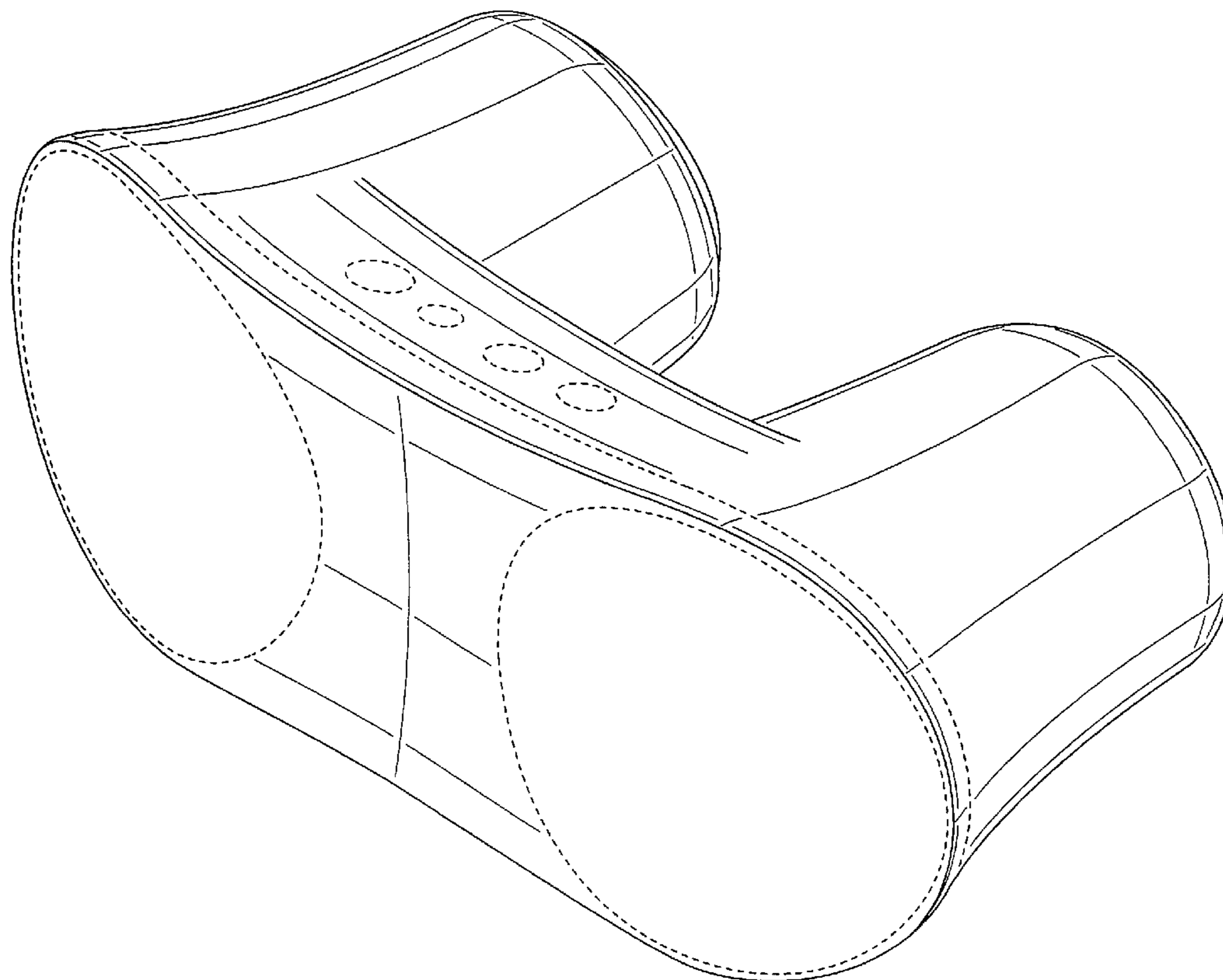

Fig.1

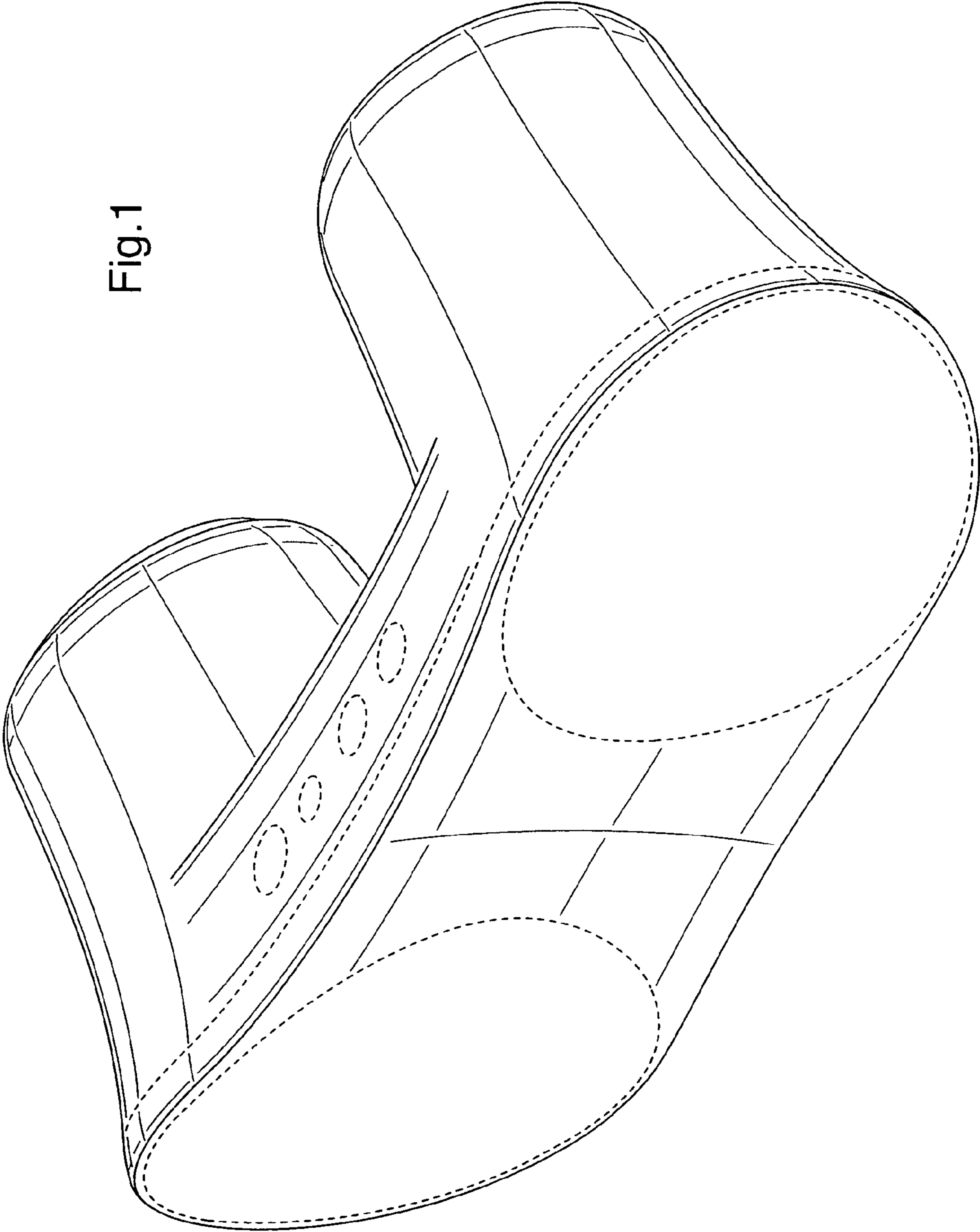

Fig.2

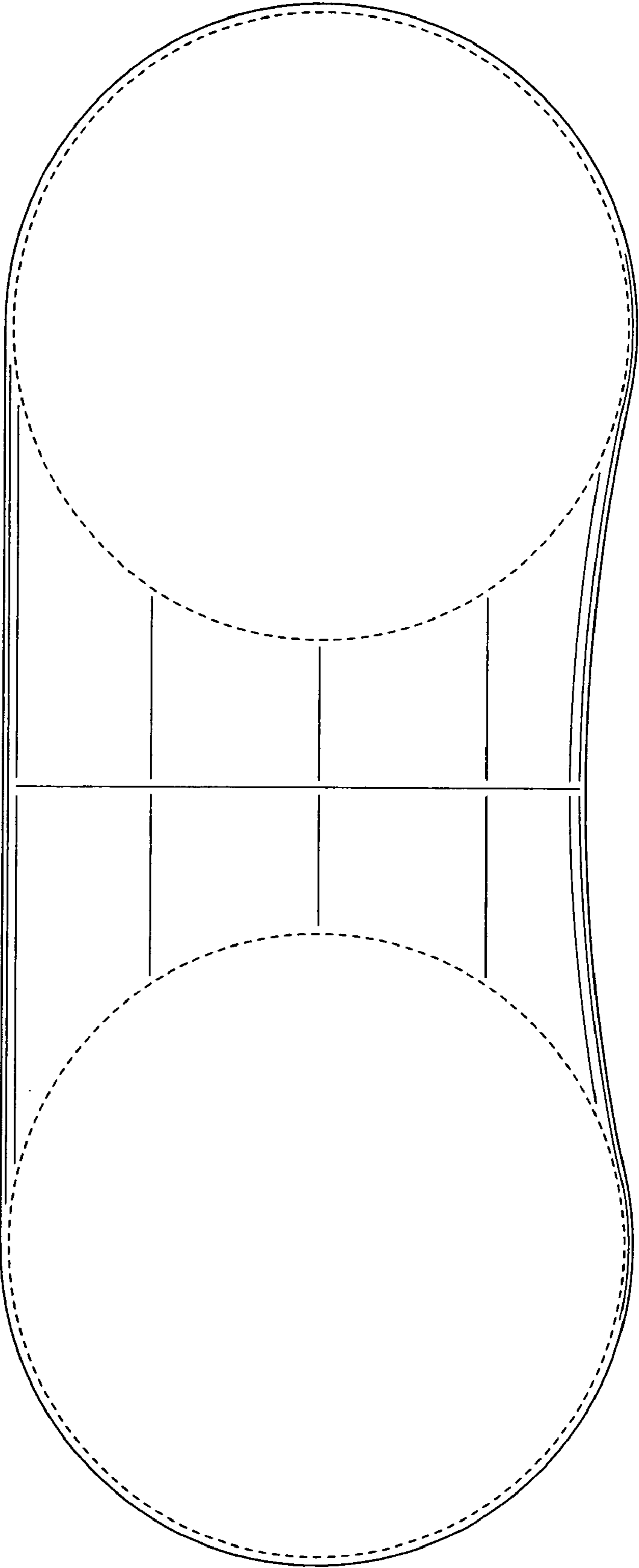

Fig.3

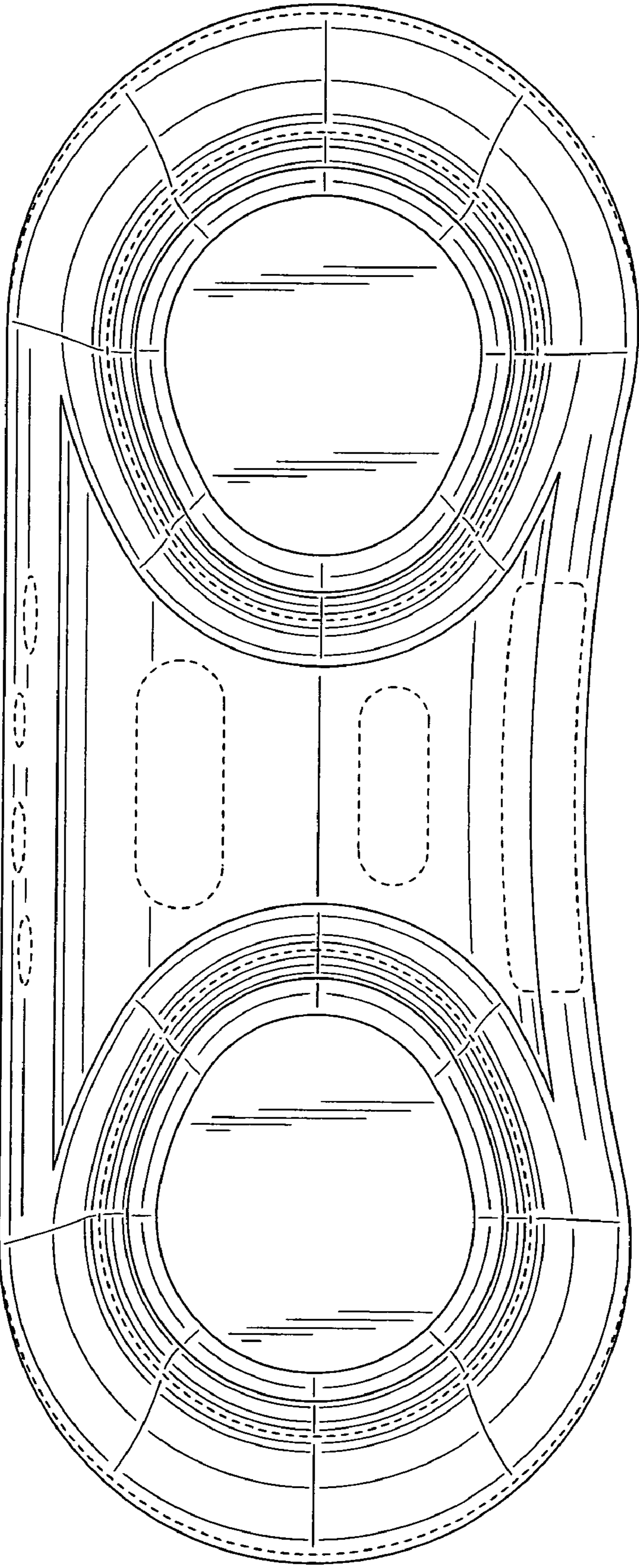



Fig.4

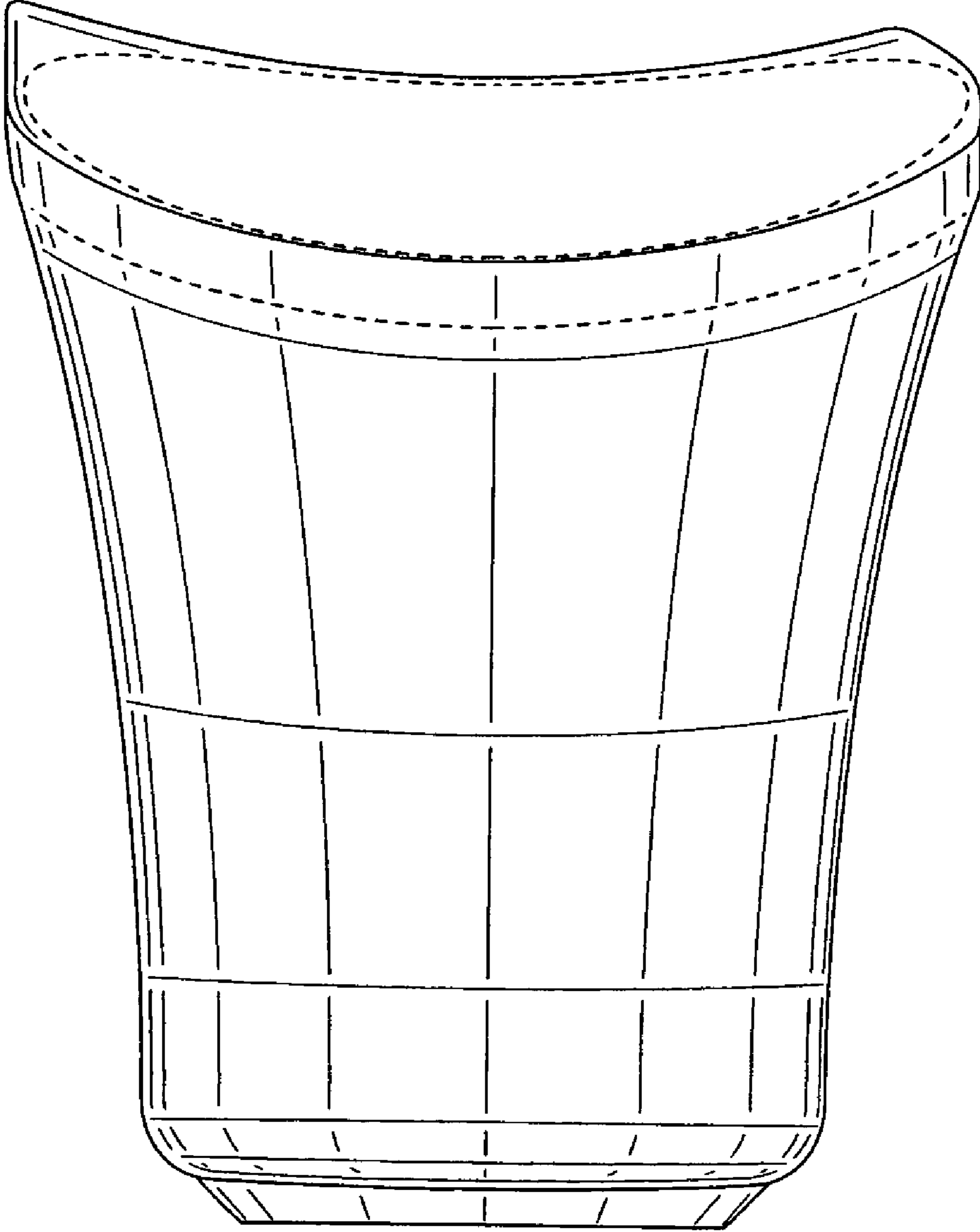

Fig. 5

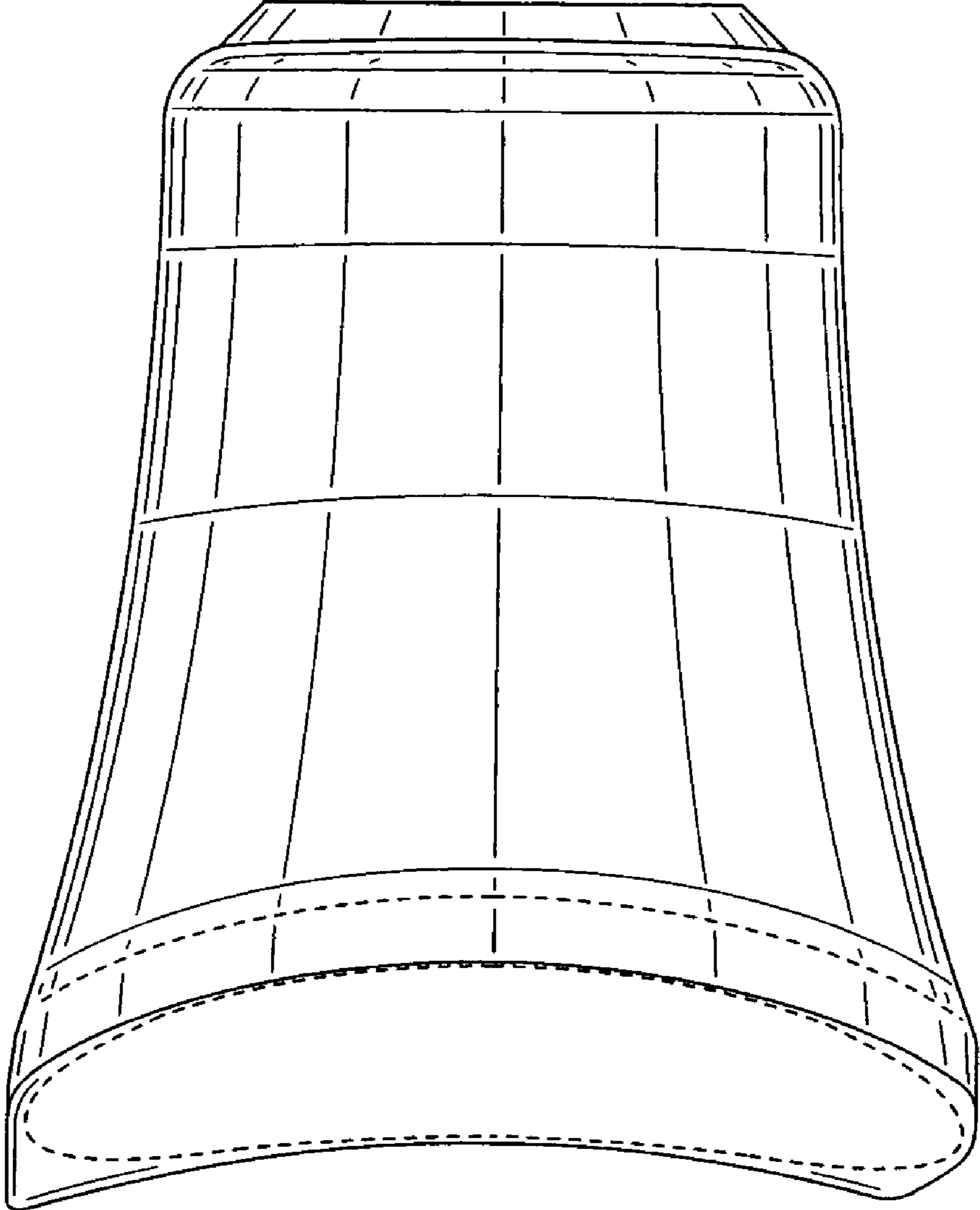

Fig.6

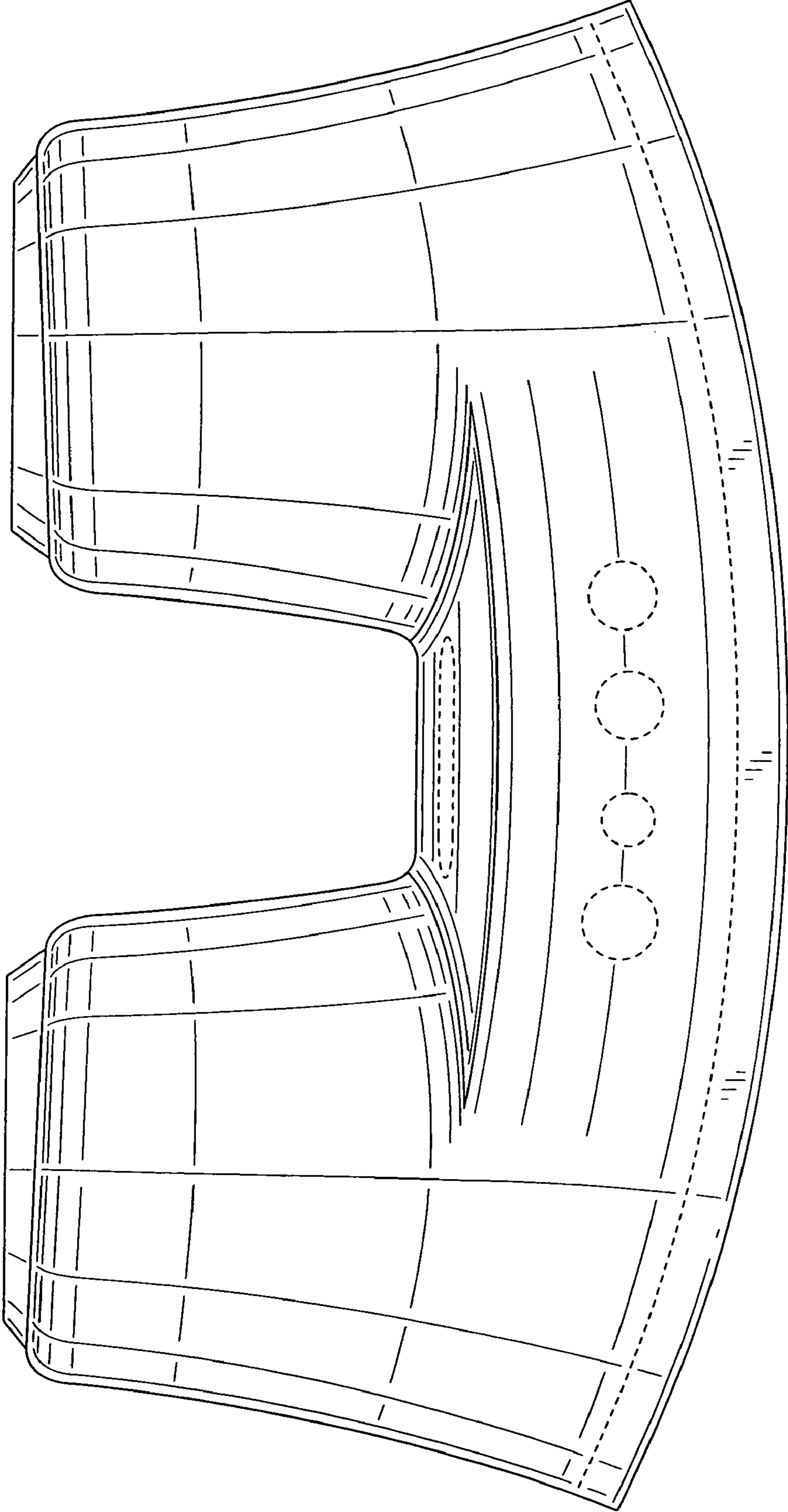

Fig. 7

