



US00D585417S

(12) **United States Design Patent**
Mitchell

(10) **Patent No.:** **US D585,417 S**
(45) **Date of Patent:** **** Jan. 27, 2009**

(54) **HANDSET**

(75) Inventor: **Edward Mitchell**, Thousand Oaks, CA
(US)

(73) Assignee: **Nokia Corporation**, Espoo (FI)

(**) Term: **14 Years**

(21) Appl. No.: **29/305,526**

(22) Filed: **Mar. 21, 2008**

(51) **LOC (9) Cl.** **14-03**

(52) **U.S. Cl.** **D14/138 AB**

(58) **Field of Classification Search** D14/138 AB,
D14/138 AA, 496, 341–347, 247, 455–456,
D14/218; 455/575.3, 575.1

See application file for complete search history.

(56) **References Cited**

U.S. PATENT DOCUMENTS

D496,016 S *	9/2004	Hoo	D14/138 AB
D507,562 S *	7/2005	Kim	D14/247
D508,035 S *	8/2005	Kim et al.	D14/138 AB
D537,059 S *	2/2007	Hwang	D14/138 AB
D542,770 S *	5/2007	Bower	D14/138 AB
D543,173 S *	5/2007	Park et al.	D14/138 AB
D544,474 S *	6/2007	Kim et al.	D14/247
D545,796 S *	7/2007	Kim et al.	D14/138 AB
D551,642 S *	9/2007	Kim et al.	D14/138 AB
D553,110 S *	10/2007	Park et al.	D14/138 AB
D558,167 S *	12/2007	Jung et al.	D14/138 AB
D559,214 S *	1/2008	Salmi	D14/138 AB
D560,186 S *	1/2008	Kim et al.	D14/138 AB
D560,189 S *	1/2008	Kim et al.	D14/138 AB
D560,643 S *	1/2008	Kim et al.	D14/138 AB
D561,149 S *	2/2008	Park et al.	D14/138 AB
D563,376 S *	3/2008	Arnholt et al.	D14/138 AB
D565,010 S *	3/2008	Baik et al.	D14/138 AB
D565,038 S *	3/2008	Lee et al.	D14/247
D568,850 S *	5/2008	Lyles	D14/138 AB
D573,574 S *	7/2008	Suk et al.	D14/138
D573,968 S *	7/2008	Chen et al.	D14/138
D577,701 S *	9/2008	Oh et al.	D14/138 AB

D577,716 S *	9/2008	Hering et al.	D14/247
D578,499 S *	10/2008	Park et al.	D14/138 AB
D578,504 S *	10/2008	Stillerman	D14/138 AB
D578,981 S *	10/2008	Park et al.	D14/138 R
2006/0146030 A1 *	7/2006	Kim	345/169
2006/0160583 A1 *	7/2006	Ryu	455/575.3

OTHER PUBLICATIONS

Nokia 6650 T-Mobile telephone, announced Mar. 2008, [online], [site visited Nov. 4, 2008]. Available from Internet ,<URL: <http://www.gsmarena.com>>.*

(Continued)

Primary Examiner—Jeffrey D Asch

(74) *Attorney, Agent, or Firm*—Banner & Witcoff, Ltd.

(57) **CLAIM**

The ornamental design for a handset, as shown and described.

DESCRIPTION

FIG. 1 is a front perspective view of a handset showing my new design in an open, in-use position;

FIG. 2 is a rear perspective view thereof;

FIG. 3 is a front view thereof;

FIG. 4 is a right side view thereof;

FIG. 5 is a left side view thereof;

FIG. 6 is a top view thereof;

FIG. 7 is a bottom view thereof; and,

FIG. 8 is a rear view thereof.

The broken lines showing various environmental structures of the handset in FIGS. 1–8 are for illustrative purposes only and form no part of the claimed design.

The broken lines throughout the views that are immediately adjacent to the shaded areas, and define unshaded regions, represent the bounds of the claimed design, while all other broken lines are directed to environment and are for illustrative purposes only; the broken lines form no part of the claimed design.

1 Claim, 6 Drawing Sheets

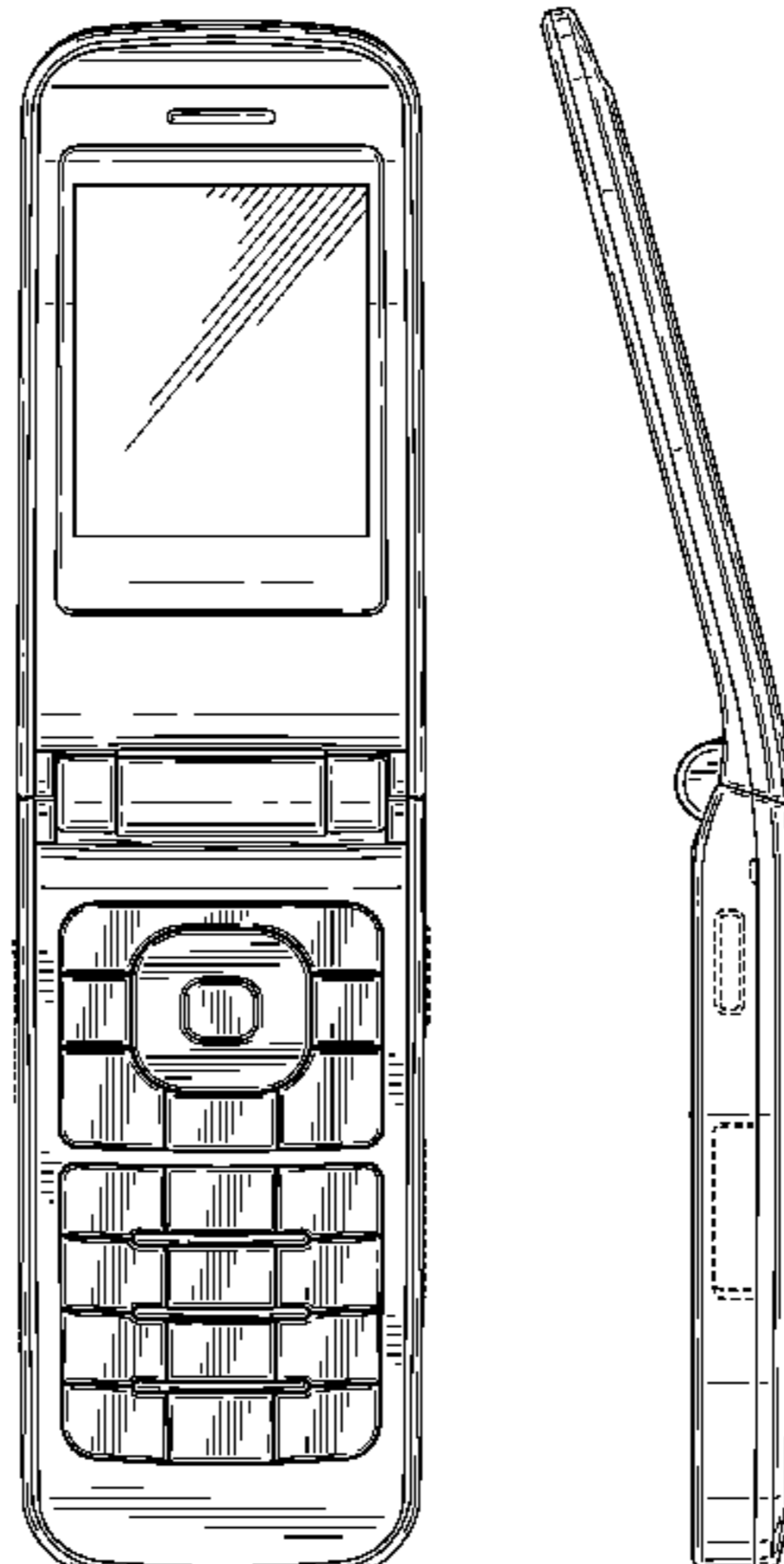

OTHER PUBLICATIONS

LG MG295 telephone, announced Jan. 2008, [online], [site visited Nov. 4, 2008]. Available from Internet ,<URL: <http://www.gsmarena.com>>.*

LG KP210 telephone, announced Feb. 2008, [online], [site visited Nov. 4, 2008]. Available from Internet ,<URL: <http://www.gsmarena.com>>.*

LG CU500 telephone, announced Jul. 2006, [online], [site visited Nov. 4, 2008]. Available from Internet ,<URL: <http://www.gsmarena.com>>.*

LG KU730 telephone, announced Feb. 2006, [online], [site visited Nov. 4, 2008]. Available from Internet ,<URL: <http://www.gsmarena.com>>.*

Pantech PG-6200 telephone, announced Feb. 2006, [online], [site visited Nov. 4, 2008]. Available from Internet ,<URL: <http://www.gsmarena.com>>.*

Nokia Model # 6101, Nokia Corporation, 2 color sheets of photographs, disclosed on or about Feb. 2005.

* cited by examiner

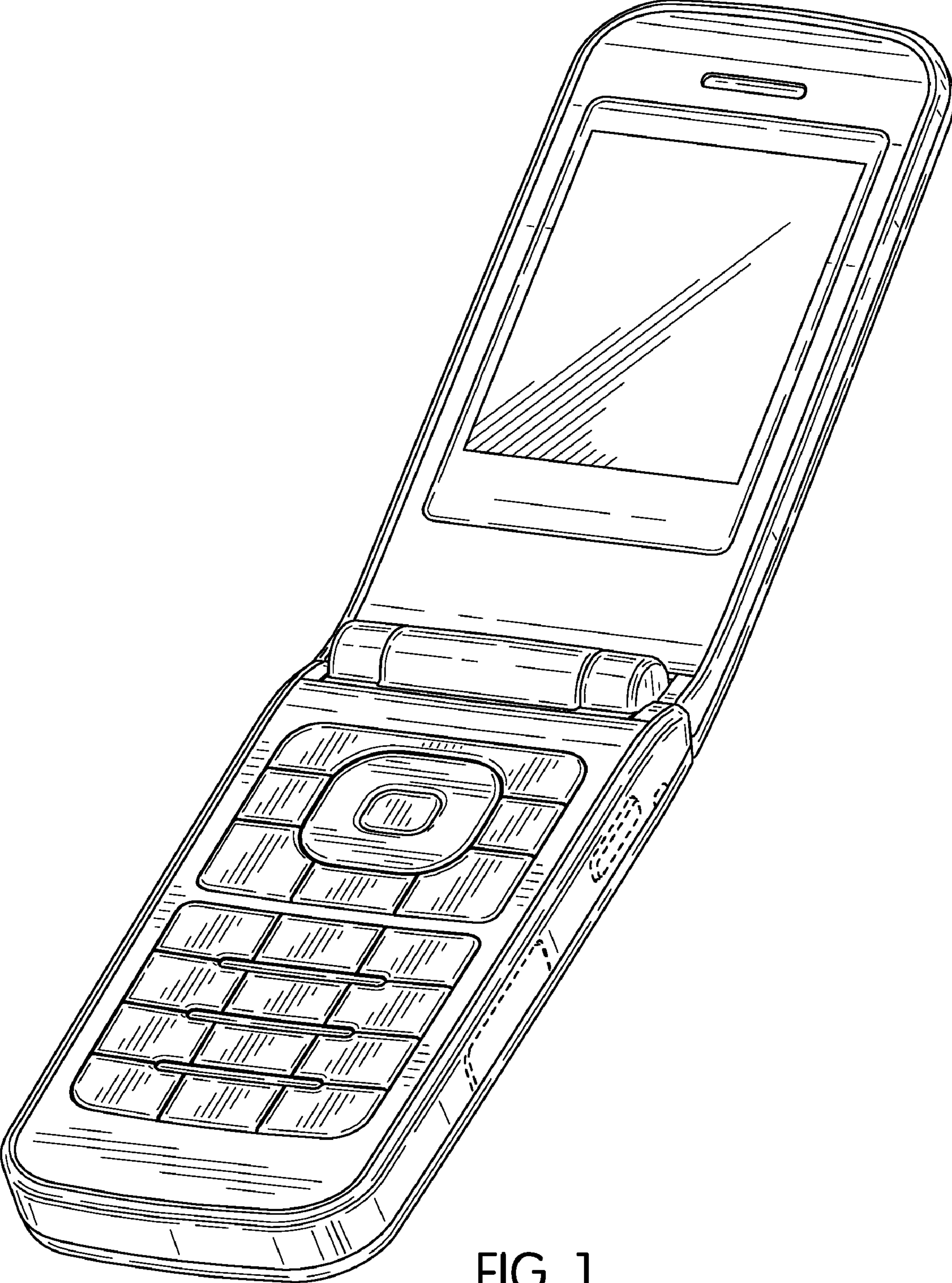

FIG. 1

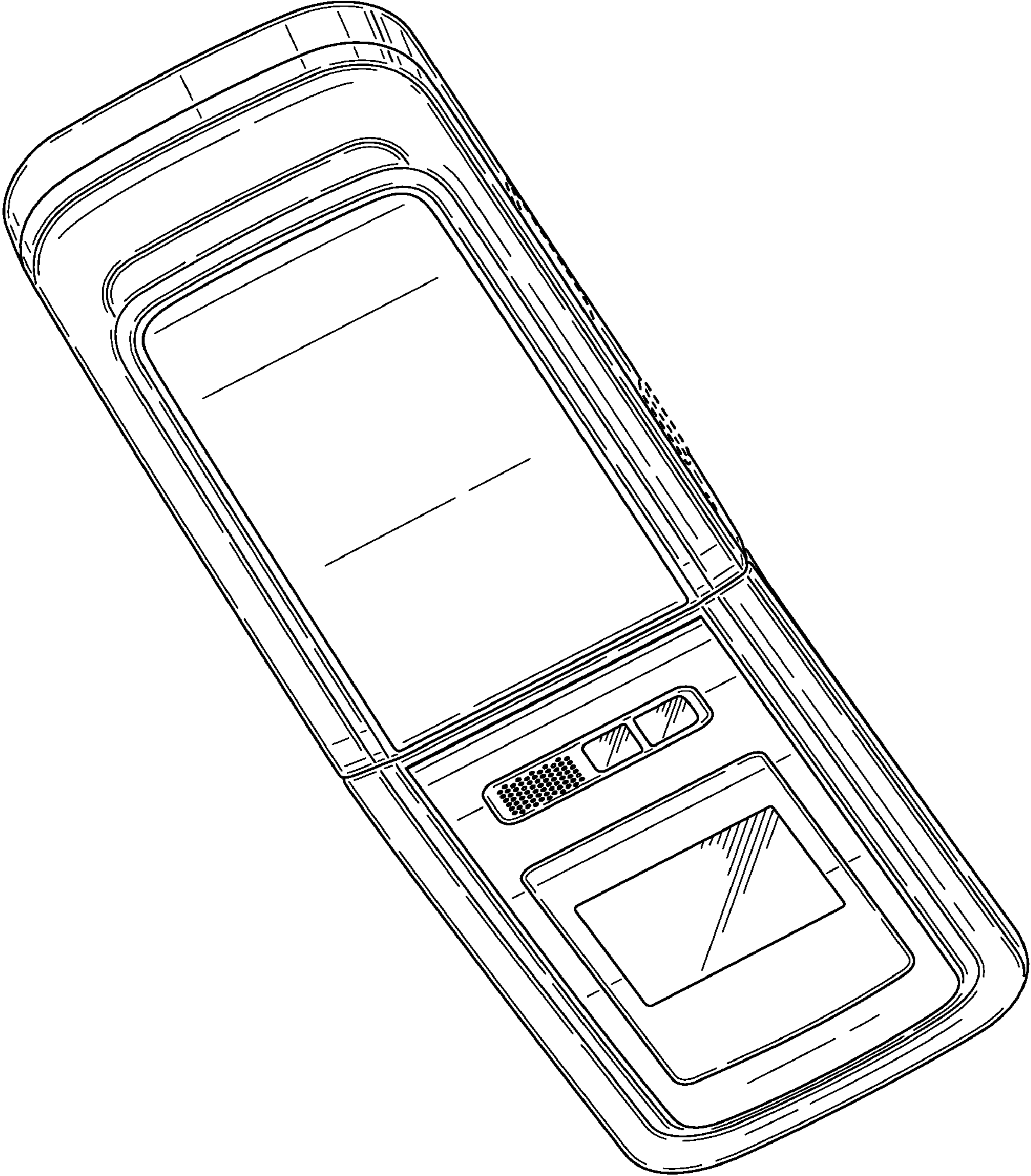

FIG. 2

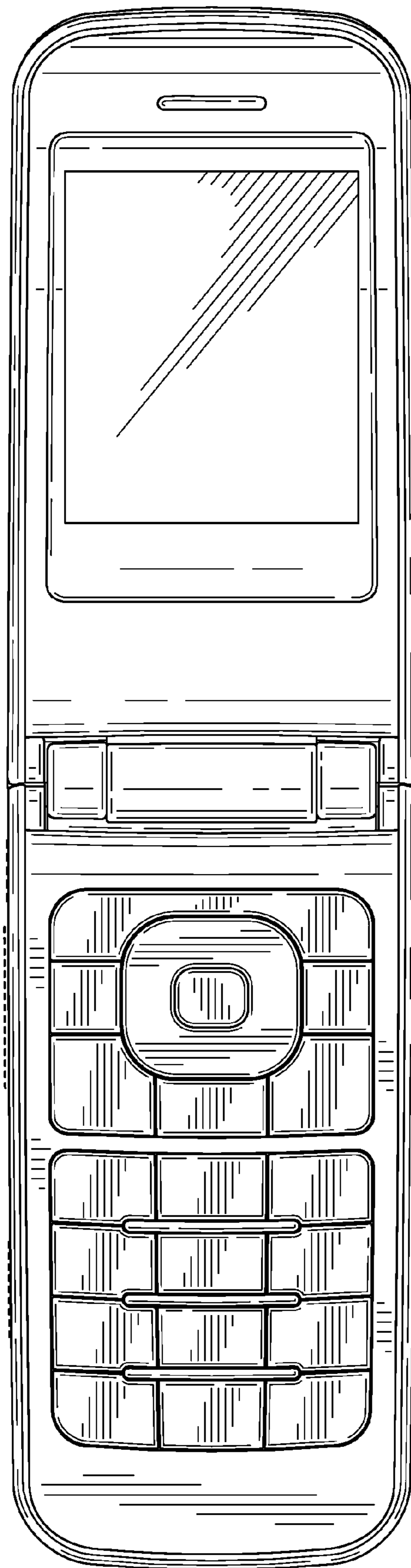

FIG. 3

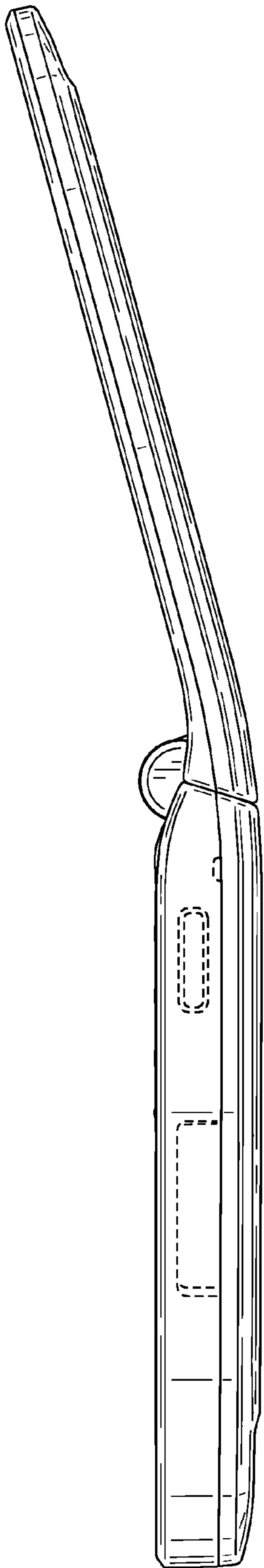

FIG. 4

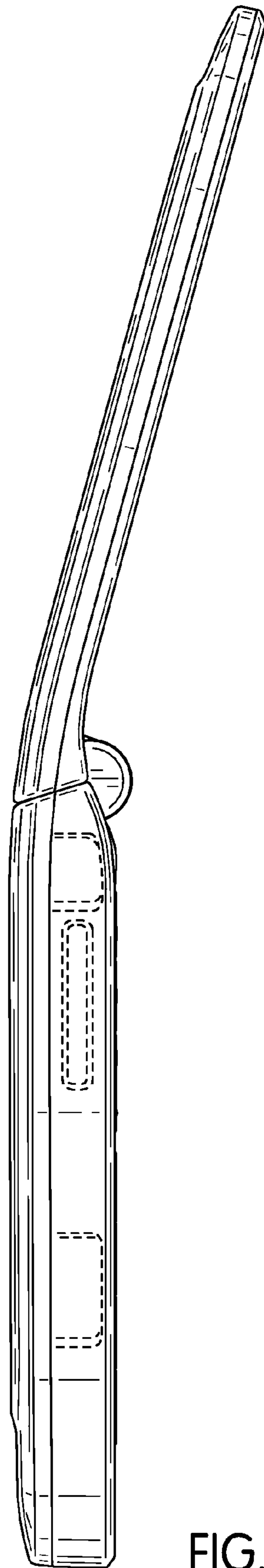

FIG. 5

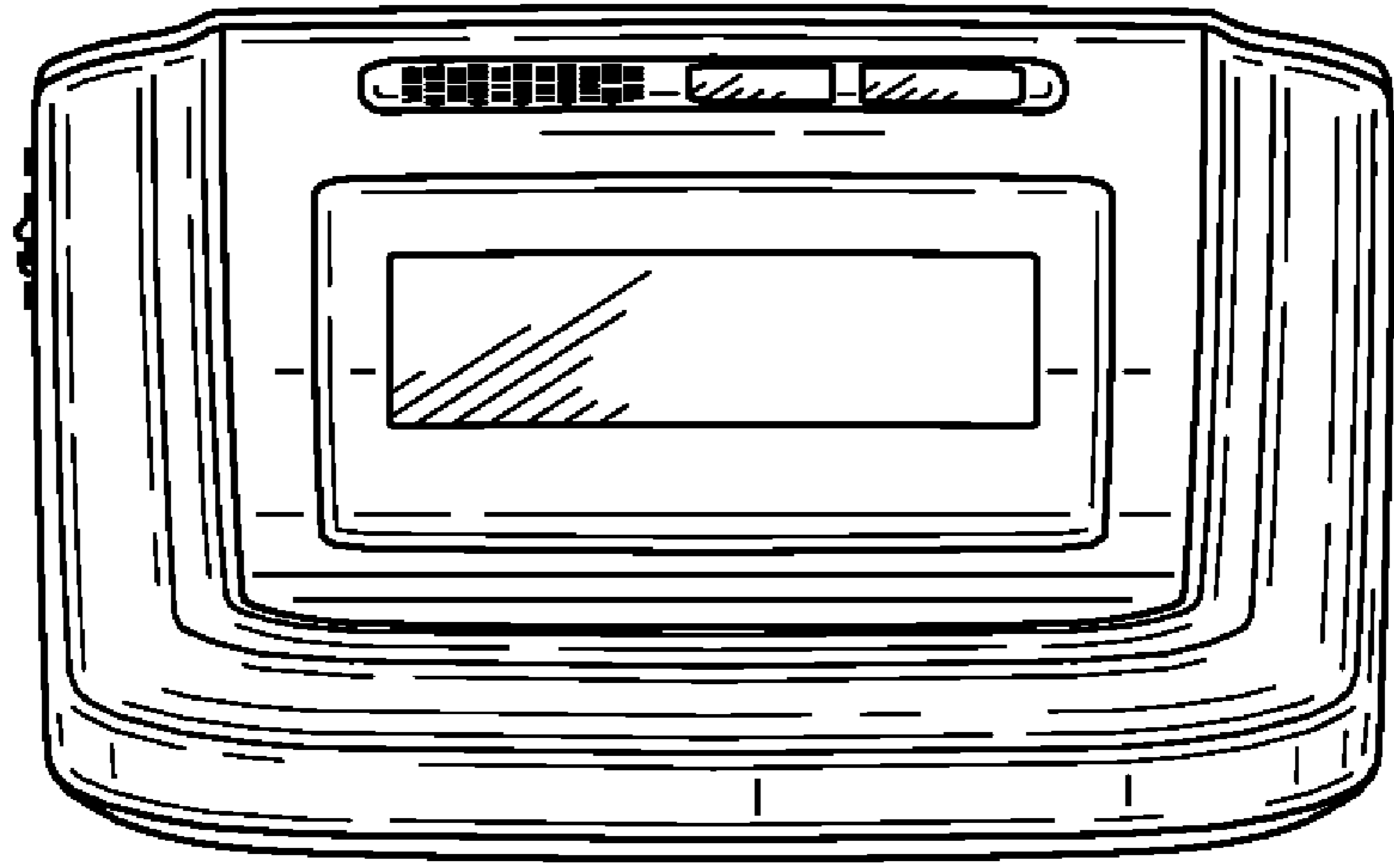

FIG. 6

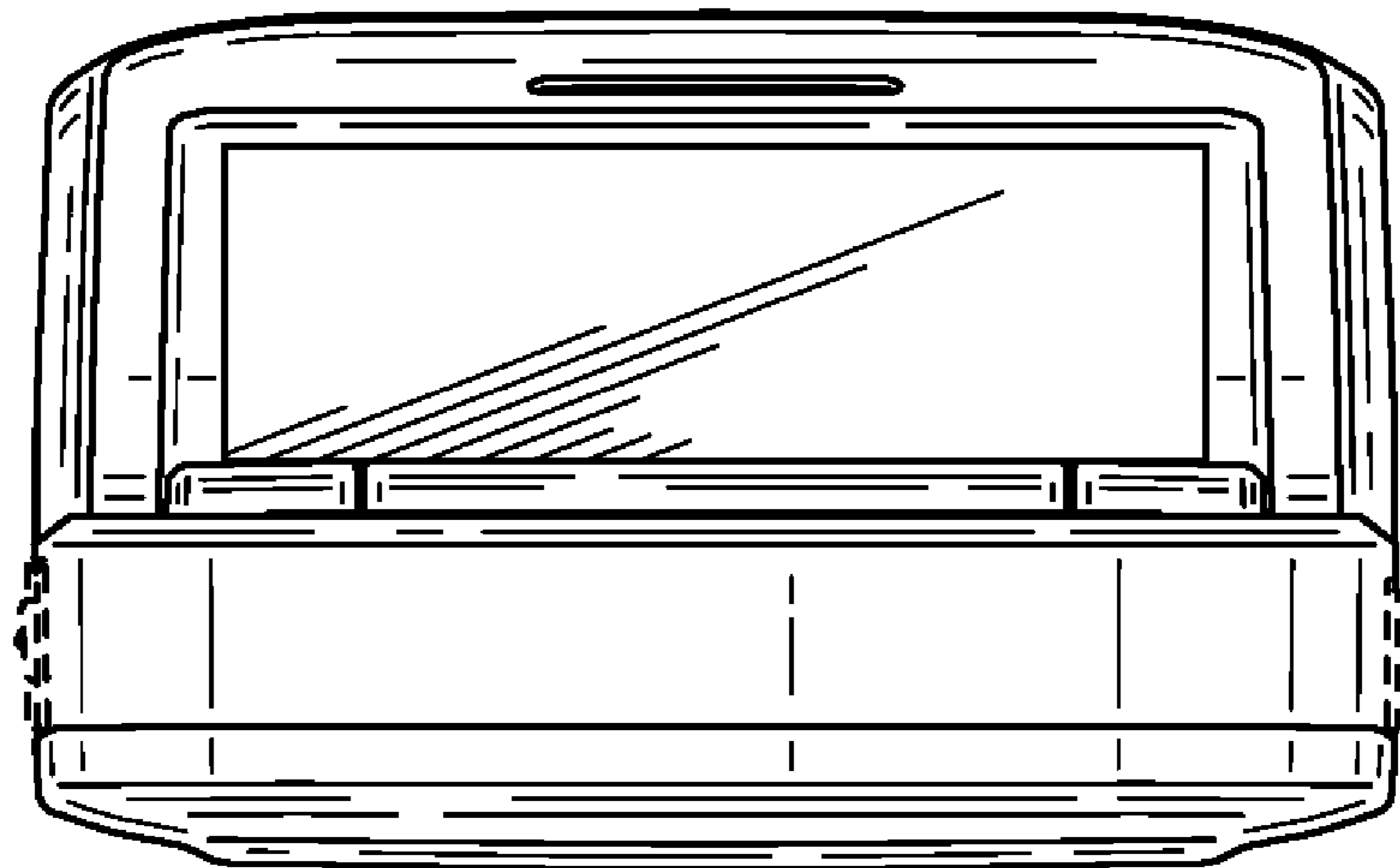

FIG. 7

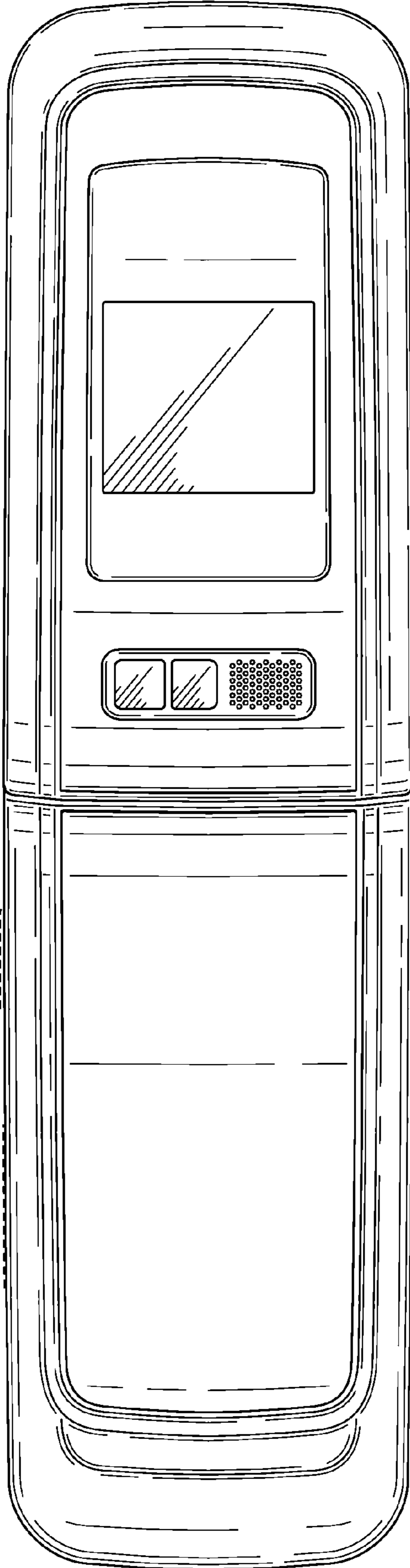

FIG. 8