



US00D585384S

(12) **United States Design Patent**  
**Andre et al.**

(10) **Patent No.:** **US D585,384 S**  
(45) **Date of Patent:** **\*\* Jan. 27, 2009**

(54) **CABLE**

(75) Inventors: **Bartley K. Andre**, Menlo Park, CA (US); **Daniel J. Coster**, San Francisco, CA (US); **Daniele De Iuliis**, San Francisco, CA (US); **Richard P. Howarth**, San Francisco, CA (US); **Jonathan P. Ive**, San Francisco, CA (US); **Duncan Robert Kerr**, San Francisco, CA (US); **Shin Nishibori**, San Francisco, CA (US); **Matthew Dean Rohrbach**, San Francisco, CA (US); **Peter Russell-Clarke**, San Francisco, CA (US); **Douglas B. Satzger**, Menlo Park, CA (US); **Christopher J. Stringer**, Portola Valley, CA (US); **Eugene Antony Whang**, San Francisco, CA (US); **Rico Zorkendorfer**, San Francisco, CA (US)

(73) Assignee: **Apple Inc.**, Cupertino, CA (US)

(\*\*) Term: **14 Years**

(21) Appl. No.: **29/284,334**

(22) Filed: **Sep. 5, 2007**

(51) **LOC (9) Cl.** ..... **13-03**

(52) **U.S. Cl.** ..... **D13/154; D13/146; D13/153**

(58) **Field of Classification Search** ..... **D13/133, D13/146, 147, 154, 156; 439/447, 483, 606-610, 439/668, 669, 675, 676, 680, 687, 750**  
See application file for complete search history.

(56) **References Cited**

U.S. PATENT DOCUMENTS

5,117,479 A \* 5/1992 Erdman et al. .... 385/136

OTHER PUBLICATIONS

U.S. Appl. No. 29/270,882, filed Jan. 5, 2007.  
U.S. Appl. No. 29/270,886, filed Jan. 5, 2007.  
U.S. Appl. No. 29/281,458, filed Jun. 22, 2007.

*Primary Examiner*—Daniel D Bui  
*Assistant Examiner*—Thomas J Johannes  
(74) *Attorney, Agent, or Firm*—Sterne, Kessler, Goldstein & Fox P.L.L.C.

(57) **CLAIM**

The ornamental design for a cable, as shown and described.

**DESCRIPTION**

FIG. 1 is a perspective view of cables, showing our new design;

FIG. 2 is a top plan view thereof;

FIG. 3 is a bottom plan view thereof;

FIG. 4 is a side view of a portion, shown separately for clarity, of the cable of FIGS. 1 through 3;

FIG. 5 is a front view thereof;

FIG. 6 is a rear view thereof;

FIG. 7 is a rear perspective thereof;

FIG. 8 is a side view of another portion, shown separately for clarity, of the cable of FIGS. 1 through 3;

FIG. 9 is a rear view thereof;

FIG. 10 is a front view thereof;

FIG. 11 is a side view of another portion, shown separately for clarity, of the cable of FIGS. 1 through 3;

FIG. 12 is a rear view thereof; and,

FIG. 13 is a front view thereof.

The broken lines in the Figures, are for illustrative purposes only and form no part of the claimed design.

(Continued)

**1 Claim, 6 Drawing Sheets**

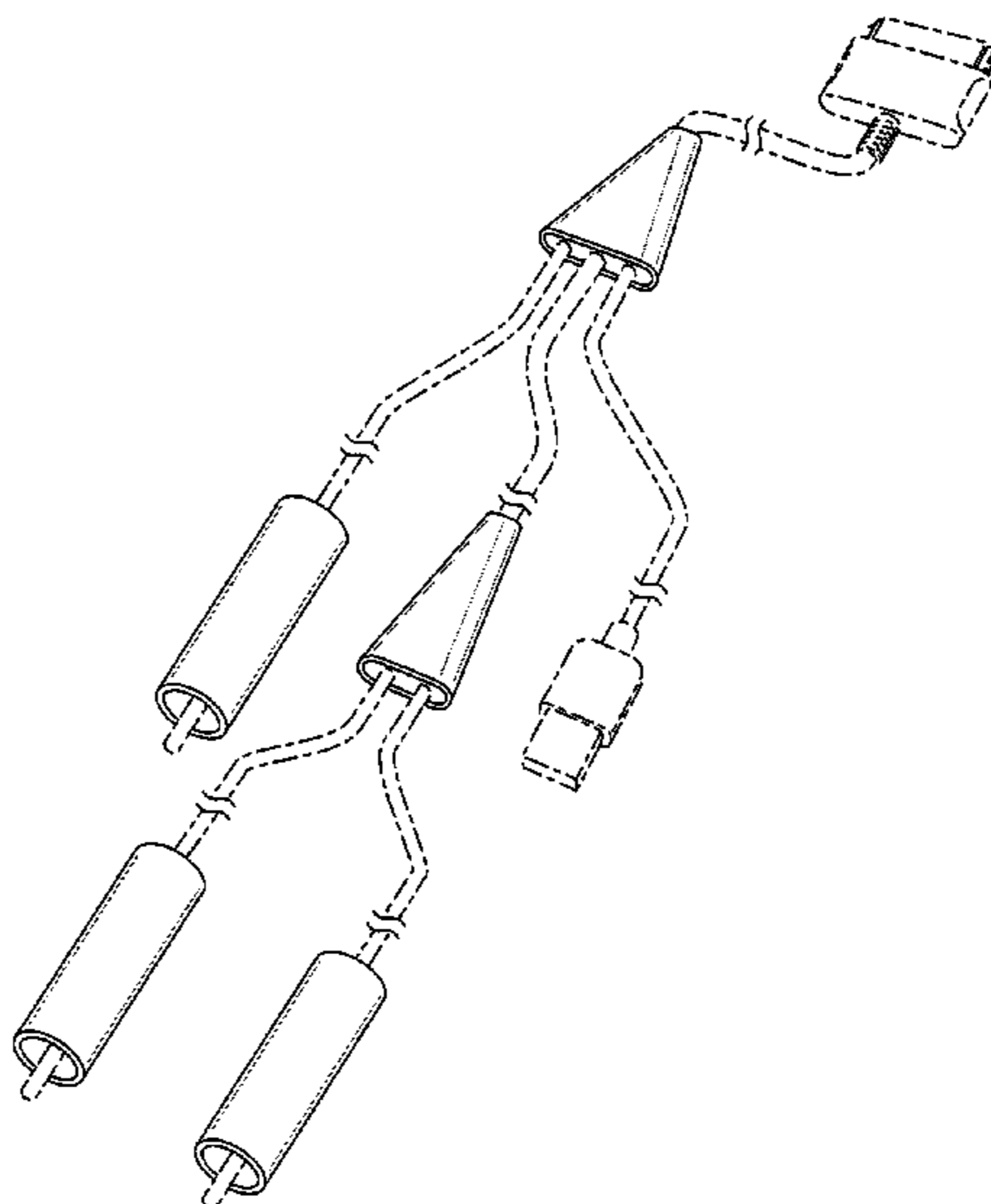

# US D585,384 S

Page 2

---

## U.S. PATENT DOCUMENTS

D332,098 S	12/1992	Riley et al.		D516,036 S *	2/2006	Nishio et al. ....	D13/147
D337,305 S	7/1993	Ross et al.		D525,199 S *	7/2006	Lin .....	D13/133
D356,293 S	3/1995	Riley et al.		D537,074 S	2/2007	Andre et al.	
5,547,399 A *	8/1996	Naghi et al. ....	439/623	D543,949 S *	6/2007	Victor .....	D13/154
D390,189 S *	2/1998	Stadler .....	D13/138.1	D553,089 S *	10/2007	Victor .....	D13/147
D405,049 S *	2/1999	Huang et al. ....	D13/133	D556,134 S *	11/2007	Lee et al. ....	D13/133
D407,369 S *	3/1999	Cormack .....	D13/133	D561,112 S *	2/2008	Victor .....	D13/154
D473,848 S *	4/2003	Zheng et al. ....	D13/147	D564,971 S *	3/2008	Victor .....	D13/153
D509,797 S *	9/2005	Milan .....	D13/133	D569,810 S *	5/2008	Victor .....	D13/154
D513,605 S *	1/2006	Lin .....	D13/133	D571,296 S *	6/2008	Kuo et al. ....	D13/147

\* cited by examiner

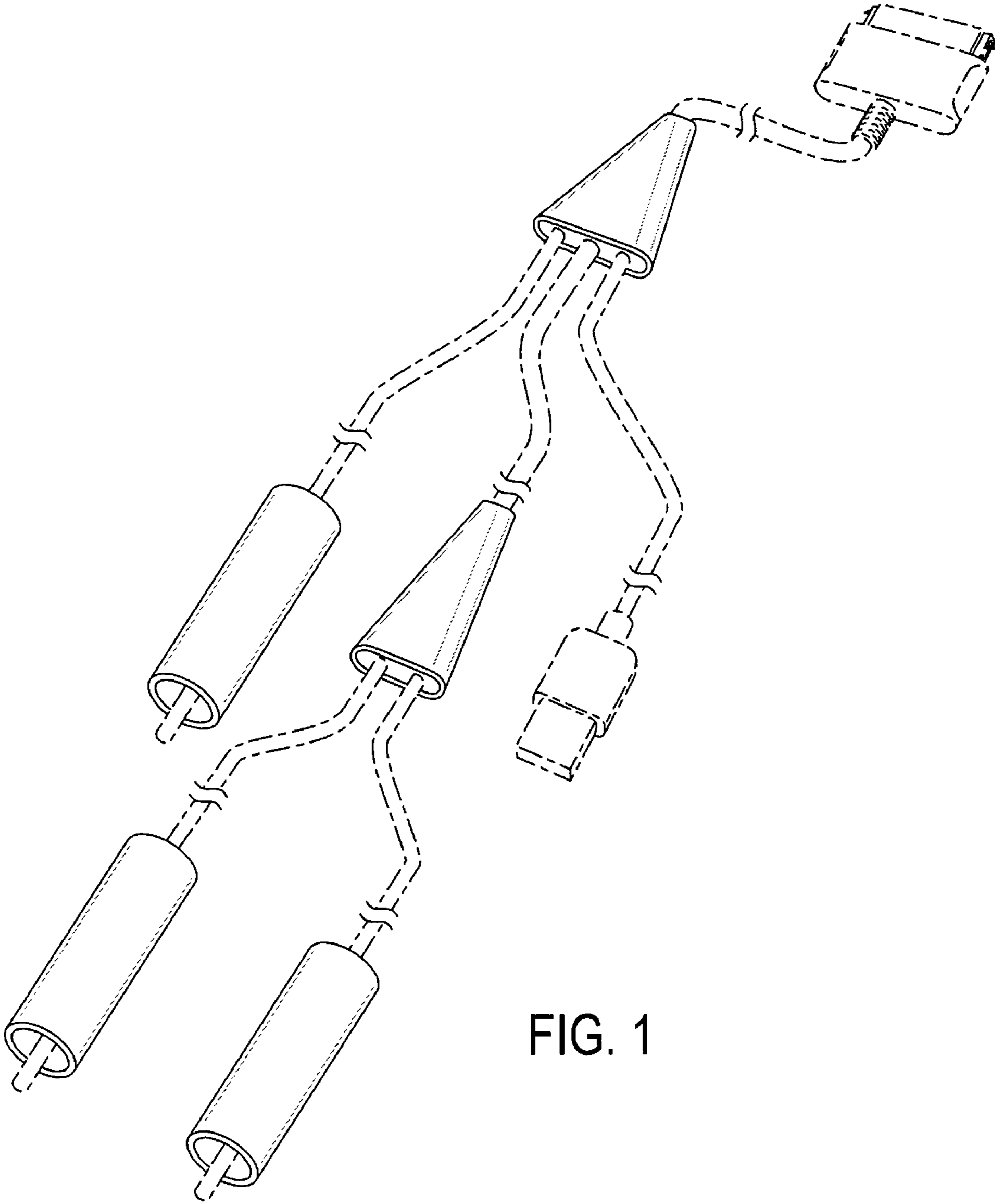

FIG. 1

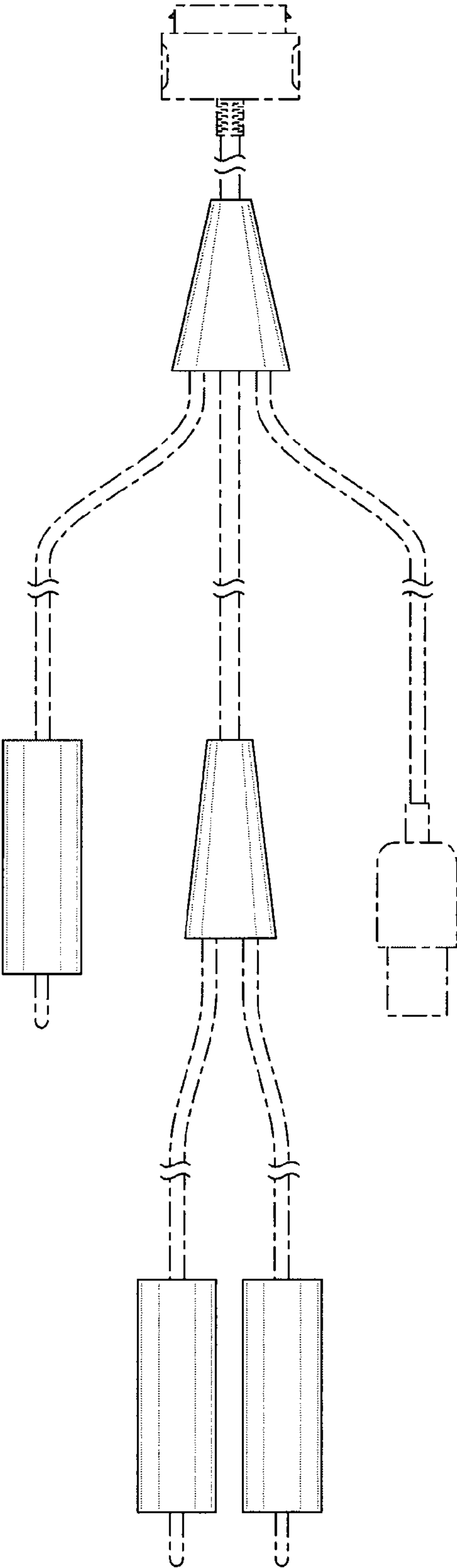

FIG. 2

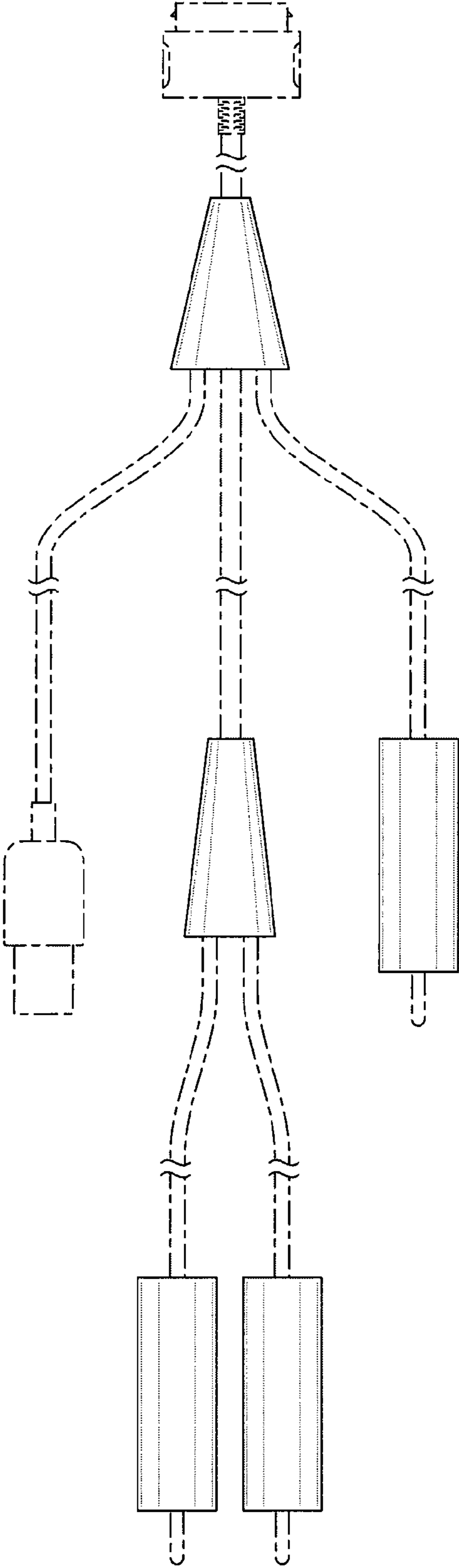

FIG. 3

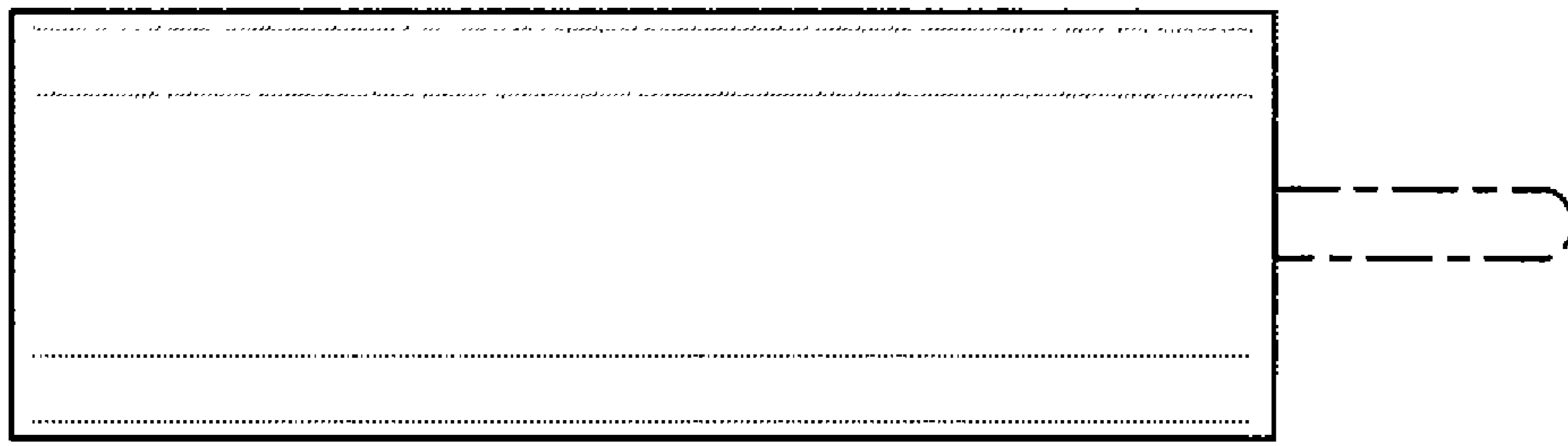

FIG. 4

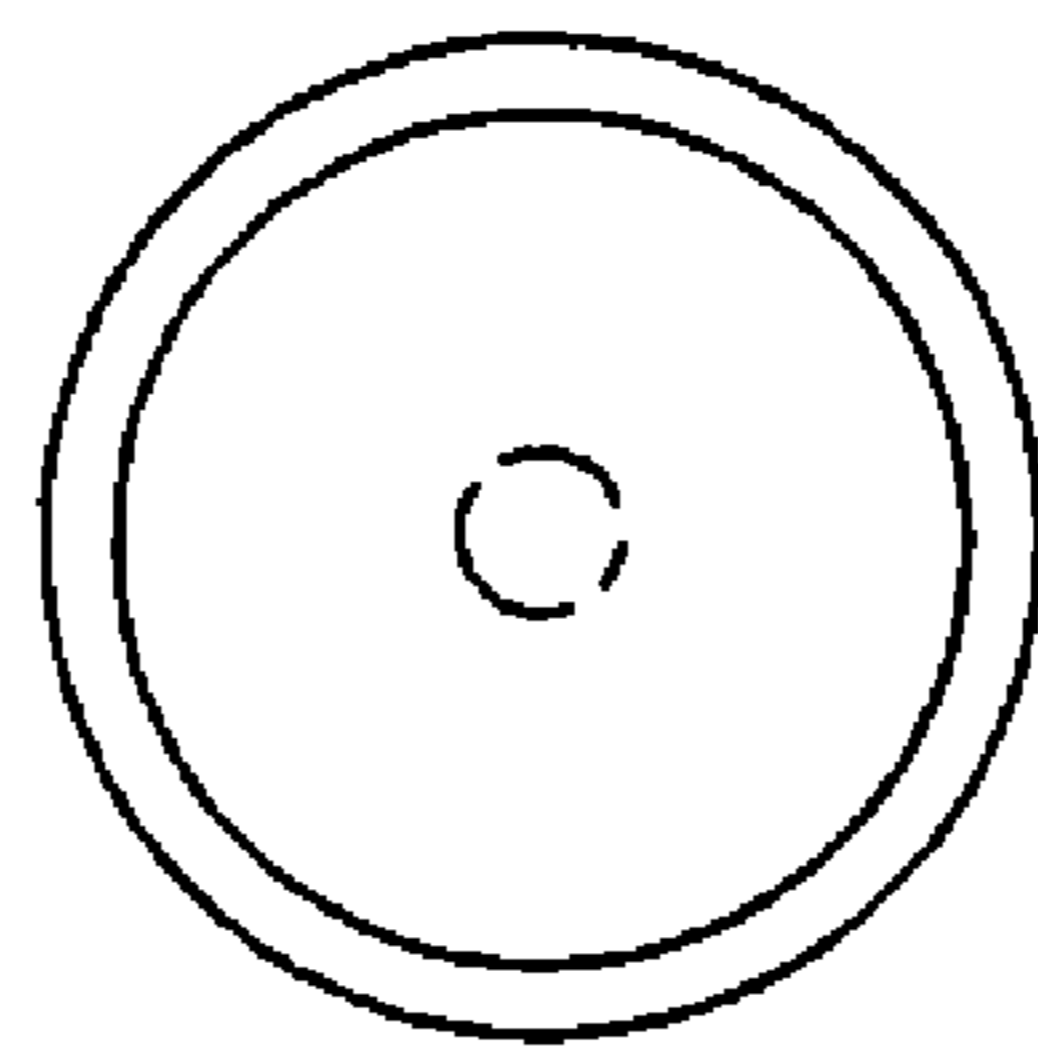

FIG. 5

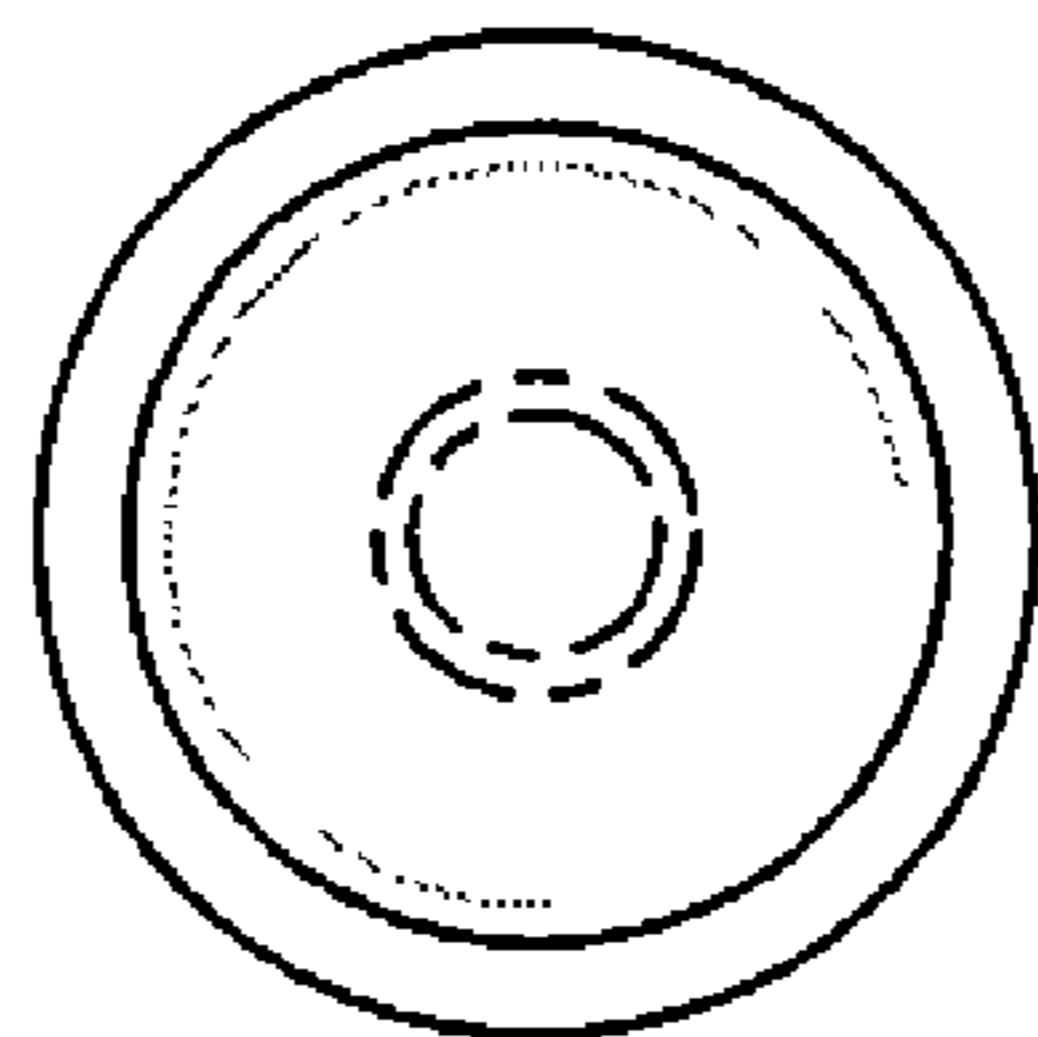

FIG. 6

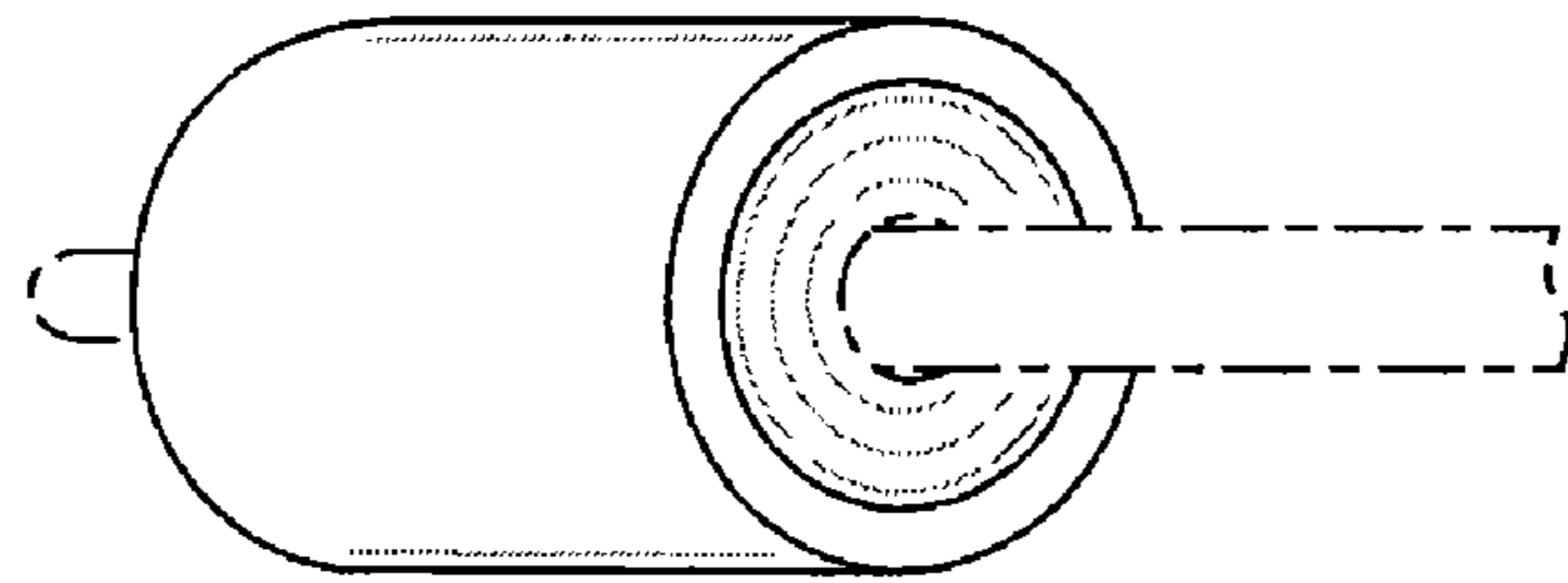

FIG. 7

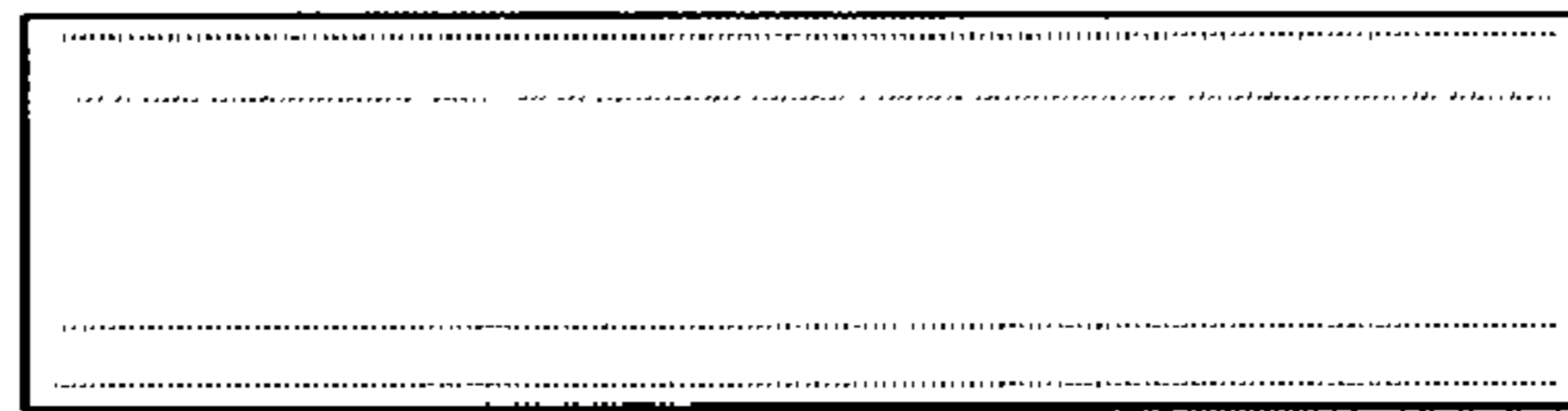

FIG. 8

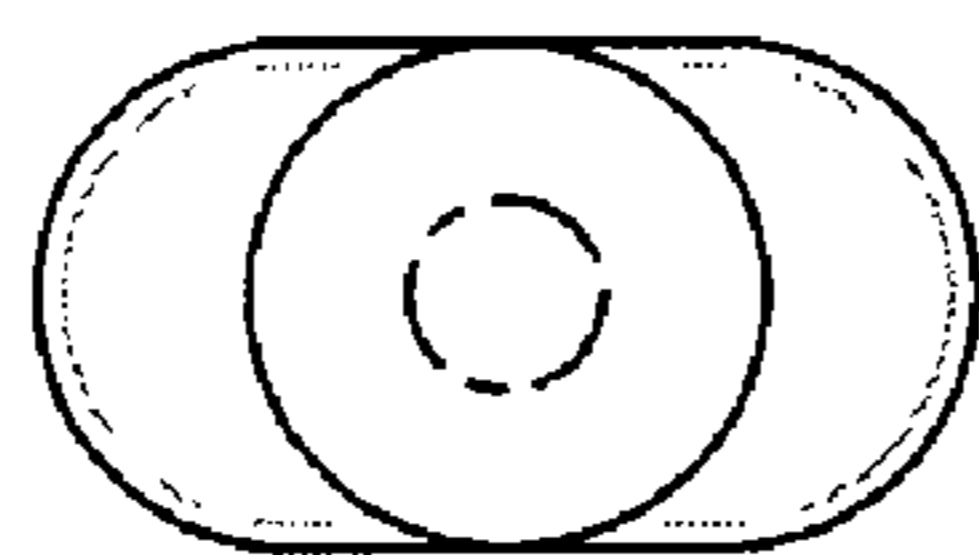

FIG. 9

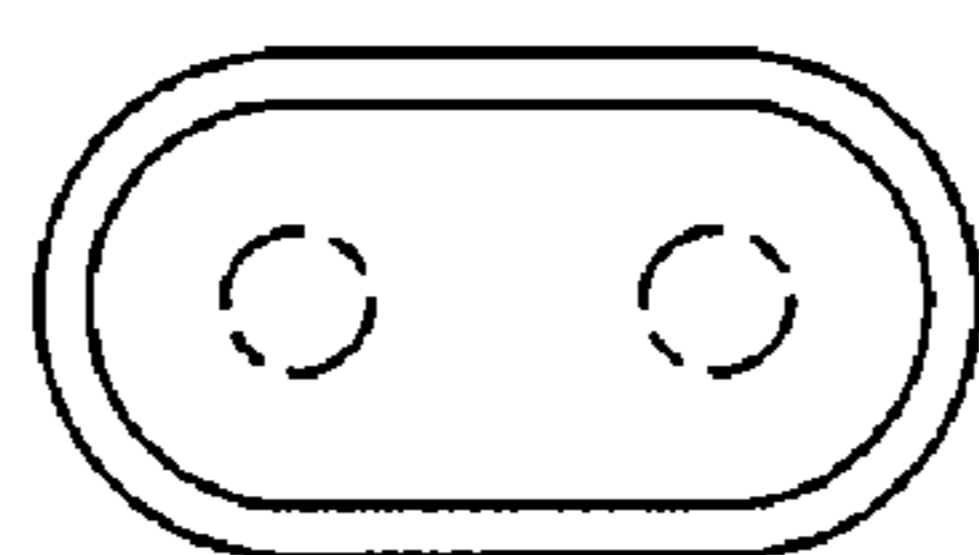

FIG. 10

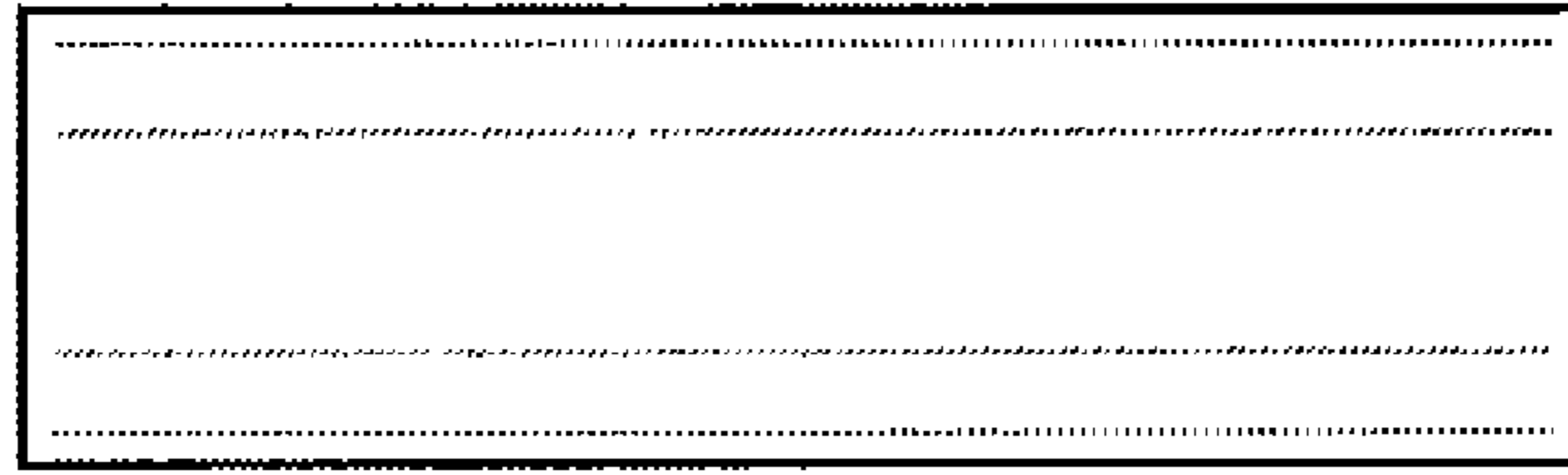

FIG. 11

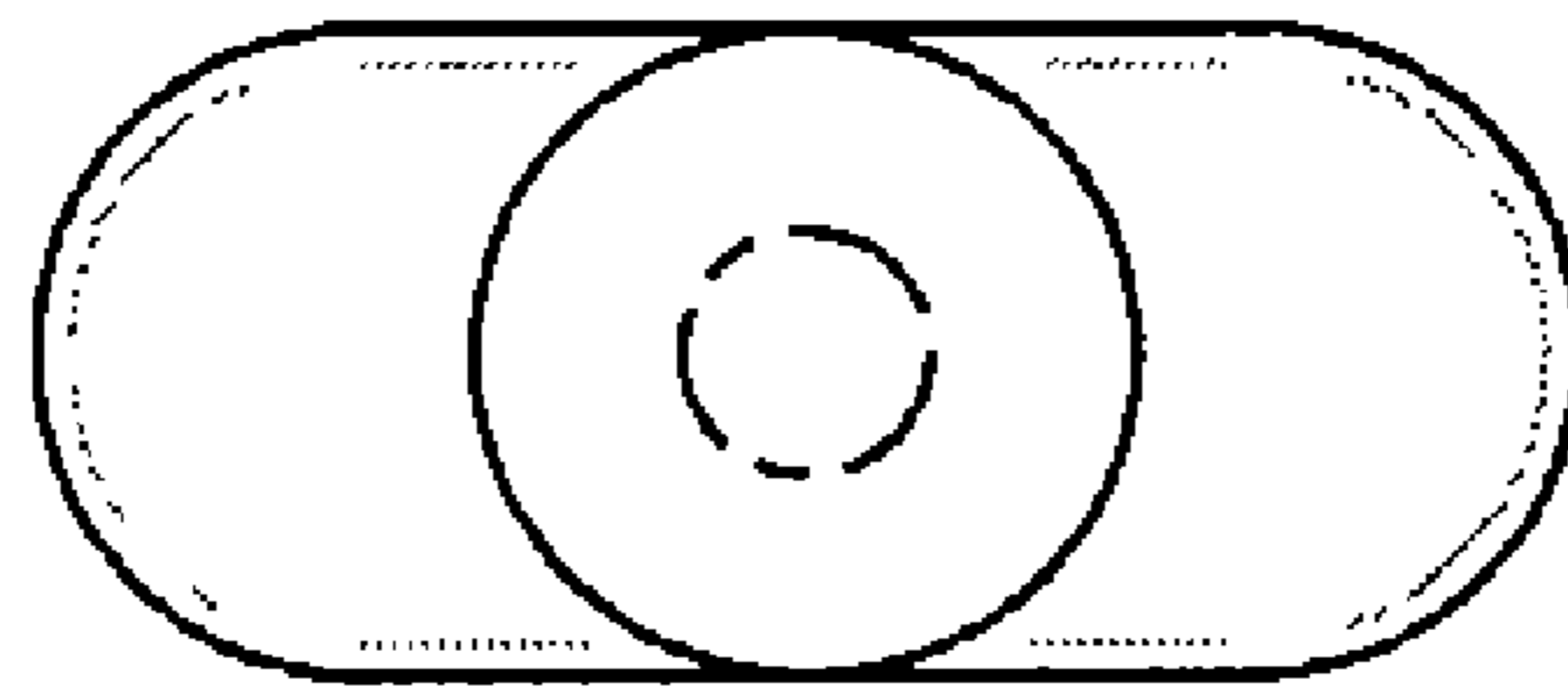

FIG. 12

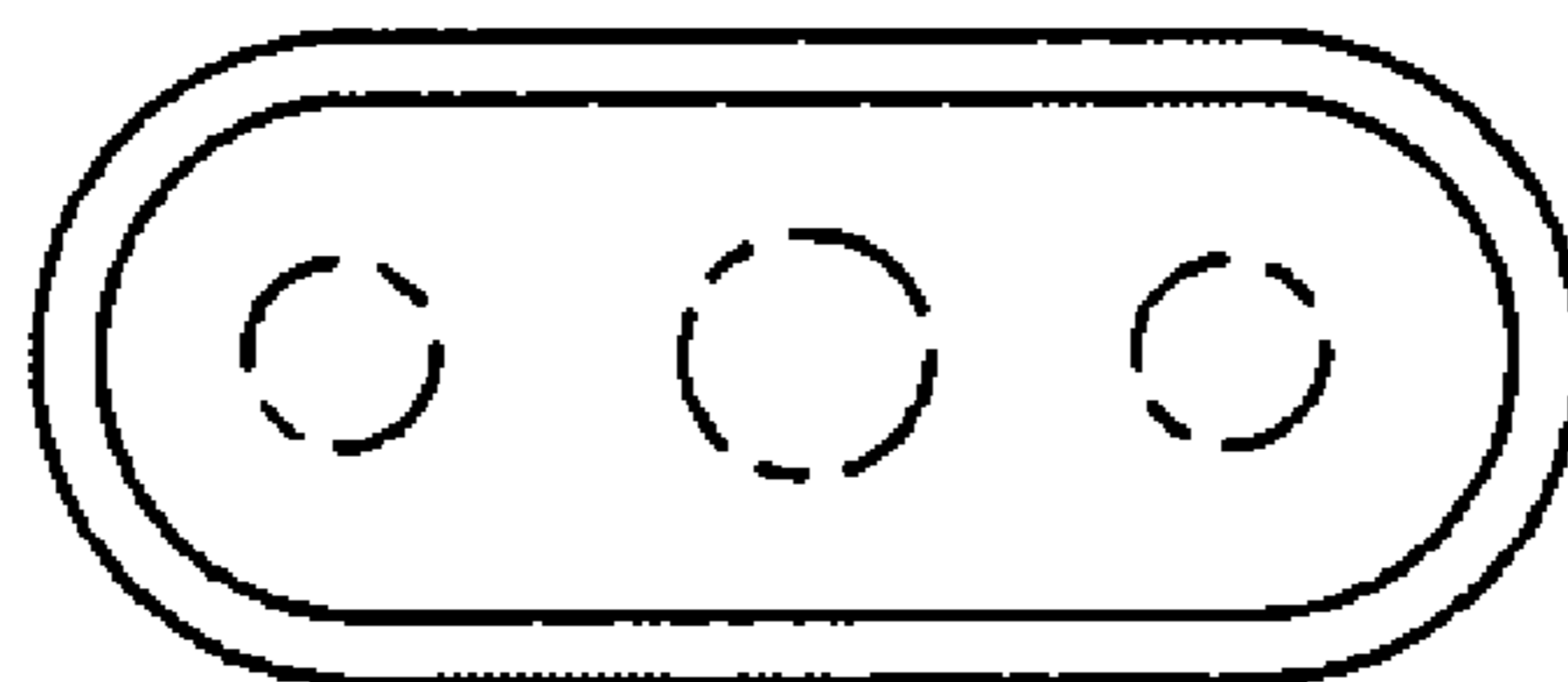

FIG. 13