



US00D585325S

(12) **United States Design Patent**
Rossmann

(10) **Patent No.:** **US D585,325 S**
(45) **Date of Patent:** **** Jan. 27, 2009**

(54) **GEMSTONE OR ORNAMENTAL OBJECT
MADE OF GLASS**

(75) Inventor: **Simone Rossmann**, Innsbruck (AT)

(73) Assignee: **Swarovski Aktiengesellschaft**, Triensen (LI)

(**) Term: **14 Years**

(21) Appl. No.: **29/300,931**

(22) Filed: **May 30, 2008**

(30) **Foreign Application Priority Data**

Dec. 7, 2007 (EM) 000839287

(51) **LOC (9) Cl.** **11-01**

(52) **U.S. Cl.** **D11/90**

(58) **Field of Classification Search** D11/1-2,
D11/26-29, 89-92; 63/26-28, 32

See application file for complete search history.

(56) **References Cited**

U.S. PATENT DOCUMENTS

D62,922 S *	8/1923	Simmons	D11/34
D239,534 S *	4/1976	Michaeli	D7/396.2
D543,891 S *	6/2007	Granig	D11/90
D543,893 S *	6/2007	Tabertshofer	D11/90
D544,393 S *	6/2007	Tabertshofer	D11/90
D560,541 S *	1/2008	Granig	D11/90
D560,547 S *	1/2008	Kumar	D11/90
D560,548 S *	1/2008	Granig	D11/90

* cited by examiner

Primary Examiner—R. Seifert

(74) Attorney, Agent, or Firm—Wenderoth, Lind & Ponack,
L.L.P.

(57) **CLAIM**

The ornamental design for the gemstone or ornamental object made of glass, as shown and described.

DESCRIPTION

FIG. 1 is a bottom view of the gemstone or ornamental object made of glass according to a first embodiment;

FIG. 2 is a right end view of the gemstone or ornamental object made of glass according to the first embodiment;

FIG. 3 is a front view of the gemstone or ornamental object made of glass according to the first embodiment;

FIG. 4 is a left end view of the gemstone or ornamental object made of glass according to the first embodiment;

FIG. 5 is a rear view of the gemstone or ornamental object made of glass according to the first embodiment;

FIG. 6 is a top view of the gemstone or ornamental object made of glass according to the first embodiment;

FIG. 7 is a prospective view of the gemstone or ornamental object made of glass according to a first embodiment;

FIG. 8 is a bottom view of the gemstone or ornamental object made of glass according to a second embodiment;

FIG. 9 is a right end view of the gemstone or ornamental object made of glass according to the second embodiment;

FIG. 10 is a front view of the gemstone or ornamental object made of glass according to the second embodiment;

FIG. 11 is a left end view of the gemstone or ornamental object made of glass according to the second embodiment;

FIG. 12 is a rear view of the gemstone or ornamental object made of glass according to the second embodiment;

FIG. 13 is a top view of the gemstone or ornamental object made of glass according to the second embodiment; and,

FIG. 14 is a prospective view of the gemstone or ornamental object made of glass according to a second embodiment.

1 Claim, 2 Drawing Sheets

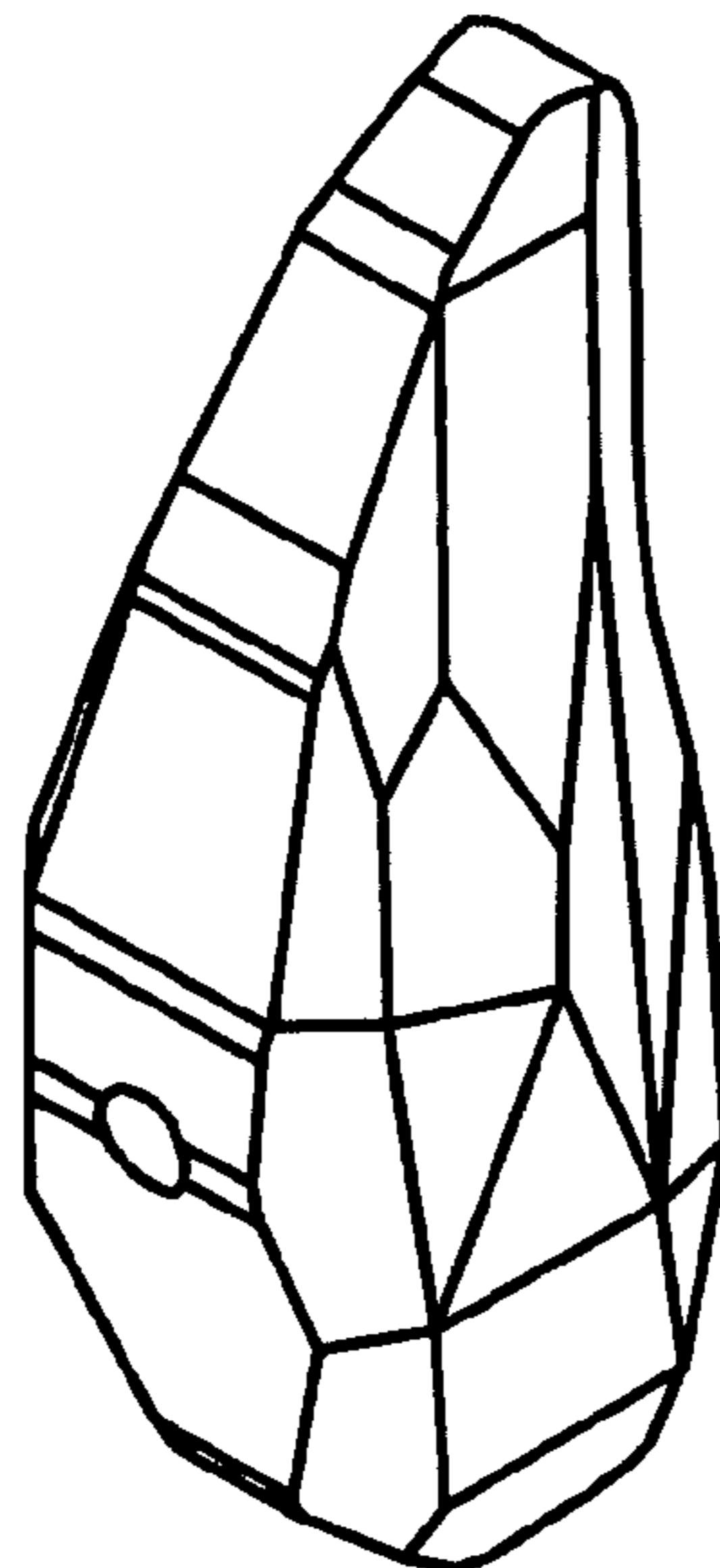

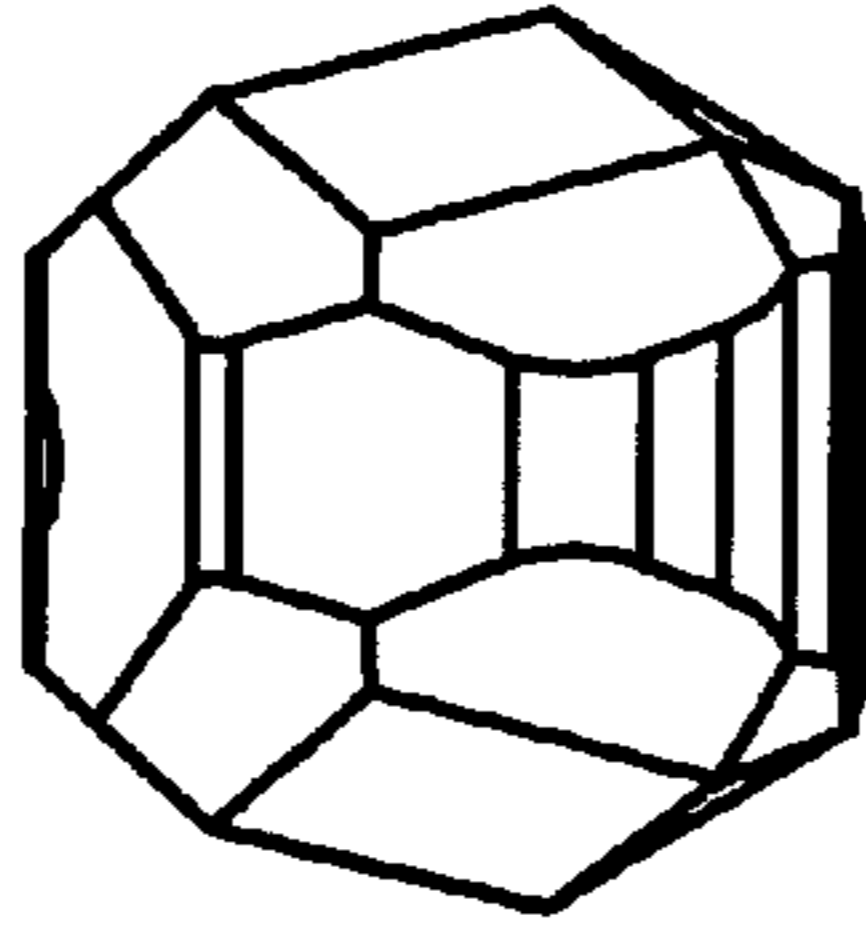

Fig. 1

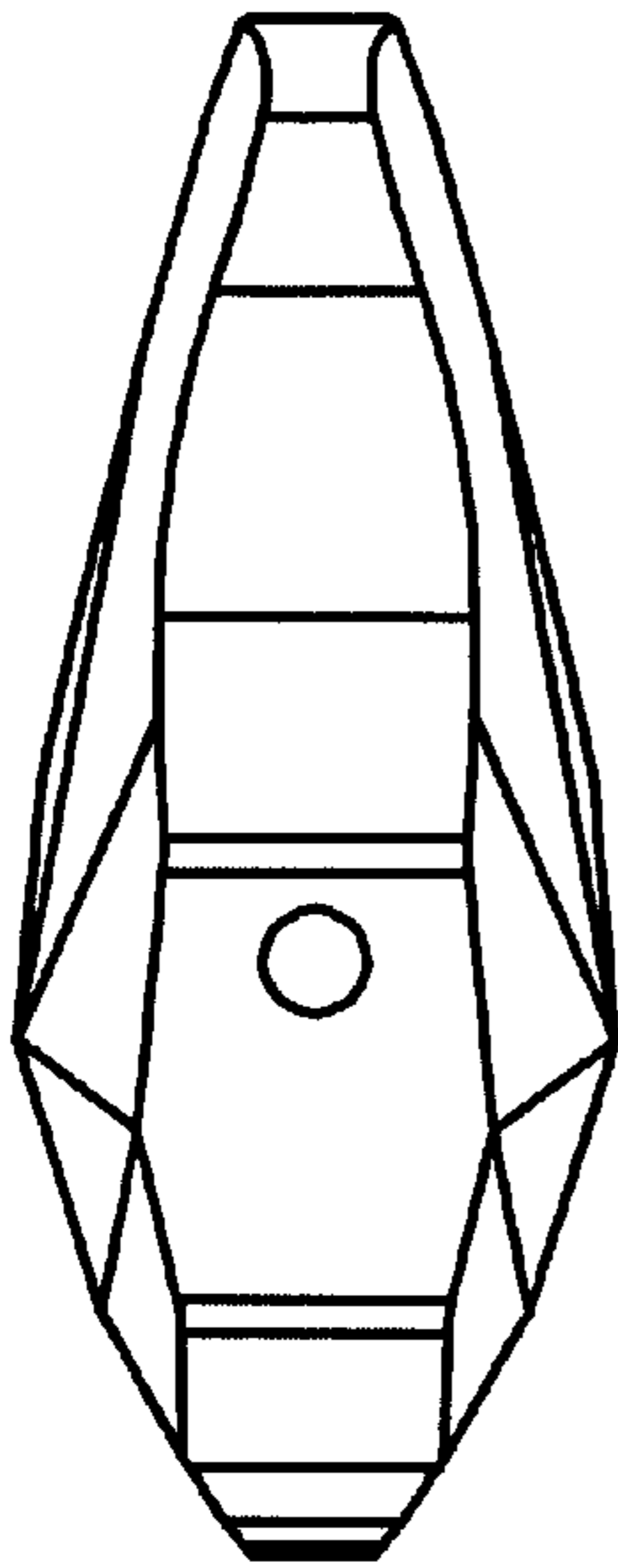

Fig. 2

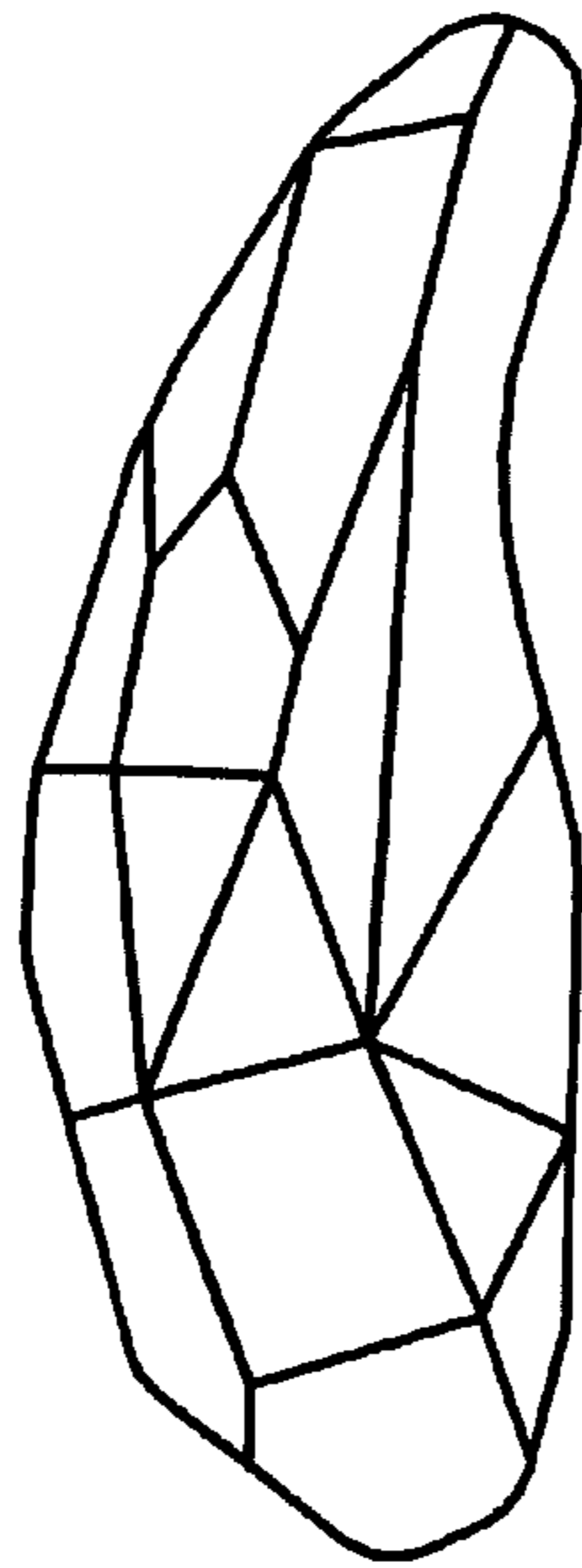

Fig. 3

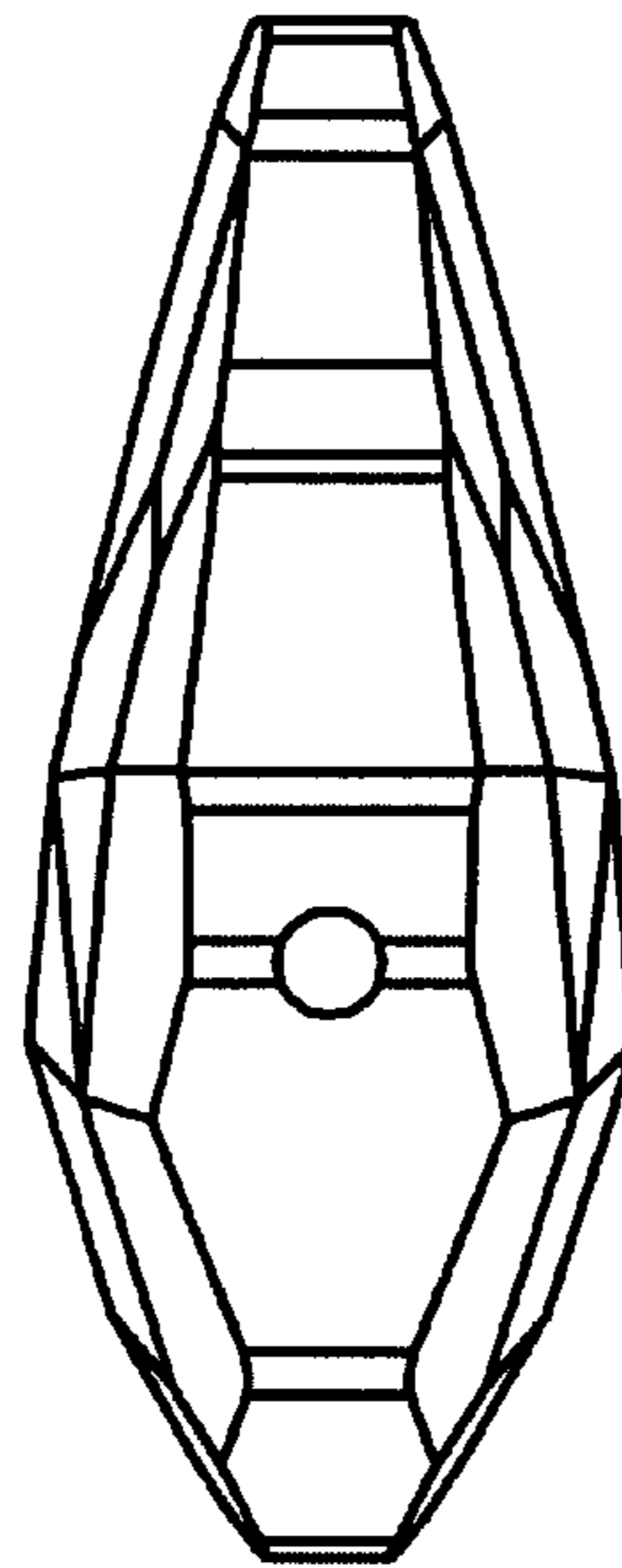

Fig. 4

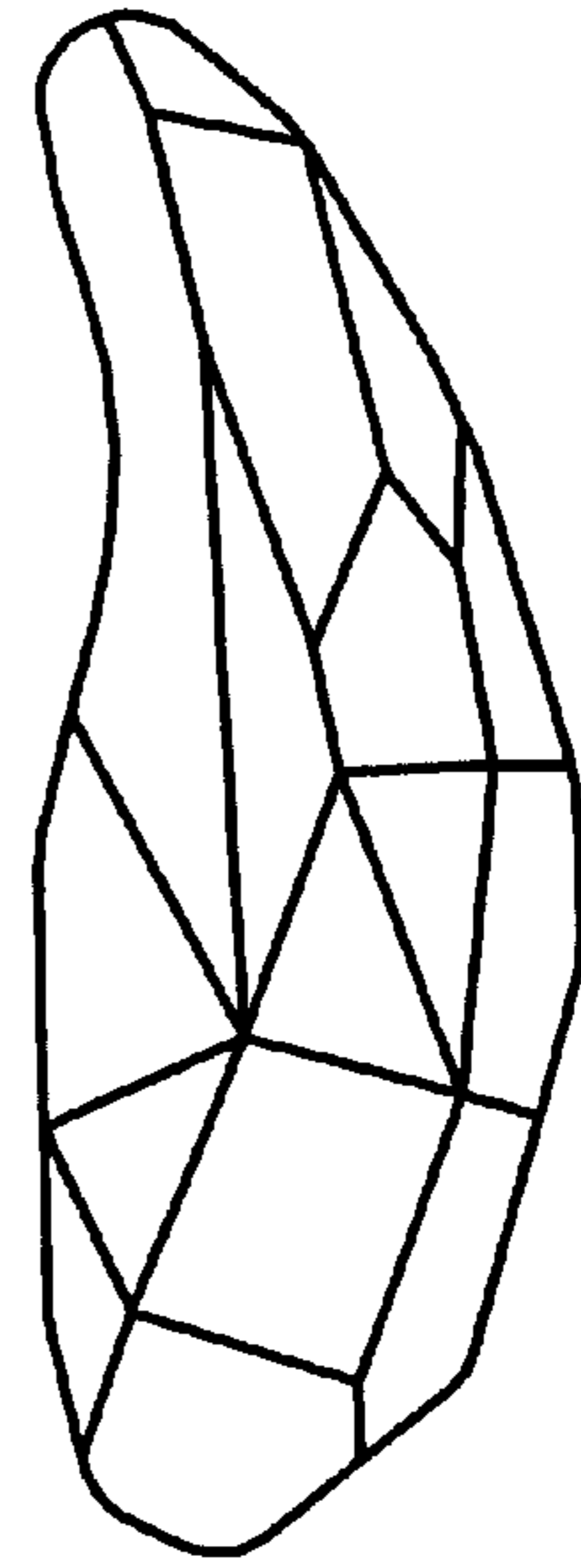

Fig. 5

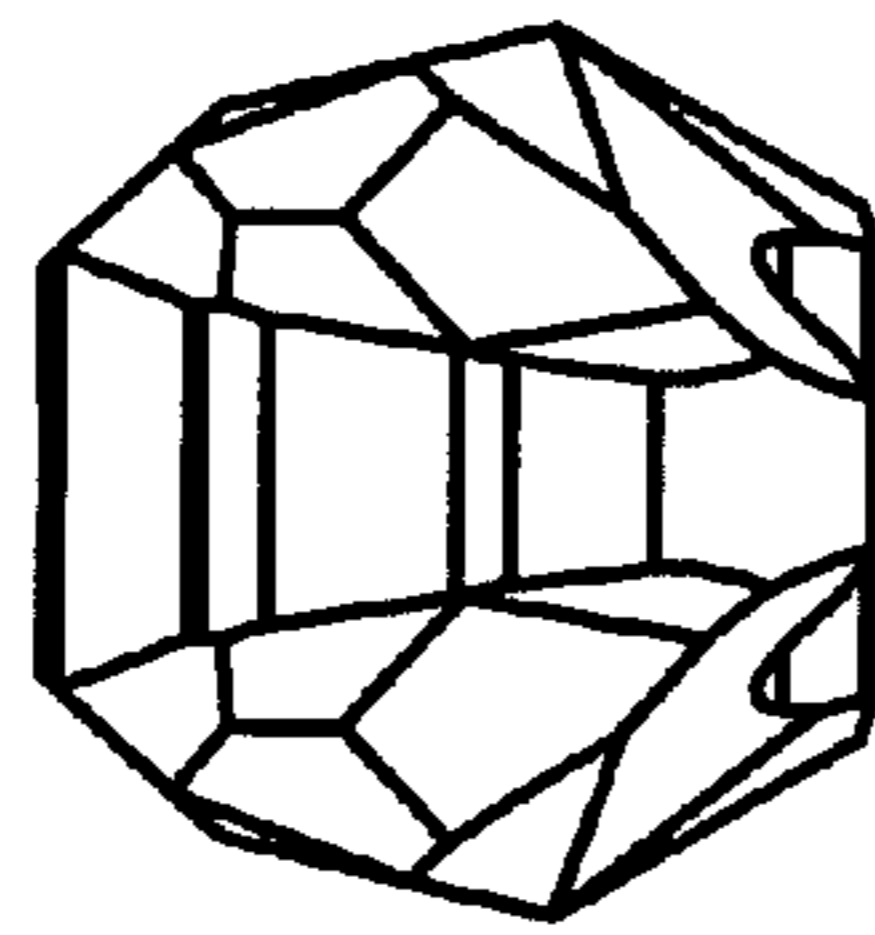

Fig. 6

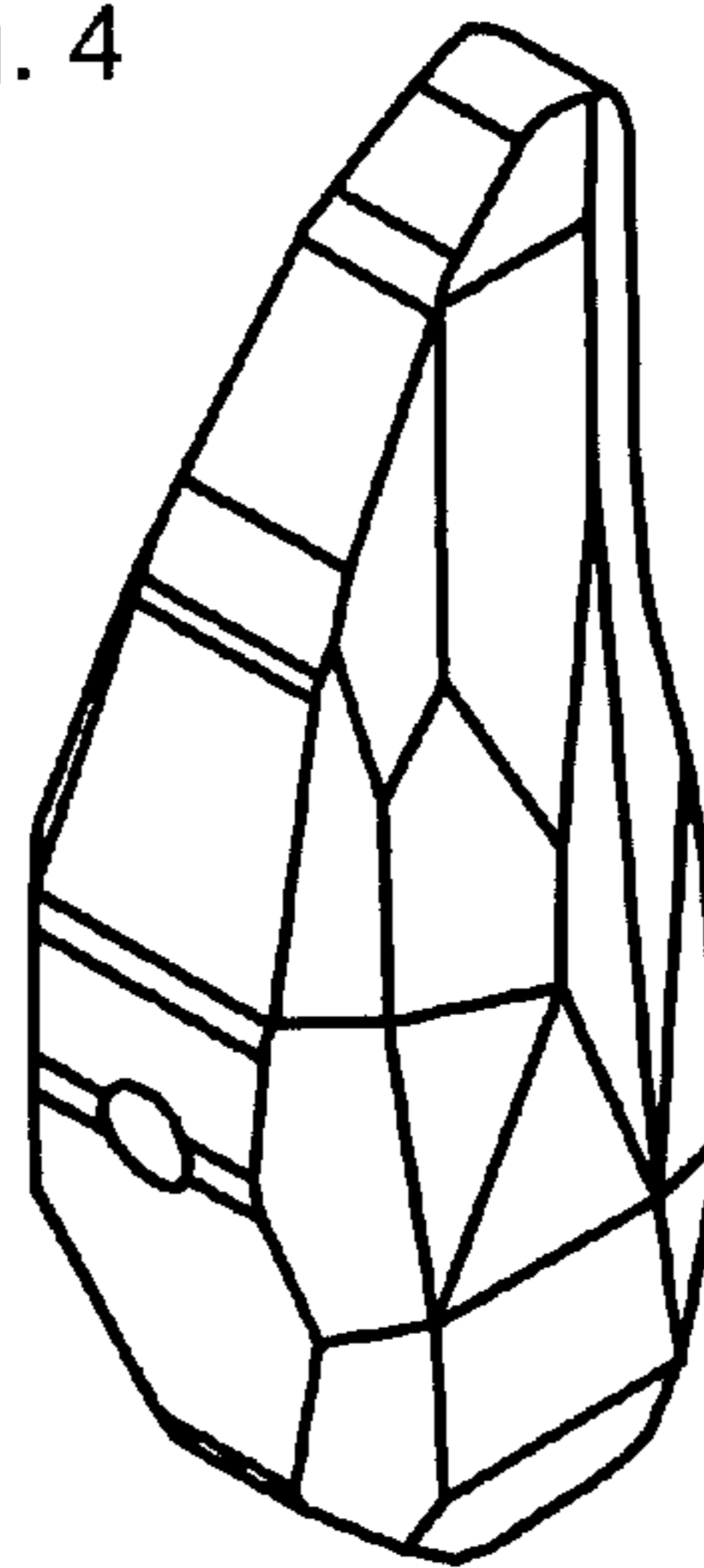

Fig. 7

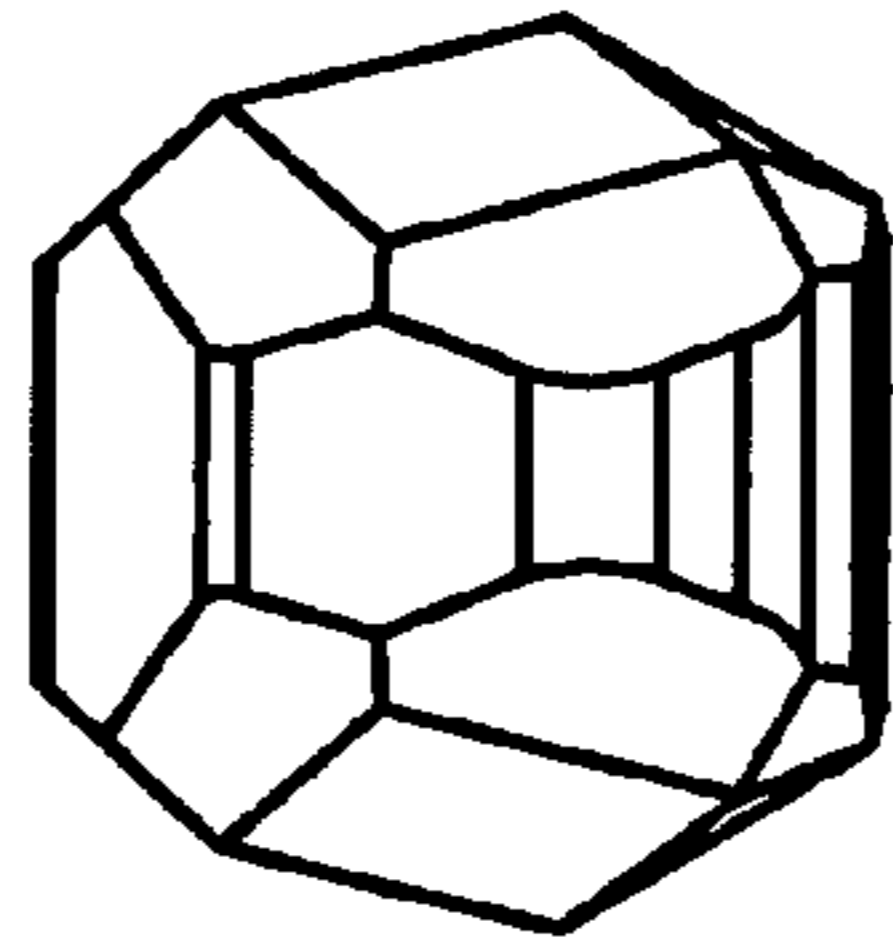

Fig. 8

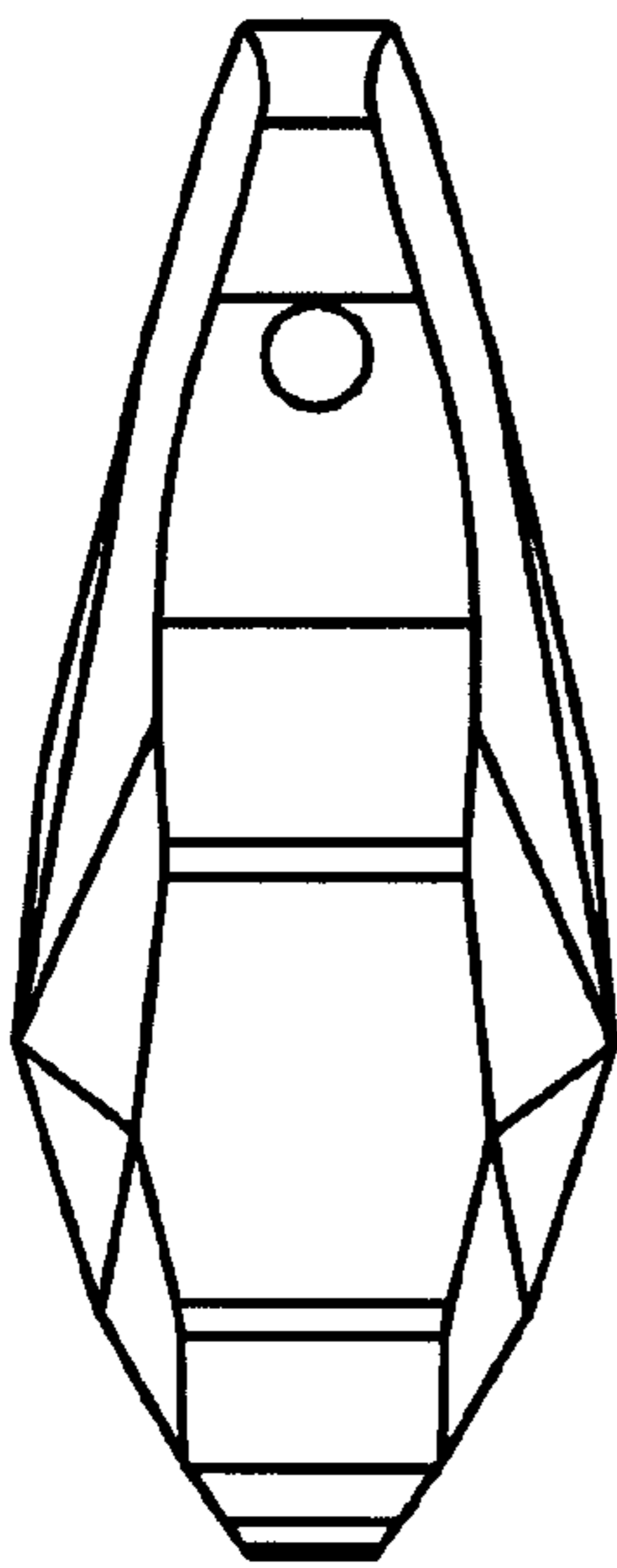

Fig. 9

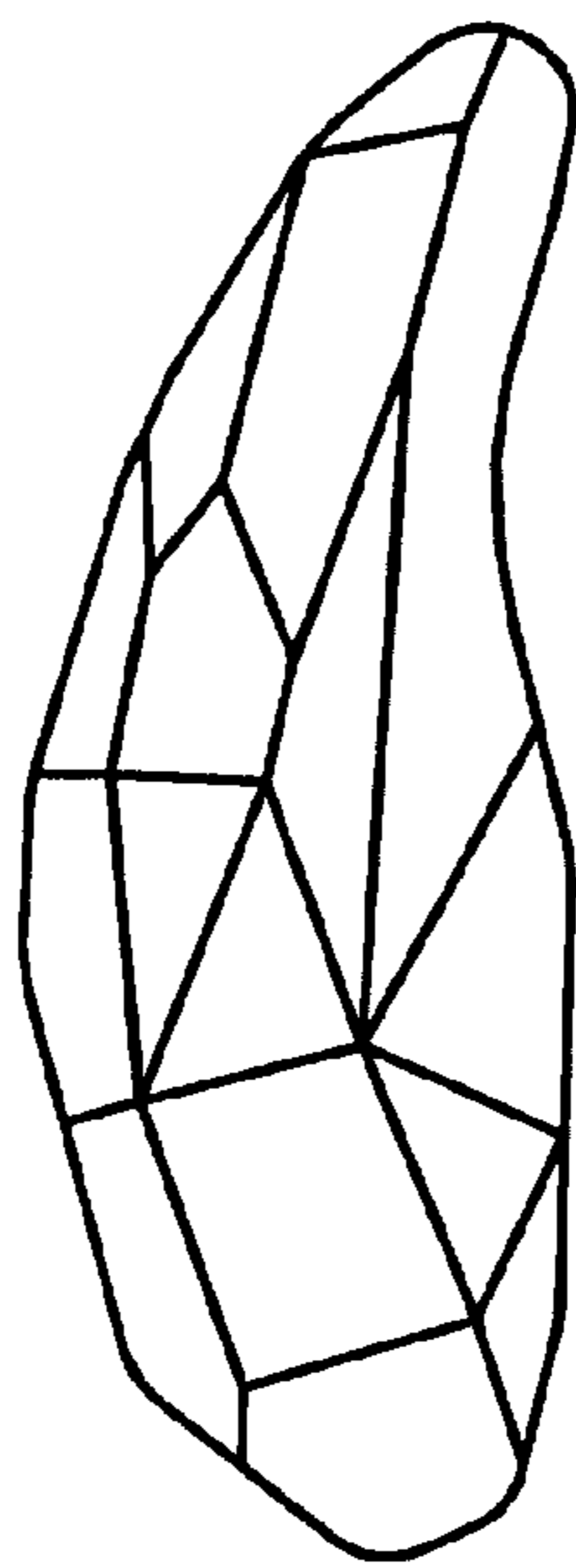

Fig. 10

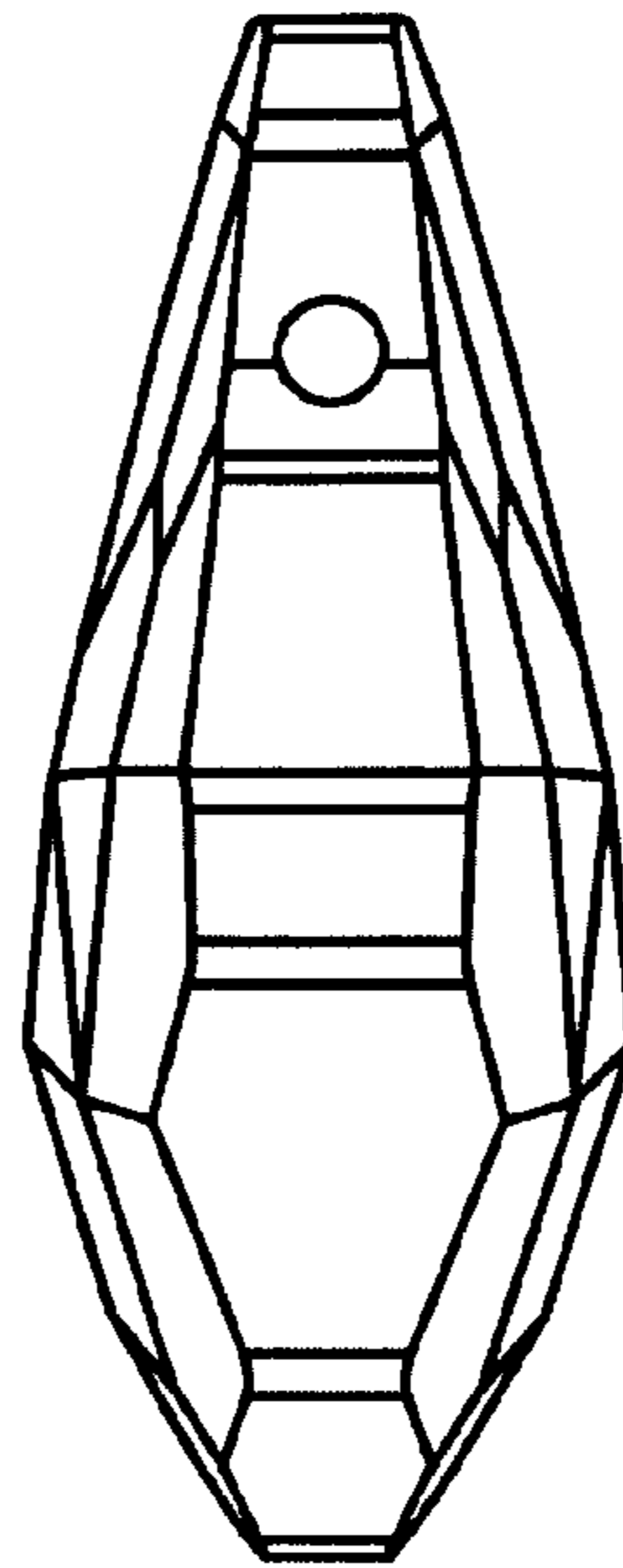

Fig. 11

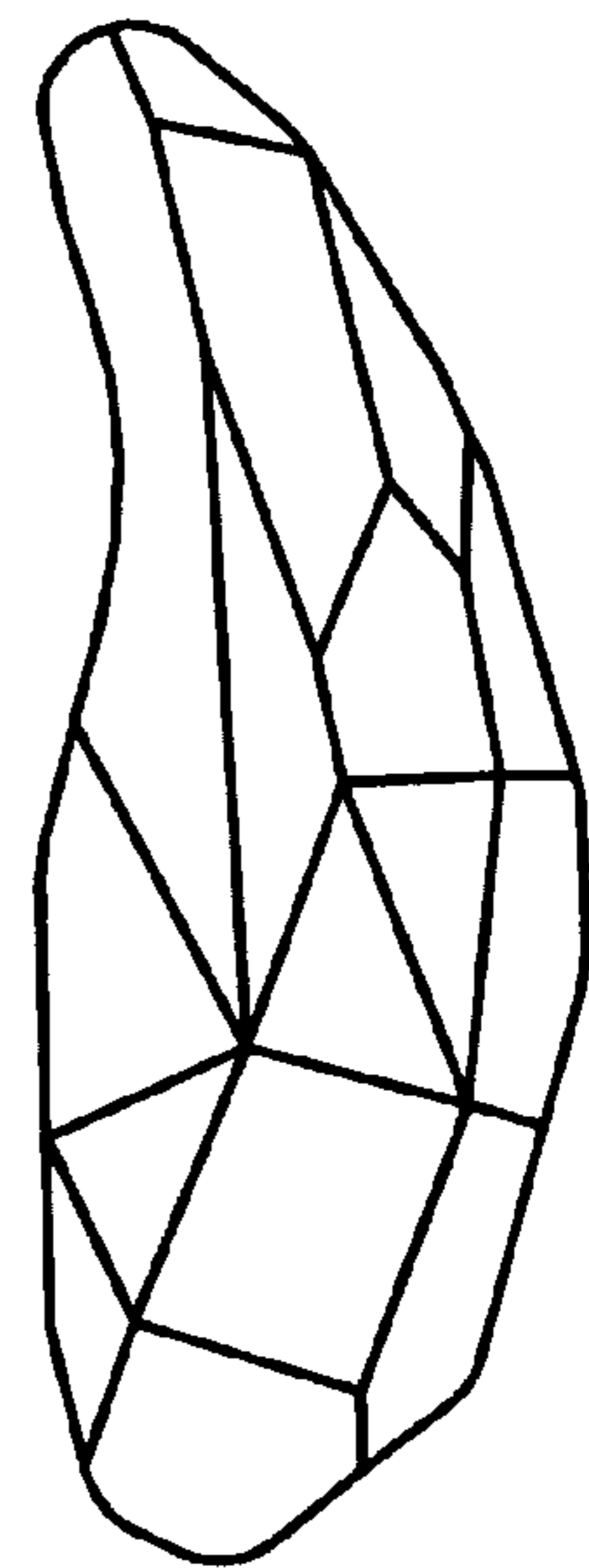

Fig. 12

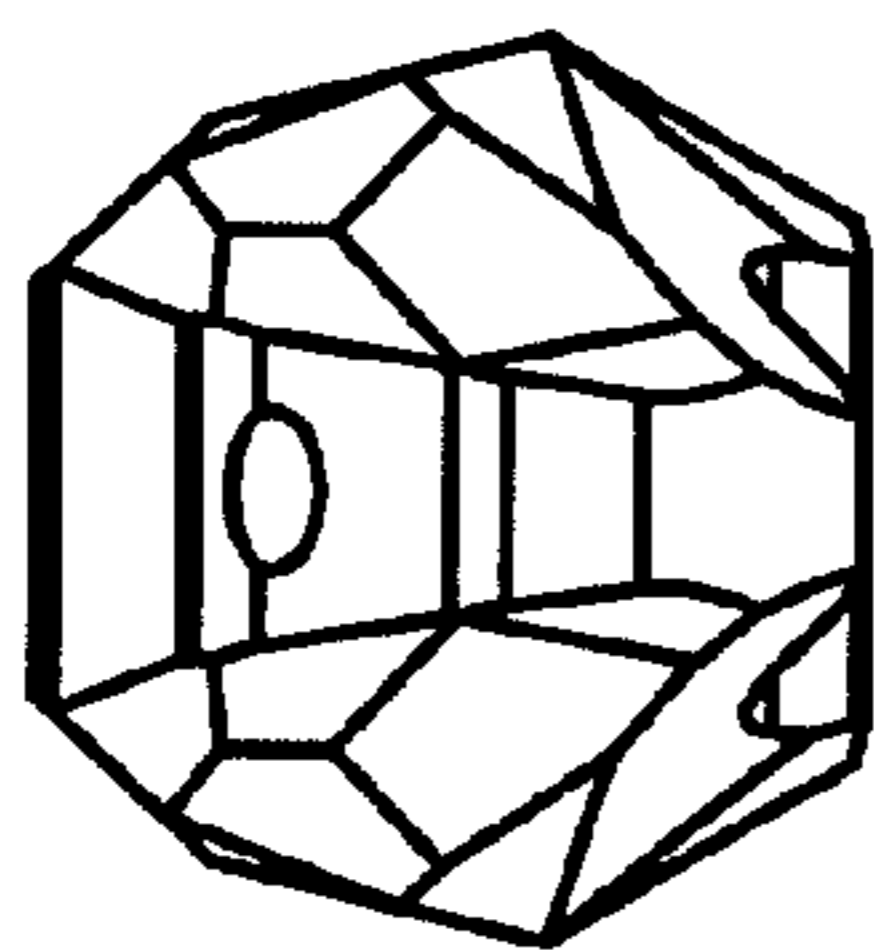

Fig. 13

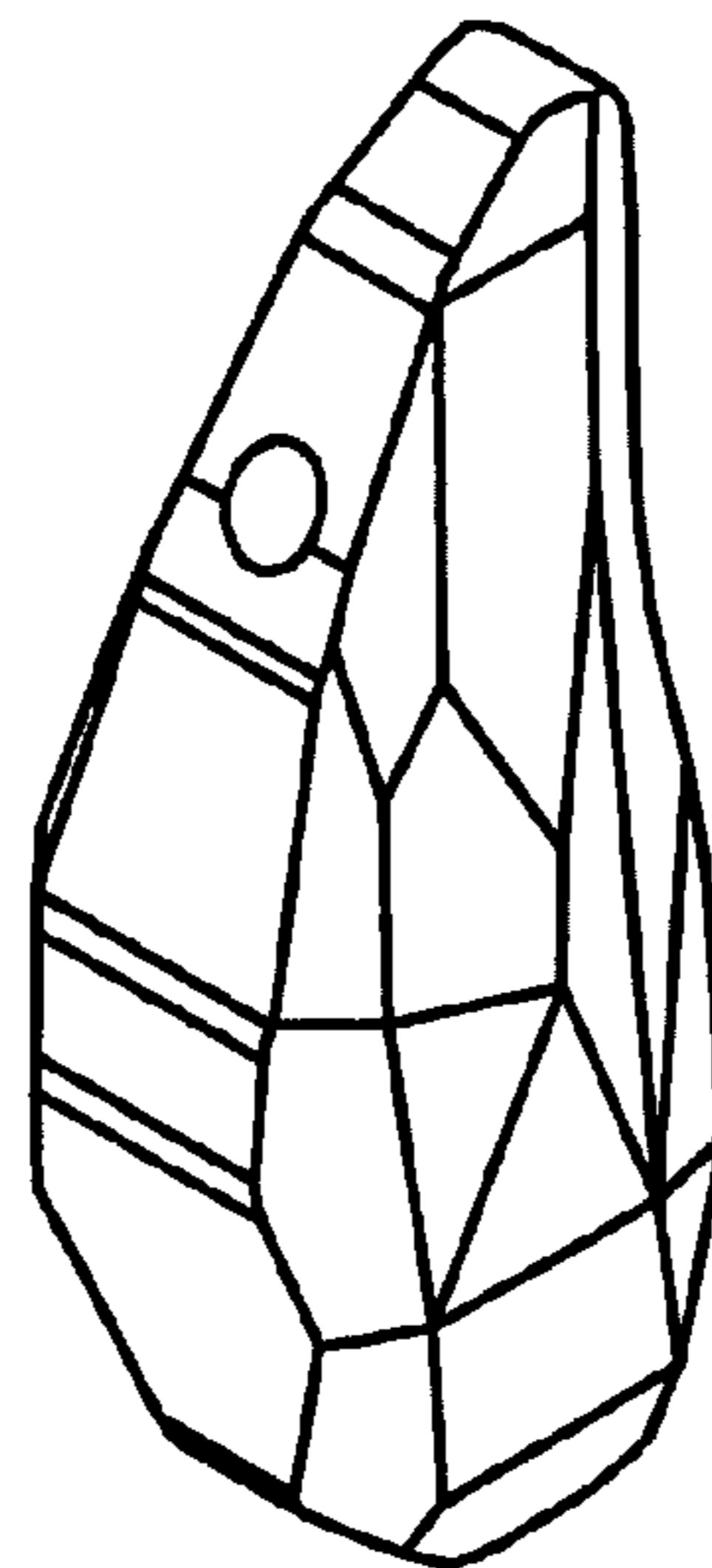

Fig. 14