



US00D585300S

(12) **United States Design Patent**
Domoy et al.

(10) **Patent No.:** **US D585,300 S**
(45) **Date of Patent:** **** Jan. 27, 2009**

(54) **CONTAINER FOR PERSONAL CARE COMPOSITIONS**

(75) Inventors: **Brett Christopher Domoy**, Trumbull, CT (US); **Corinne Elizabeth Elstow**, Marlborough (GB); **Michael George Hurley**, Trumbull, CT (US); **John David Lamb**, Marlborough (GB); **William John Maskell**, Marlborough (GB); **Thomas Robert Walton**, Marlborough (GB); **Alan David Whiting**, Penrith (GB)

(73) Assignee: **Conopco, Inc.**, Englewood Cliffs, NJ (US)

(**) Term: **14 Years**

(21) Appl. No.: **29/307,270**

(22) Filed: **Apr. 10, 2008**

(30) **Foreign Application Priority Data**

Oct. 11, 2007 (GB) 4004657

(51) **LOC (9) Cl.** **09-03**

(52) **U.S. Cl.** **D9/695**

(58) **Field of Classification Search** D9/695-699, D9/544, 435, 440, 454, 723-724, 521, 711, D9/504; 222/92, 107, 96, 527-529; 206/438, 206/822; D28/7, 76, 82; 220/DIG. 7
See application file for complete search history.

(56) **References Cited**

U.S. PATENT DOCUMENTS

D281,055 S * 10/1985 Dombroski D9/697
D338,397 S * 8/1993 Sun et al. D9/697

D370,415 S * 6/1996 Seppala D9/537
D383,383 S * 9/1997 Prestia et al. D9/521
D392,879 S * 3/1998 Couey D9/697
D425,408 S * 5/2000 Bakic D9/695
D436,029 S * 1/2001 Jones et al. D9/699
D460,917 S * 7/2002 Trabal D9/551
D465,412 S * 11/2002 Addis et al. D9/562
D488,059 S * 4/2004 Mounier D9/697
D532,701 S * 11/2006 Spencer D9/699
D558,061 S * 12/2007 Py et al. D9/695
D572,601 S * 7/2008 Chang D9/697

* cited by examiner

Primary Examiner—Caron Veynar

Assistant Examiner—Abraham Bahta

(74) *Attorney, Agent, or Firm*—Milton L. Honig

(57) **CLAIM**

The ornamental design for a container for personal care compositions, as shown and described.

DESCRIPTION

FIG. 1 is a perspective view of the container for personal care compositions showing our new design;

FIG. 2 is a front elevational view thereof;

FIG. 3 is a rear elevational view thereof;

FIG. 4 is a right side elevational view thereof;

FIG. 5 is a left side elevational view thereof;

FIG. 6 is a top plan view thereof; and,

FIG. 7 is a bottom plan view thereof.

The broken lines are present only for illustrative purposes to show other areas of the container but do not form part of the claimed design.

1 Claim, 2 Drawing Sheets

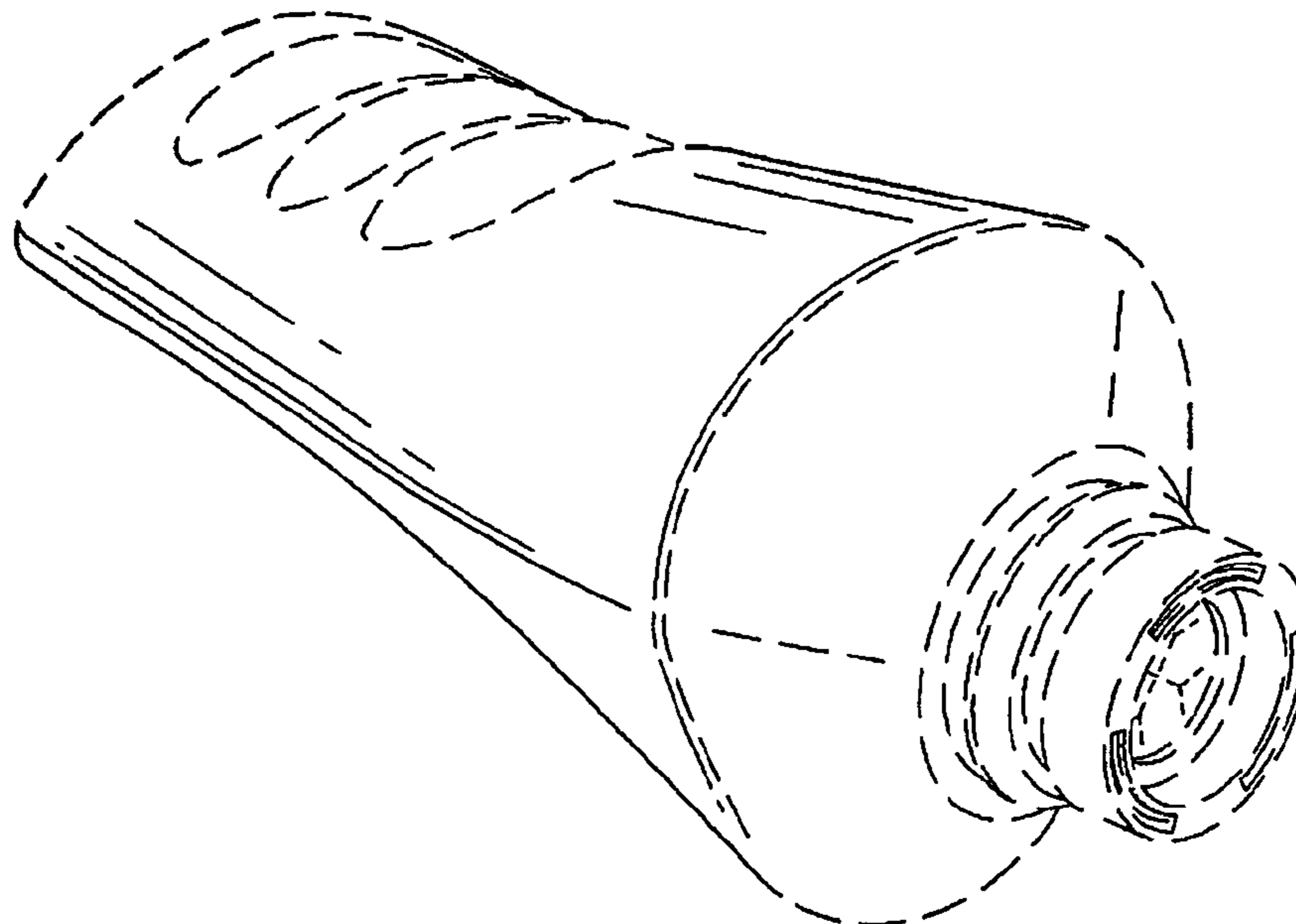

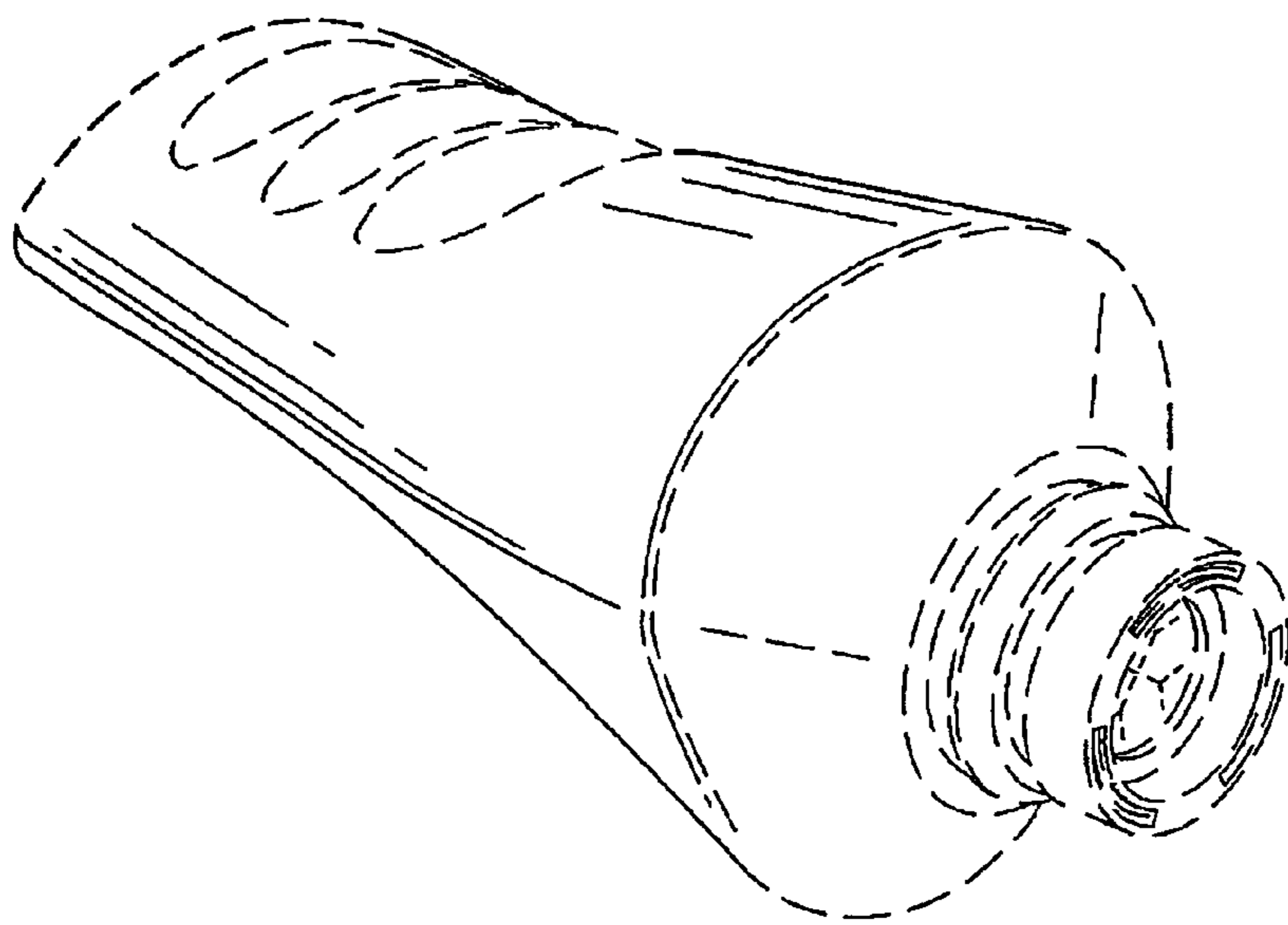

Fig. 1.

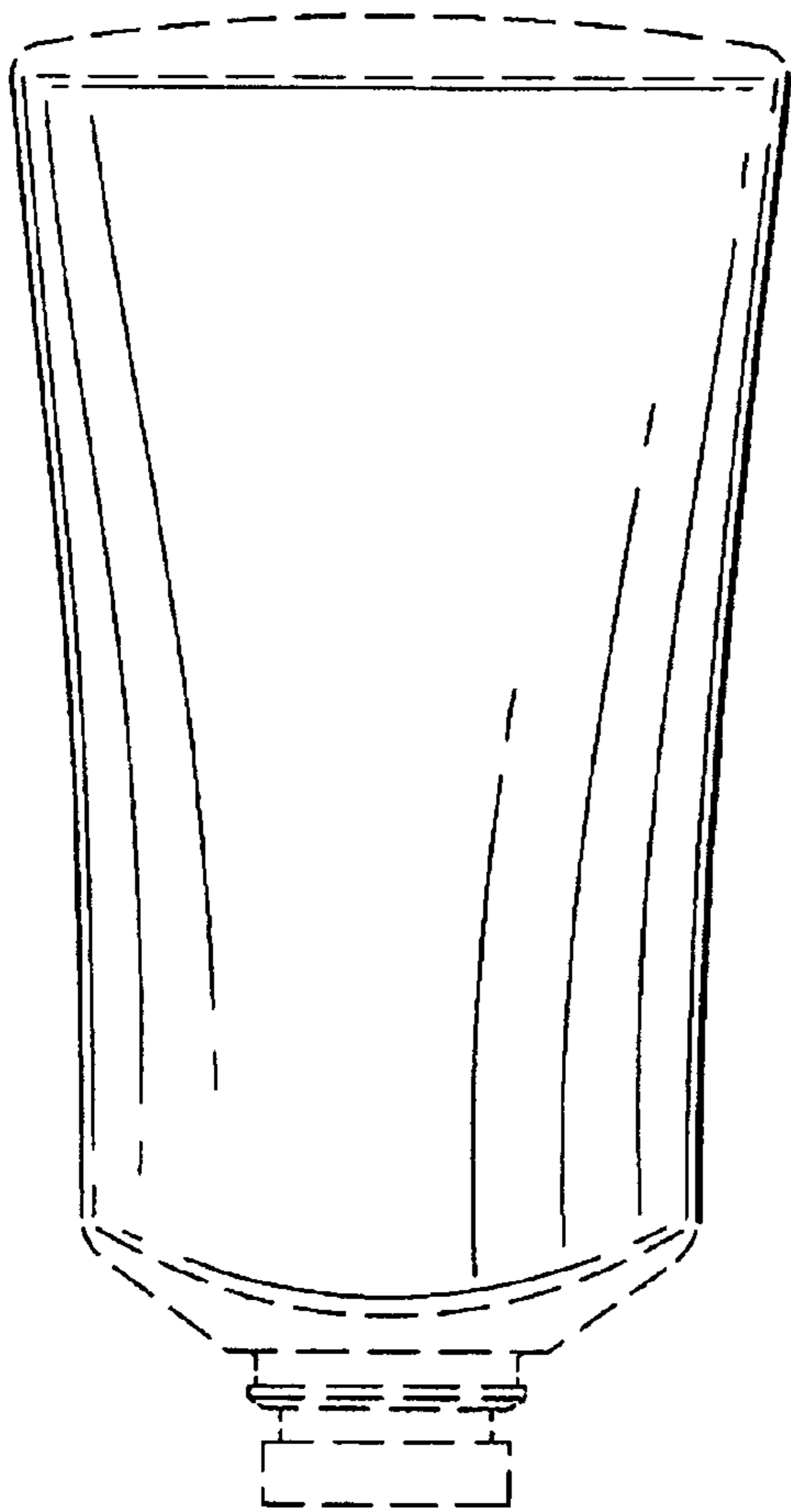

Fig. 2.

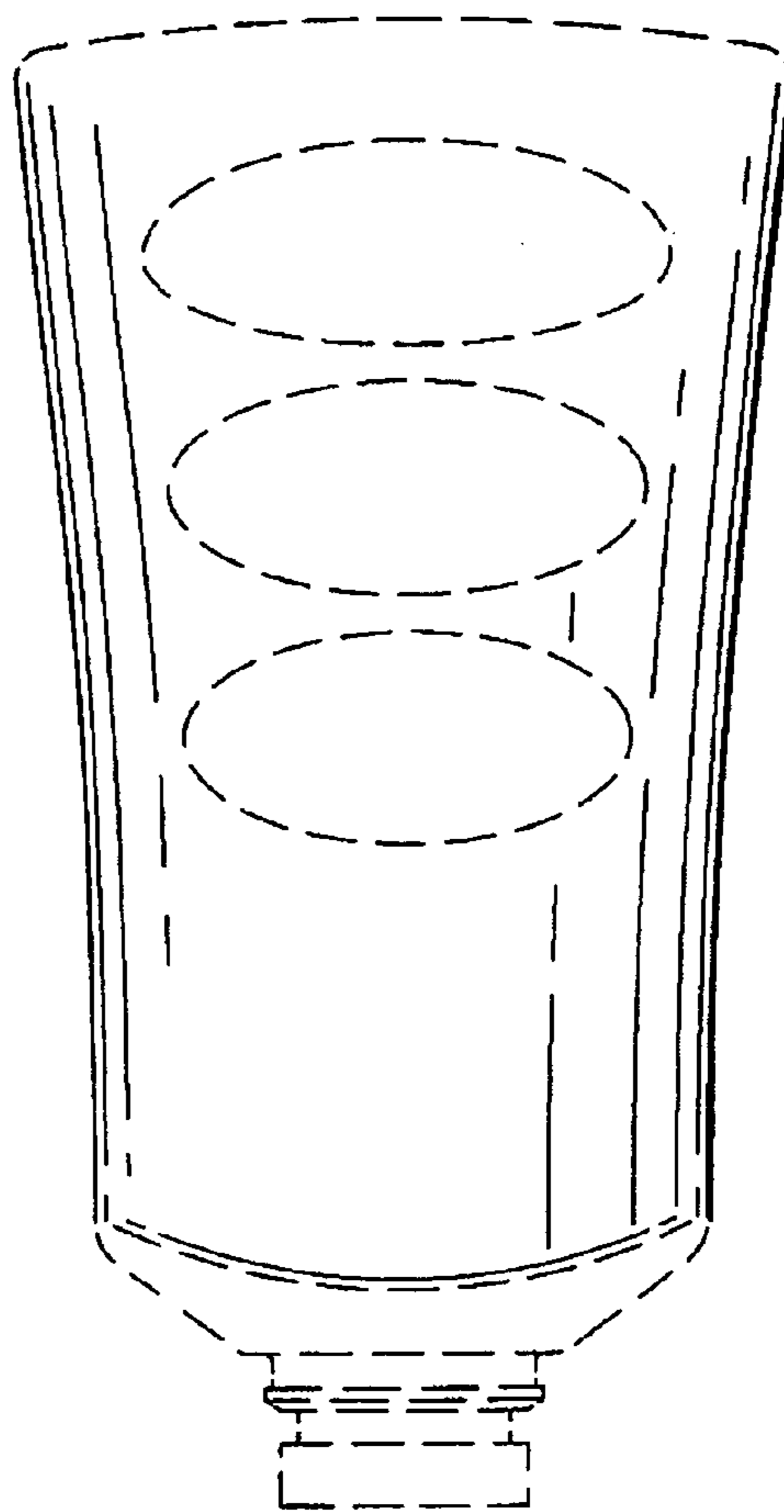

Fig. 3.

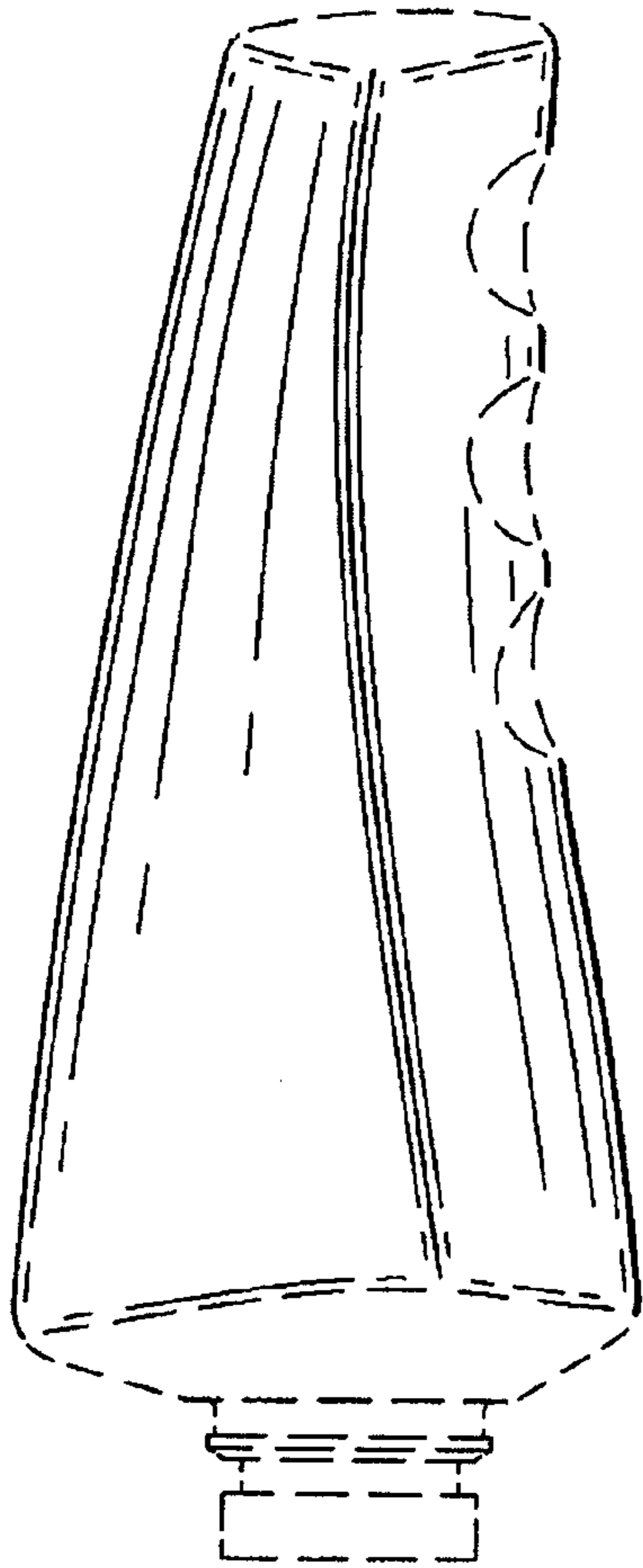

Fig.4.



Fig.5.

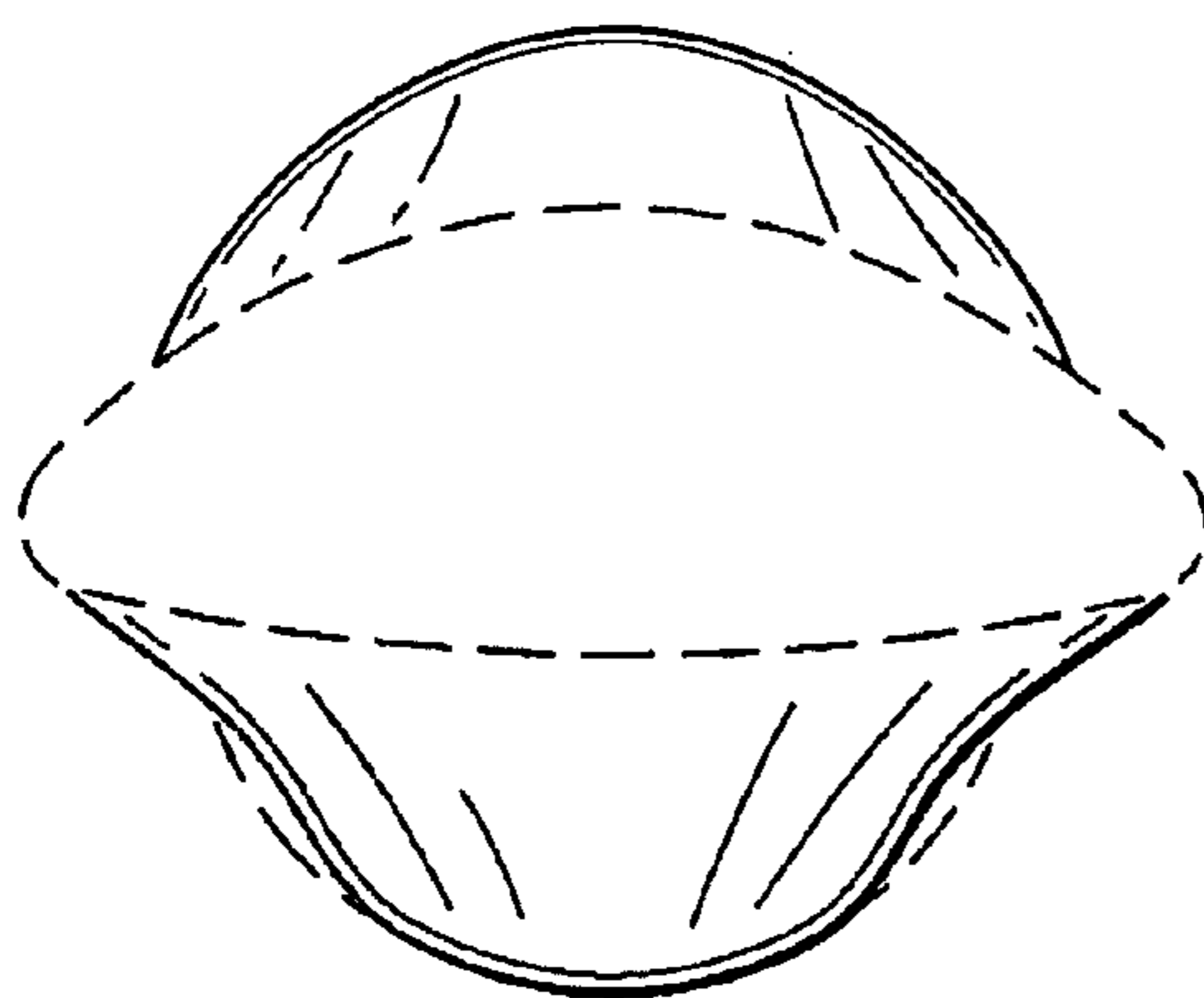

Fig.6.

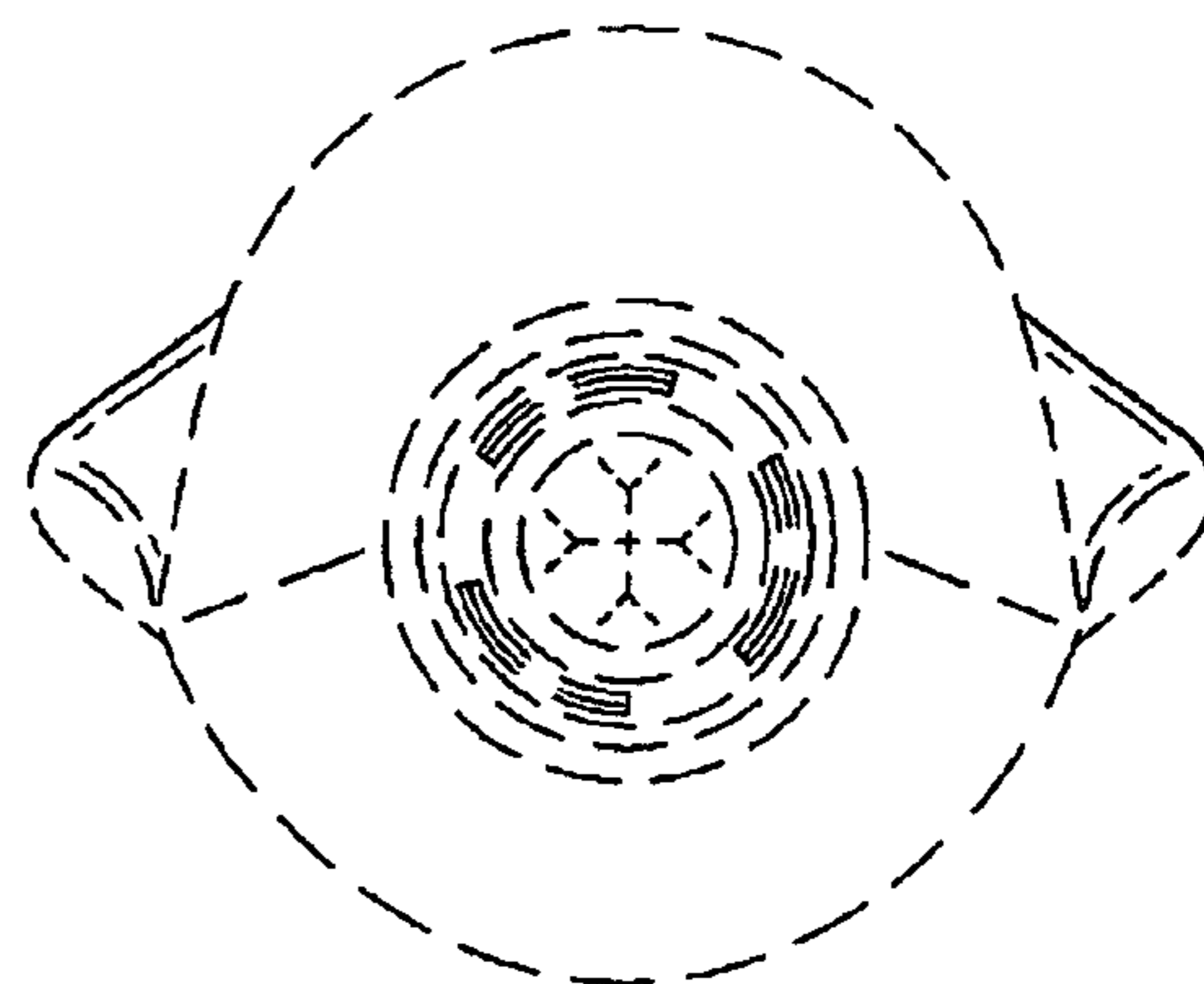

Fig.7.

UNITED STATES PATENT AND TRADEMARK OFFICE
CERTIFICATE OF CORRECTION

PATENT NO. : Des. 585,300 S
APPLICATION NO. : 29/307270
DATED : January 27, 2009
INVENTOR(S) : Domoy et al.

Page 1 of 1

It is certified that error appears in the above-identified patent and that said Letters Patent is hereby corrected as shown below:

Title Page; item (73);

A printing error was found in the above-identified Issued Patent which error was solely committed by the U.S. PTO. This error was found in the Assignee section wherein "Conopco, Inc., Englewood Cliffs, NJ" should have read -- Conopco, Inc., d/b/a Unilever, Englewood Cliffs, NJ --.

Signed and Sealed this

Third Day of March, 2009



JOHN DOLL
Acting Director of the United States Patent and Trademark Office