



US00D585257S

(12) **United States Design Patent**  
**Stratford et al.**

(10) **Patent No.:** **US D585,257 S**  
(45) **Date of Patent:** **\*\* Jan. 27, 2009**

(54) **SANDER**

(75) Inventors: **Mark Stratford**, Darlington (GB);  
**Mark Baxter**, Newcastle upon Tyne  
(GB)

(73) Assignee: **Black & Decker Inc.**, Newark, DE (US)

(\*\*) Term: **14 Years**

(21) Appl. No.: **29/296,362**

(22) Filed: **Oct. 18, 2007**

(30) **Foreign Application Priority Data**

Apr. 23, 2007 (GB) ..... 000711676-0001  
Apr. 23, 2007 (GB) ..... 000711676-0002

(51) **LOC (9) Cl.** ..... **08-01**

(52) **U.S. Cl.** ..... **D8/62**

(58) **Field of Classification Search** ..... D8/67,  
D8/62, 61, 70; D32/15, 17, 19; D4/102;  
451/456, 451, 359, 358, 357, 356, 355, 364,  
451/344

See application file for complete search history.

(56) **References Cited**

**U.S. PATENT DOCUMENTS**

4,410,846 A 10/1983 Gerber et al.  
4,487,270 A 12/1984 Huber  
5,014,793 A 5/1991 Germanton et al.  
5,894,095 A 4/1999 DeMali  
D413,242 S \* 8/1999 Robson ..... D8/62  
D416,459 S \* 11/1999 Pears ..... D8/62  
D435,768 S \* 1/2001 Duffy ..... D8/62  
6,179,696 B1 \* 1/2001 Duffy ..... 451/357  
D447,397 S \* 9/2001 Netzler ..... D8/62  
D494,434 S \* 8/2004 Sun et al. .... D8/62  
D507,731 S \* 7/2005 Robson ..... D8/62  
D509,720 S \* 9/2005 Robson ..... D8/62  
D526,868 S \* 8/2006 Robson ..... D8/62  
7,095,235 B2 8/2006 Fiebig et al.  
D527,594 S \* 9/2006 Wikle ..... D8/62

D527,595 S \* 9/2006 Wikle ..... D8/62  
D528,387 S \* 9/2006 Robson ..... D8/62  
D536,942 S \* 2/2007 Cooper et al. .... D8/62  
7,201,643 B2 \* 4/2007 Dineen et al. .... 451/356  
D548,556 S \* 8/2007 Stratford ..... D8/62  
D555,449 S \* 11/2007 Waldron ..... D8/62  
2006/0003680 A1 \* 1/2006 Robson ..... 451/357

**FOREIGN PATENT DOCUMENTS**

CN 2074697 U 4/1991

(Continued)

*Primary Examiner*—Cathron Brooks  
*Assistant Examiner*—Austin Murphy  
(74) *Attorney, Agent, or Firm*—Bruce S. Shapiro; John Yun;  
Wesley W. Muller

(57) **CLAIM**

The ornamental design for a sander, as shown and described.

**DESCRIPTION**

FIG. 1 is a right/front perspective view of a sander.  
FIG. 2 is a front view thereof.  
FIG. 3 is a rear view thereof.  
FIG. 4 is a right side view thereof.  
FIG. 5 is a left side view thereof.  
FIG. 6 is a top view thereof.  
FIG. 7 is a bottom view thereof.  
FIG. 8 is a right/front perspective view of a sander.  
FIG. 9 is a front view thereof.  
FIG. 10 is a rear view thereof.  
FIG. 11 is a right side view thereof.  
FIG. 12 is a left side view thereof.  
FIG. 13 is a top view thereof; and,  
FIG. 14 is a bottom view thereof.

**1 Claim, 12 Drawing Sheets**

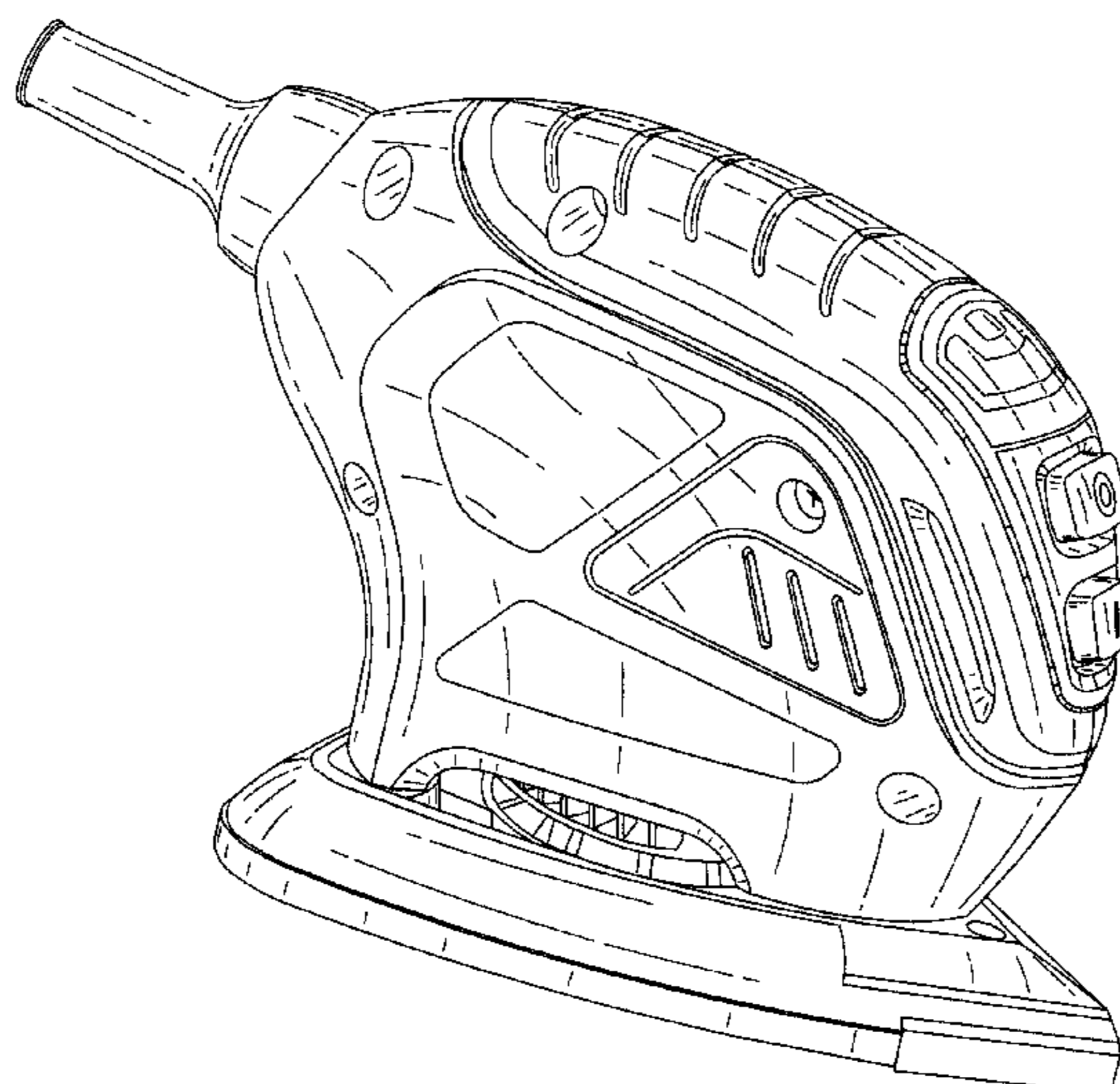

# US D585,257 S

Page 2

---

FOREIGN PATENT DOCUMENTS					
			EM	00041165-0005	3/2004
			EM	000143912-0001	6/2004
			EM	000212659-0001	11/2004
			EM	000251269	2/2005
			EM	000430459-0001	12/2005
			EM	000432976-0006	12/2005
			EP	0659525	6/1995
			EP	04802793.2	4/2007
			JP	10286772	10/1998
			WO	2005070624	8/2005
			* cited by examiner		
DE	M9605182	12/1996			
DE	M9609736	6/1997			
DE	49807106	5/1999			
DE	49905194	9/1999			
DE	40304850	12/2003			
DE	40306895.9	4/2004			
DE	40403888.8	1/2005			
DE	102004003203.3	8/2005			
DE	40500733.7	10/2005			
DE	40501033.8	10/2005			

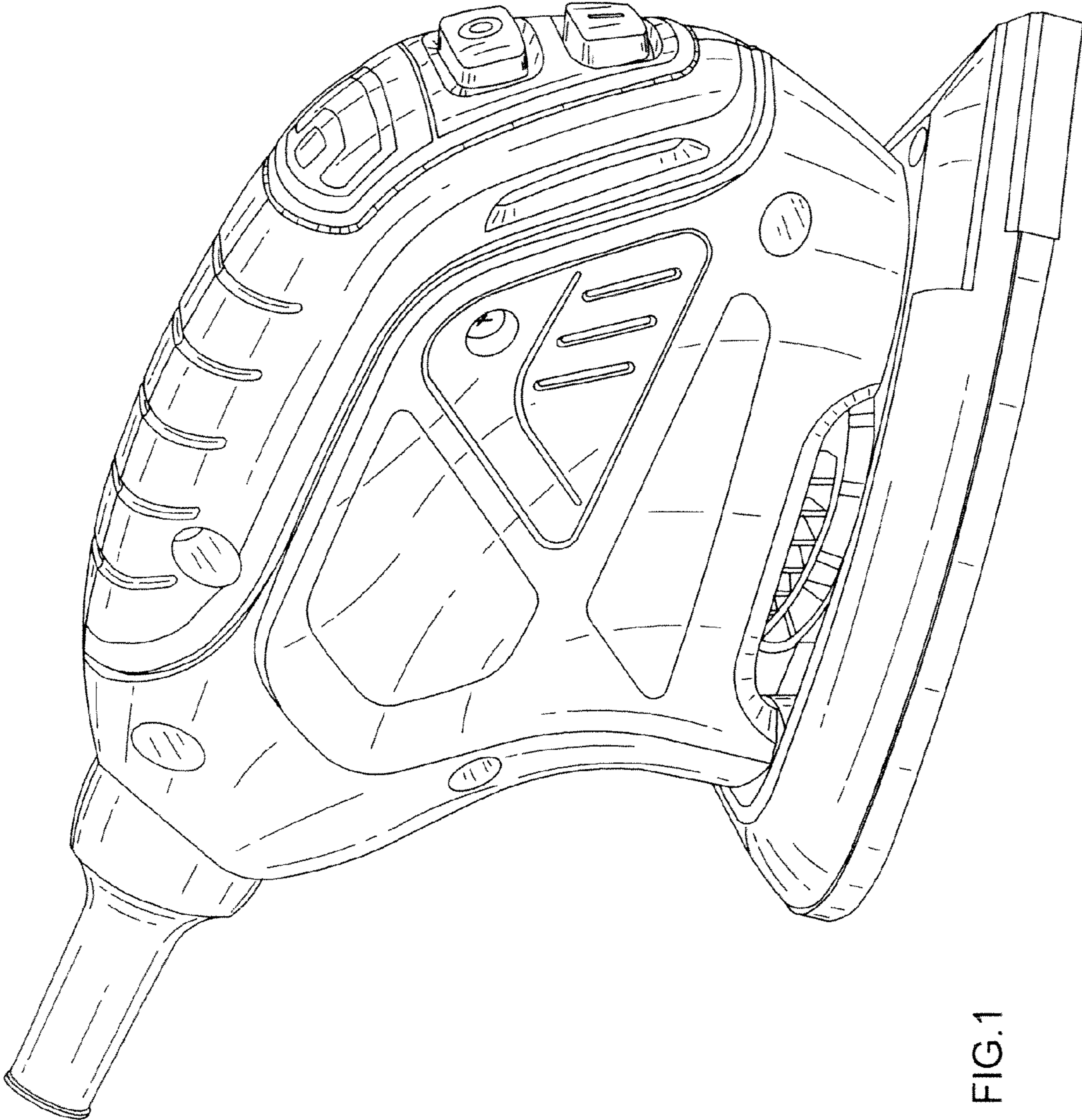

FIG.1

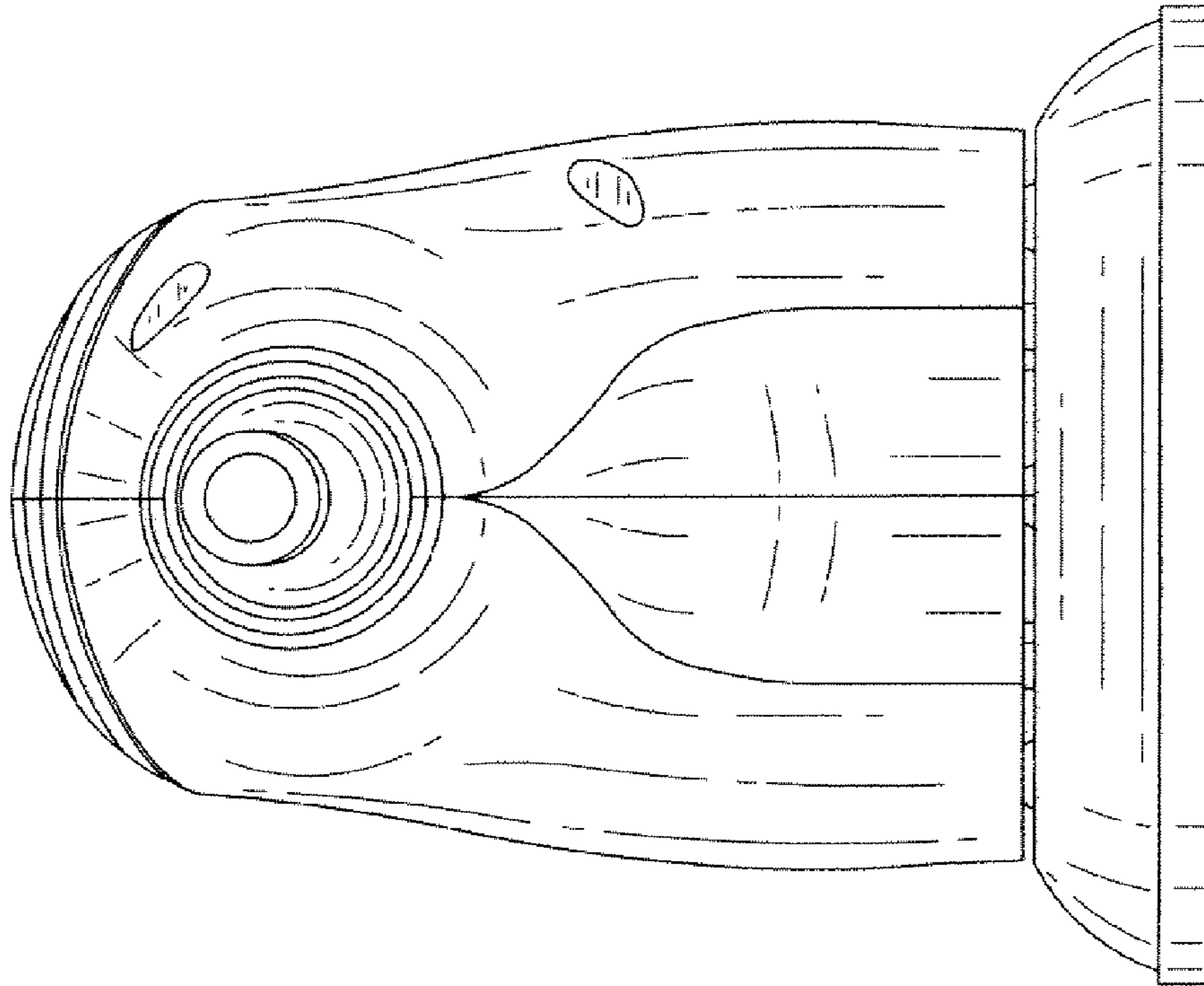

FIG. 2

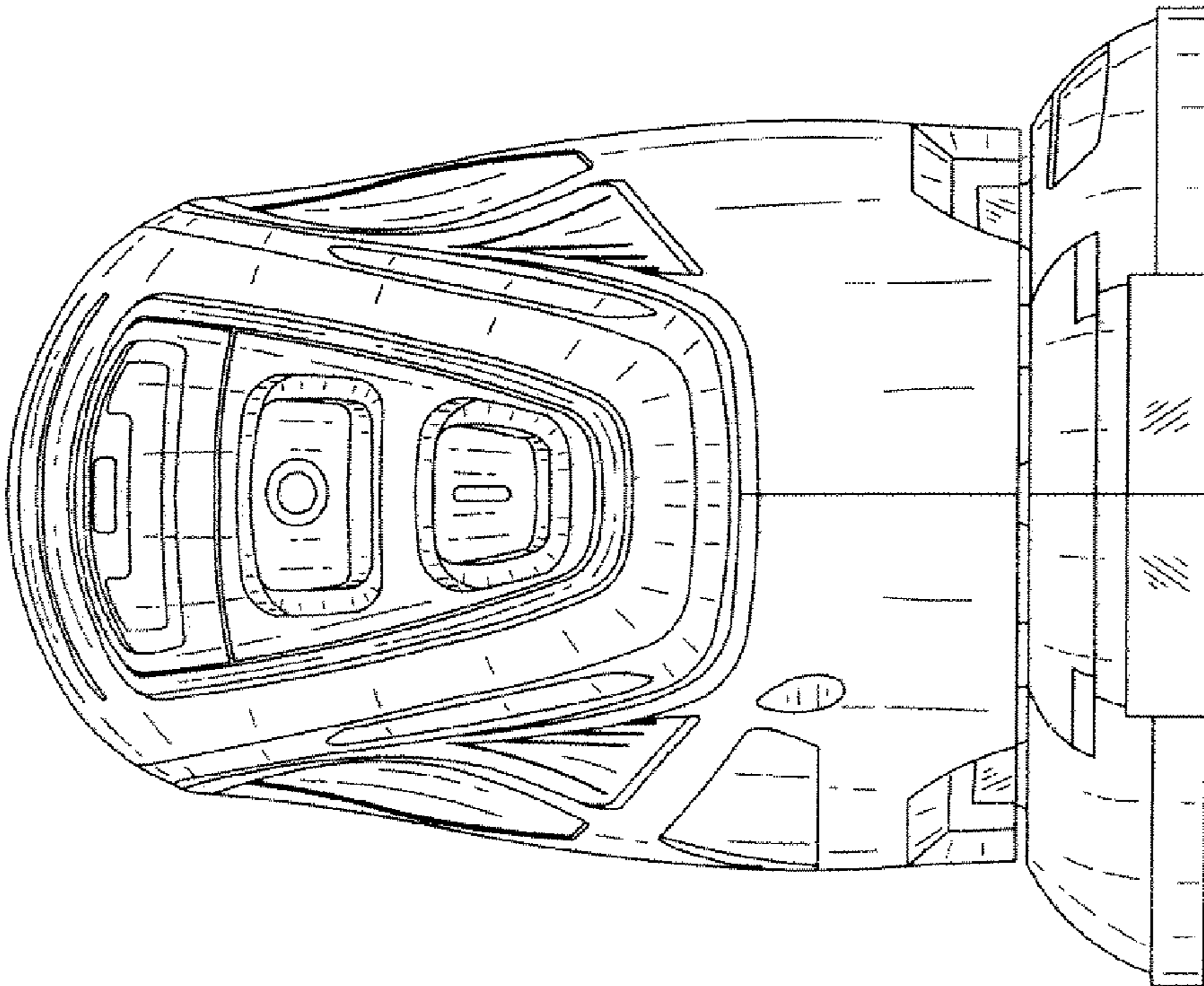

FIG. 3

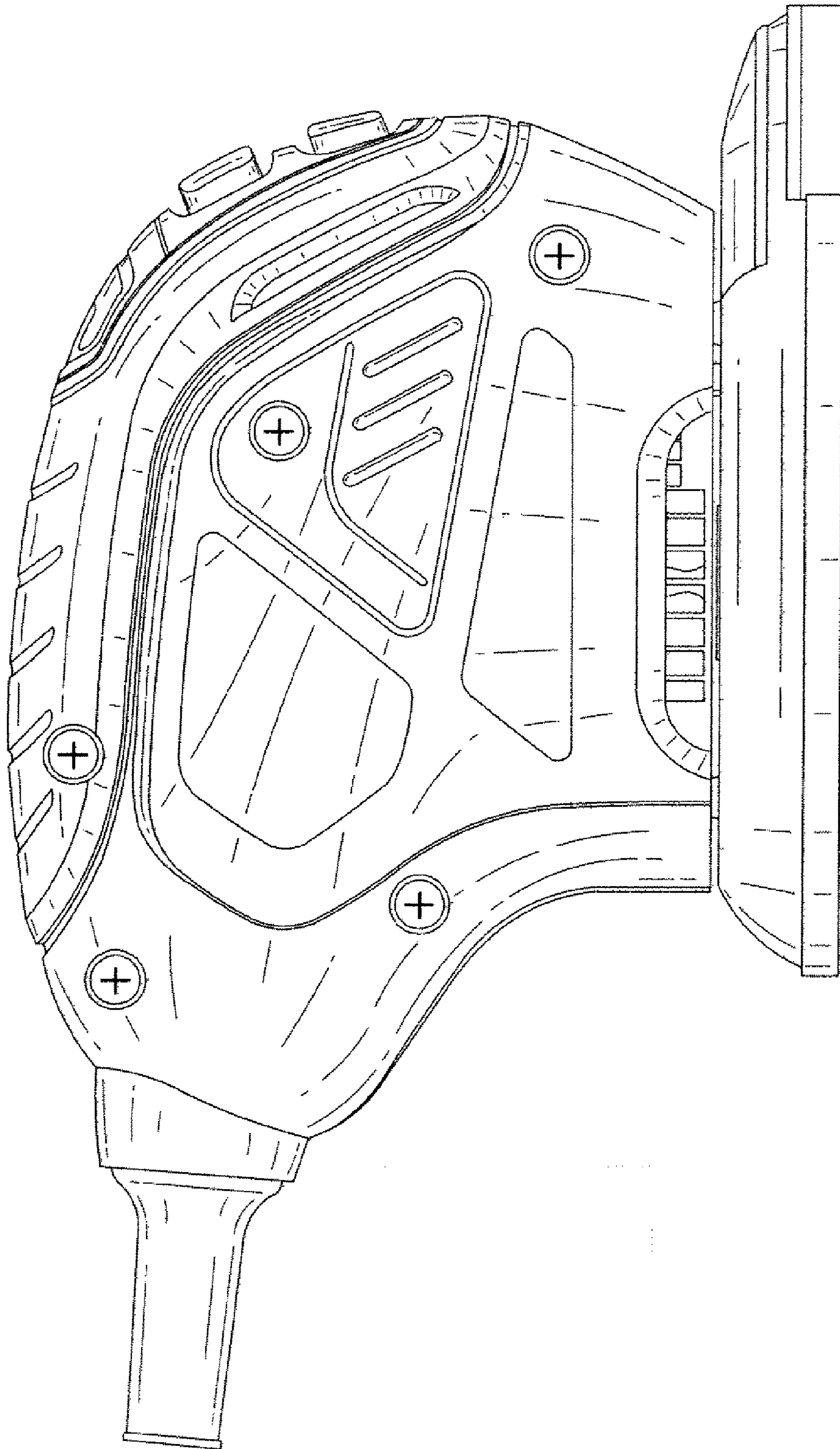

FIG. 4

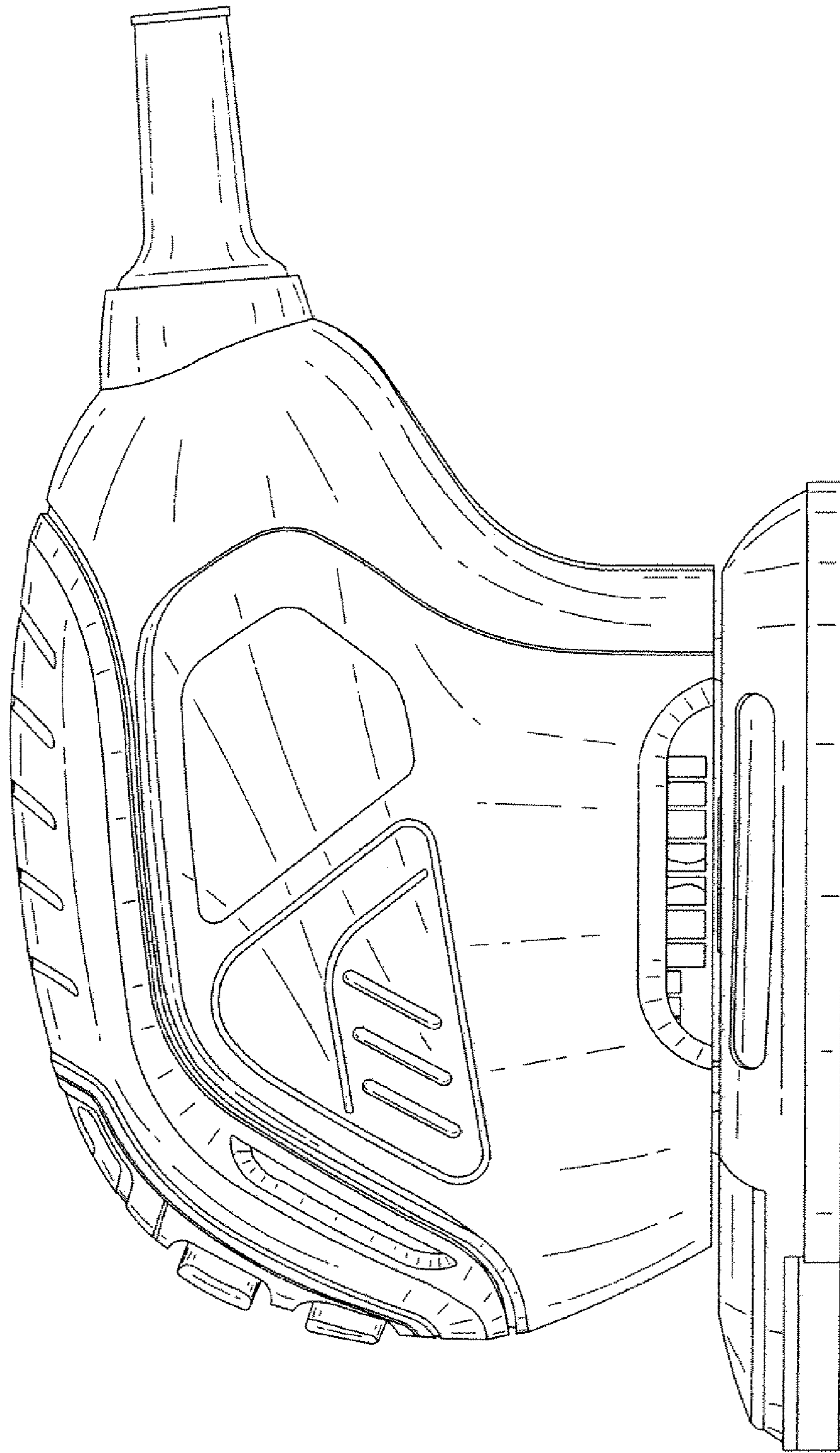

FIG. 5

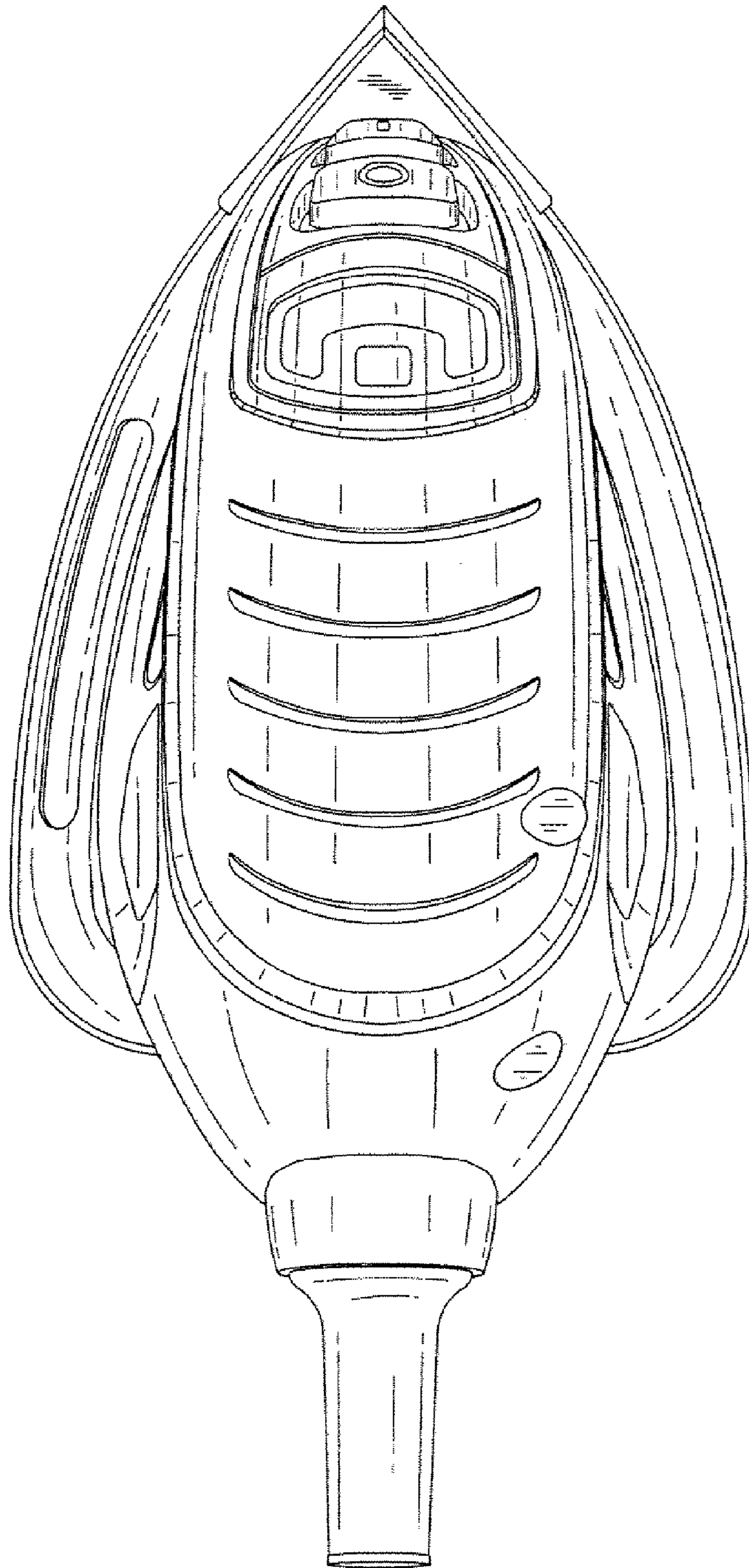

FIG. 6

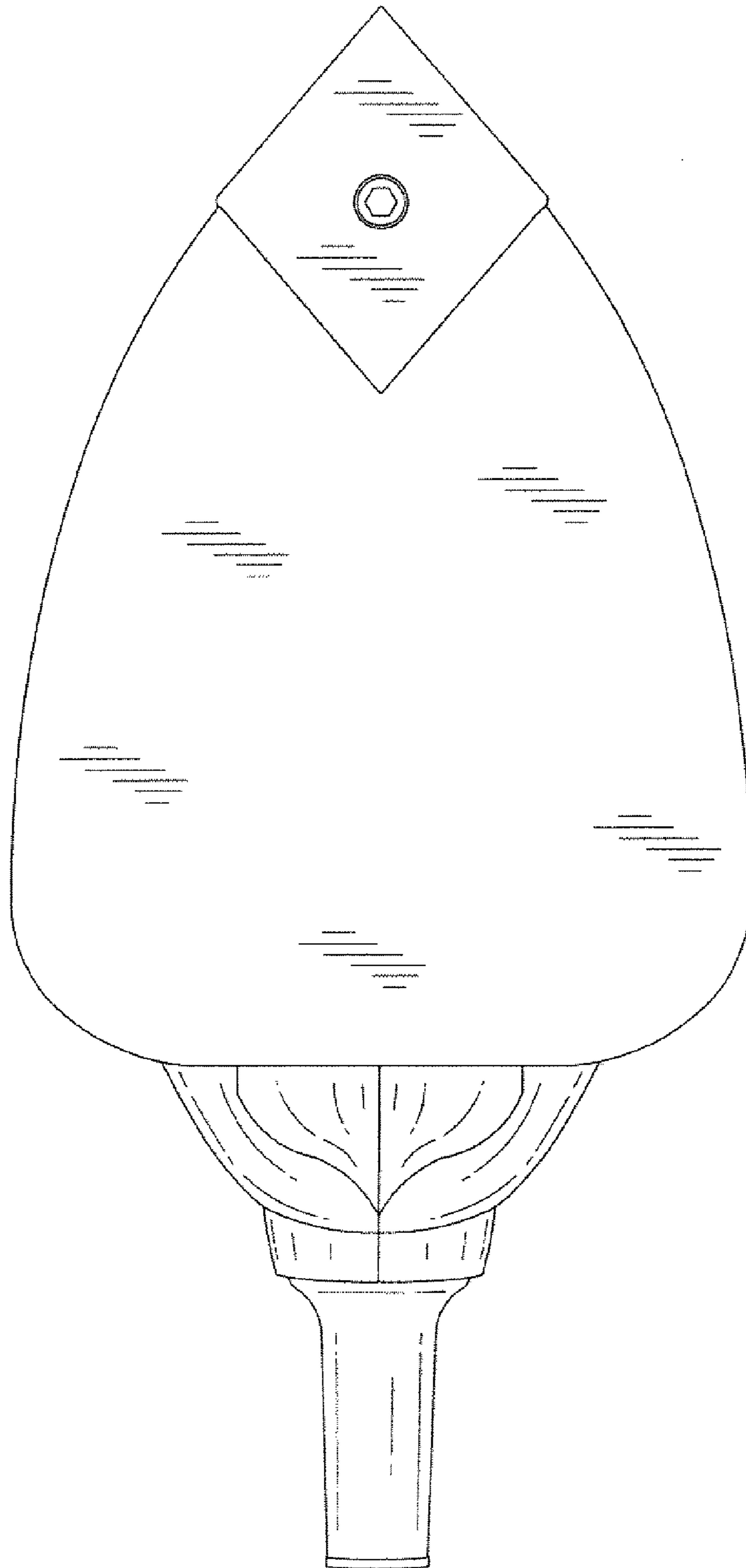

FIG. 7



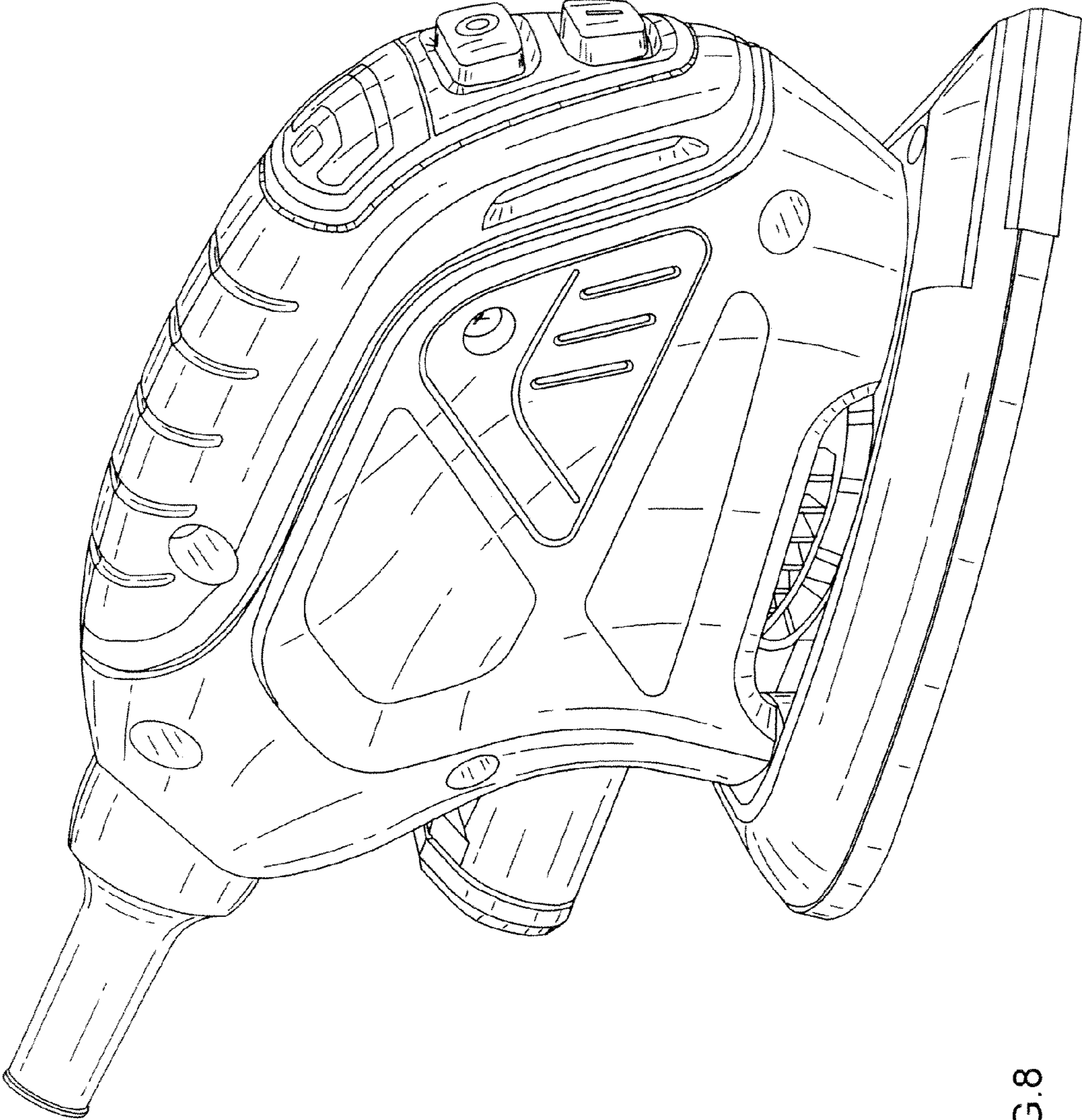

FIG.8

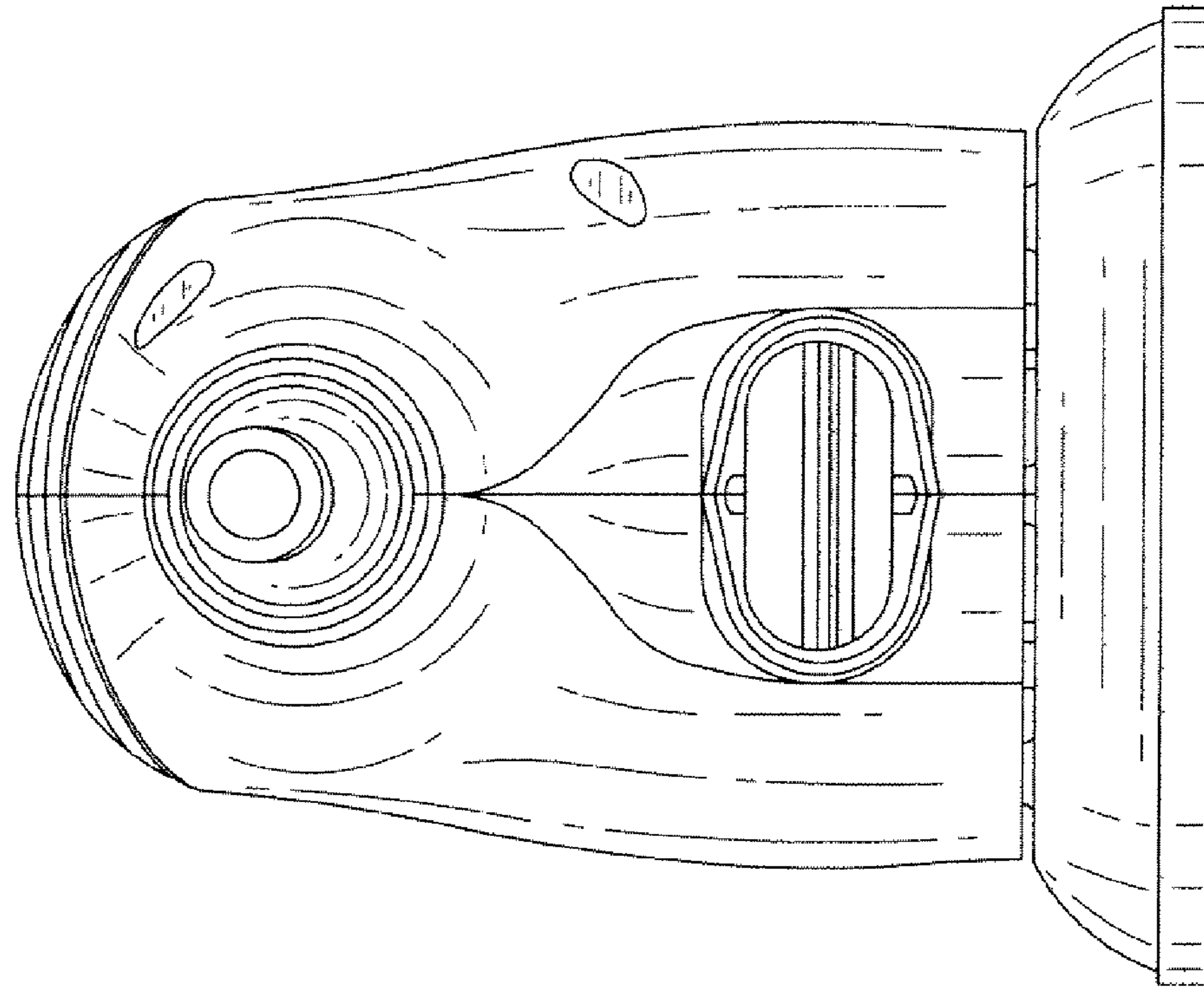

FIG. 9

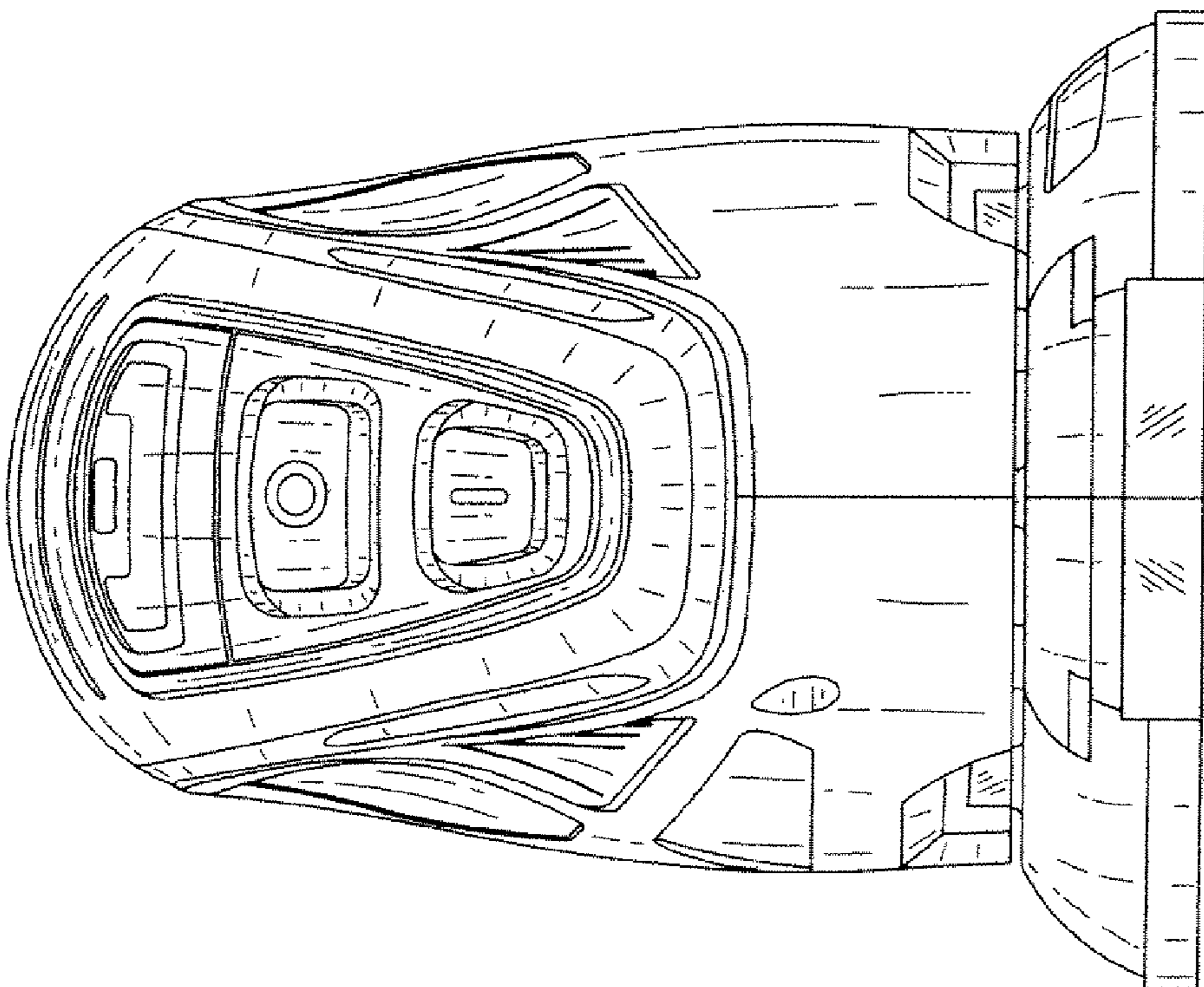

FIG. 10

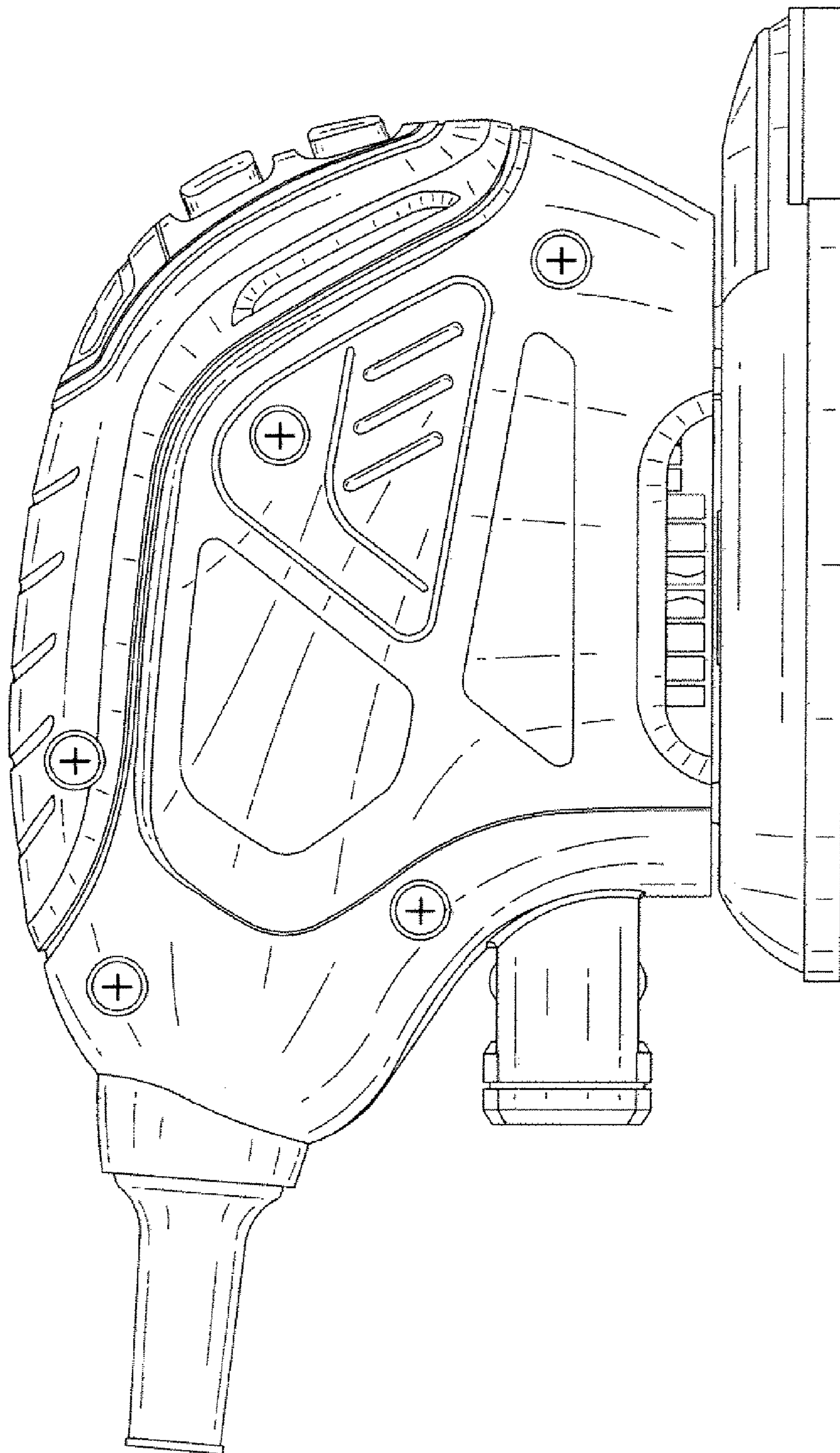

FIG. 11

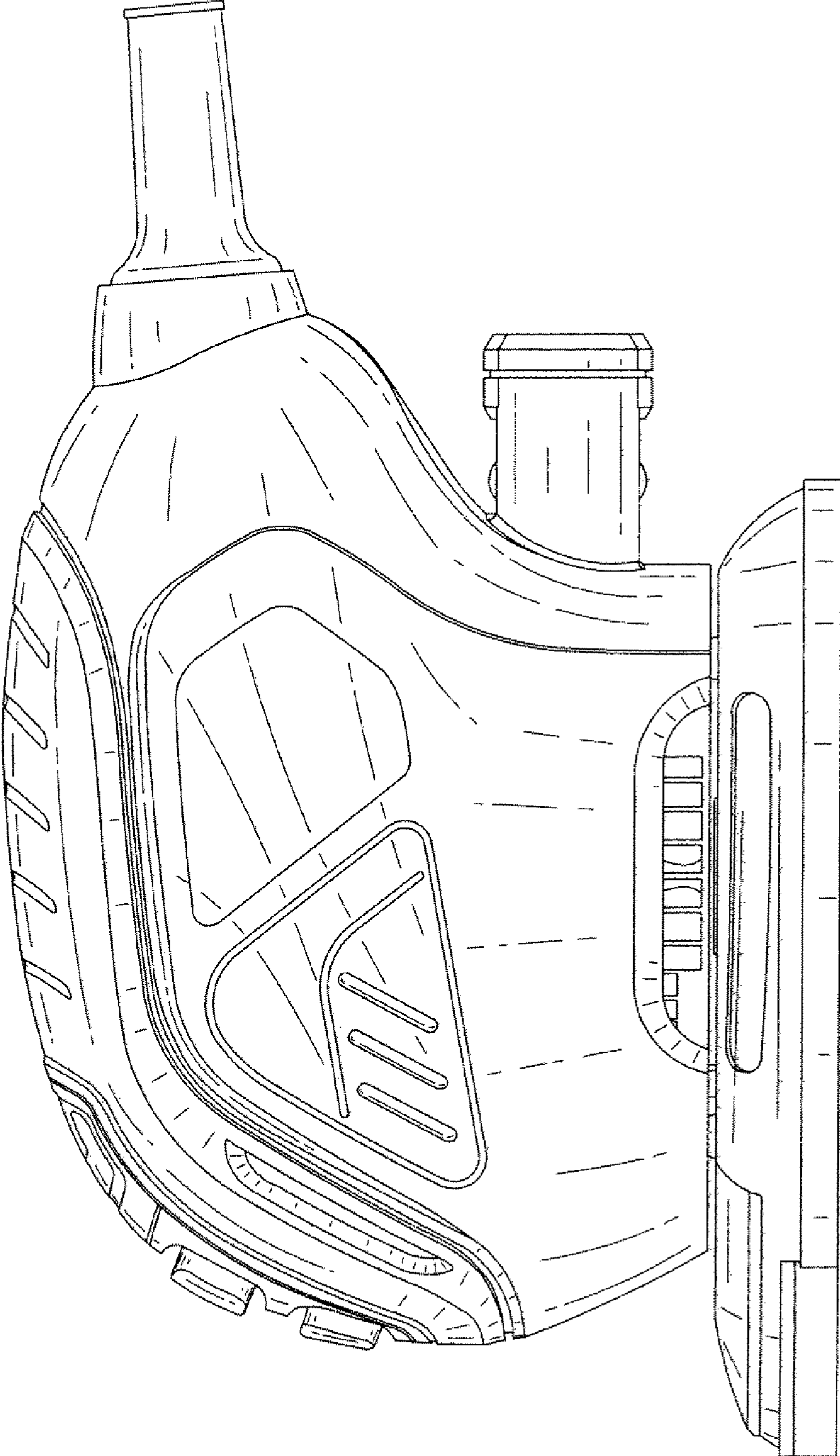

FIG. 12

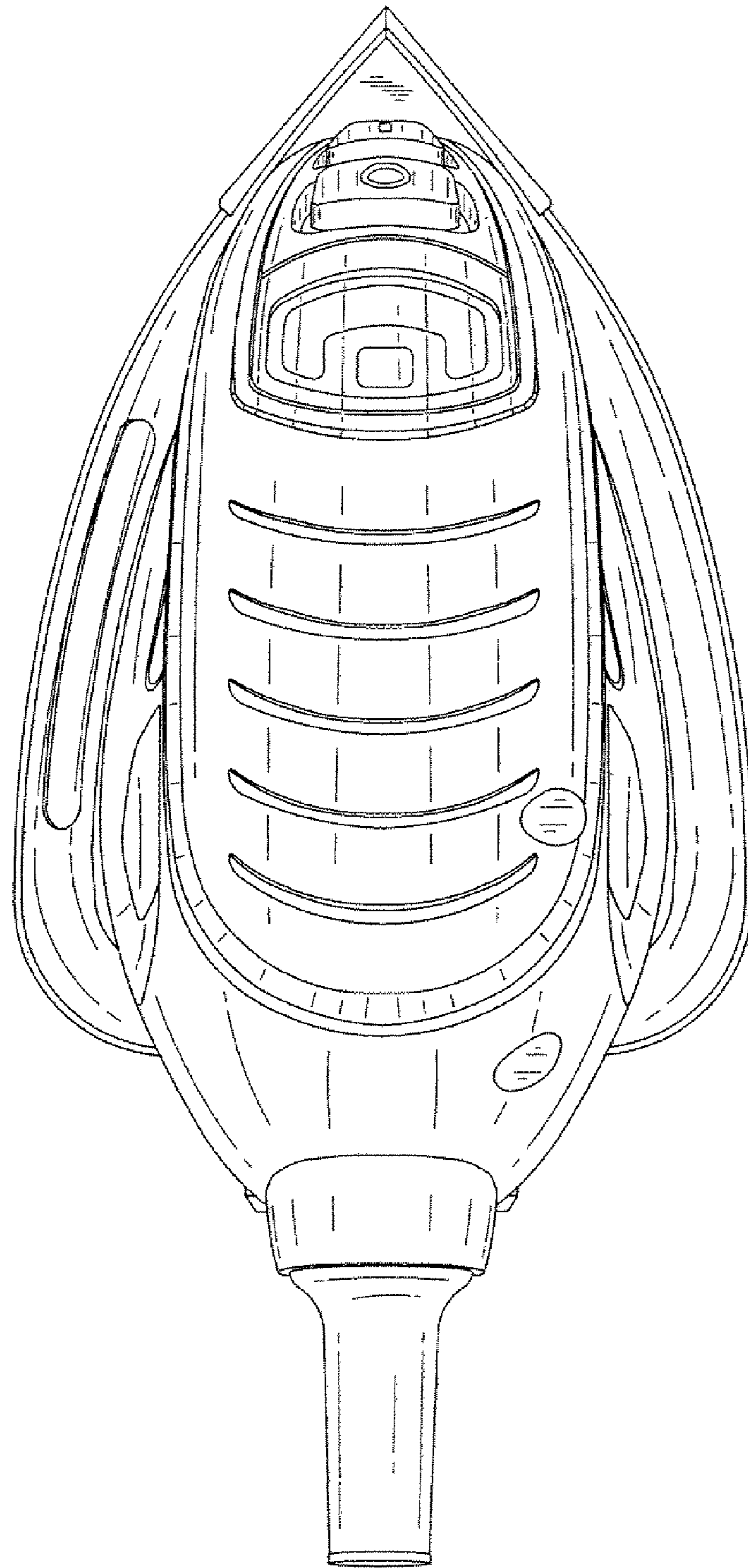

FIG. 13

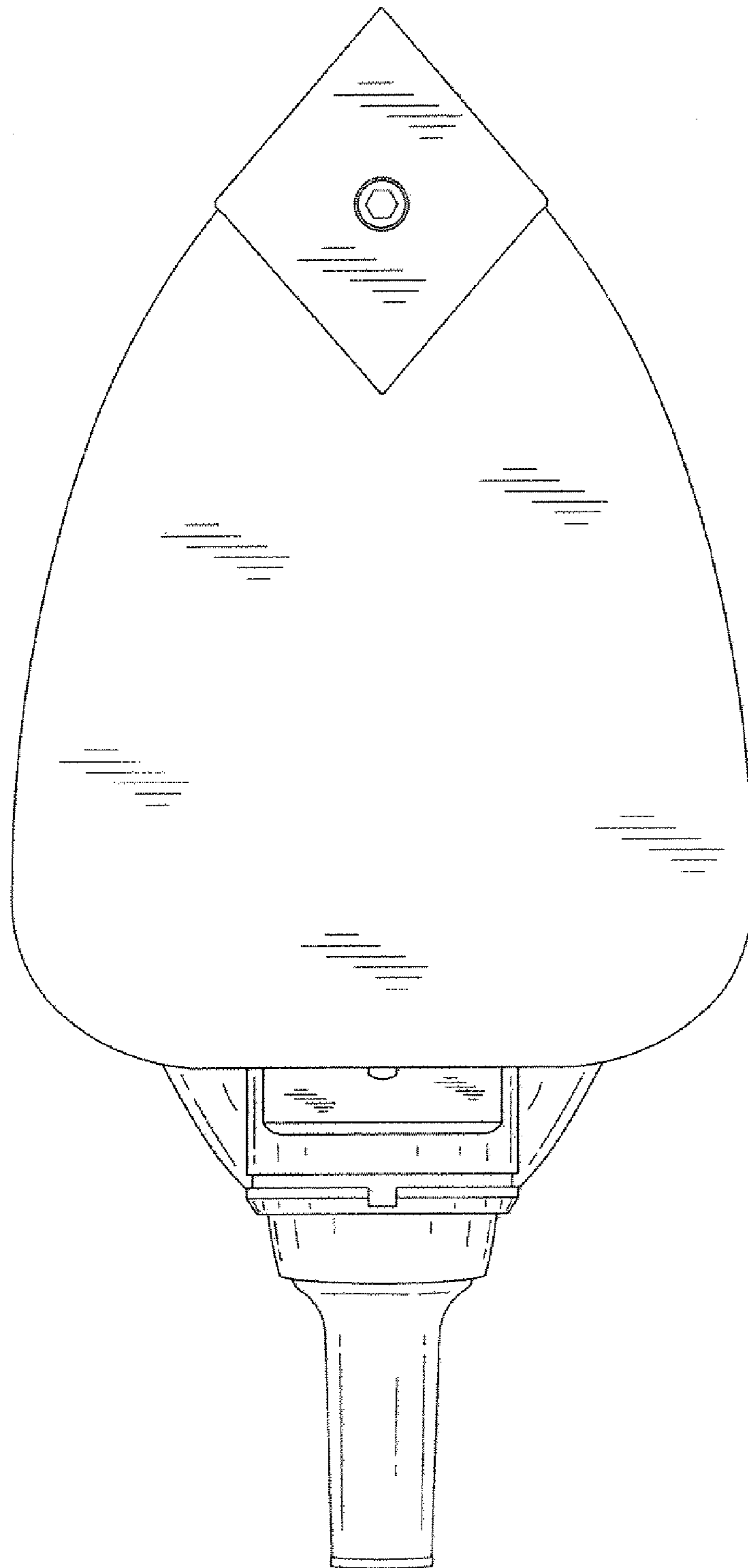

FIG. 14