



US00D585193S

(12) **United States Design Patent**
Gonzalez

(10) **Patent No.:** **US D585,193 S**
(45) **Date of Patent:** **** Jan. 27, 2009**

(54) **HANDBAG**

(75) Inventor: **Alvaro Gonzalez**, Florence (IT)

(73) Assignee: **J. Choo Limited**, London (GB)

(**) Term: **14 Years**

(21) Appl. No.: **29/294,436**

(22) Filed: **Jan. 9, 2008**

(30) **Foreign Application Priority Data**

Jul. 11, 2007 (EM) 000758420-0010

(51) **LOC (9) Cl.** **03-01**

(52) **U.S. Cl.** **D3/245**

(58) **Field of Classification Search** D3/232–233,
D3/240–246, 318, 322, 324; 150/100, 103–104,
150/107–110, 114, 118–119

See application file for complete search history.

(56) **References Cited**

U.S. PATENT DOCUMENTS

- D280,866 S * 10/1985 Bomes et al. D3/287
- D380,087 S * 6/1997 Roth D3/243
- D520,743 S 5/2006 Gonzalez
- D522,238 S * 6/2006 Stulman D3/243
- D534,352 S * 1/2007 Delafontaine D3/246
- D535,475 S * 1/2007 Delafontaine D3/246
- D555,898 S * 11/2007 Morelli D3/232
- D560,909 S 2/2008 Gerbi

OTHER PUBLICATIONS

U.S. Appl. No. 29/269,617, filed Dec. 4, 2006, First Named Inventor: Alvaro Gonzalez.

* cited by examiner

Primary Examiner—Holly H Baynham

(74) *Attorney, Agent, or Firm*—Fross Zelnick Lehrman & Zissu, P.C.; Lawrence E. Apolzon, Esq.

(57) **CLAIM**

The ornamental design for a handbag, as shown and described.

DESCRIPTION

FIG. 1 is a front perspective view of a handbag showing my new design, in an open position;

FIG. 2 is a front view of the handbag shown in FIG. 1, in an open position;

FIG. 3 is a rear view of the handbag shown in FIG. 1, in an open position;

FIG. 4 is a left side view of the handbag shown in FIG. 1, in an open position;

FIG. 5 is a right side view of the handbag shown in FIG. 1, in an open position;

FIG. 6 is a top view of the handbag shown in FIG. 1, in an open position;

FIG. 7 is a bottom view of the handbag shown in FIG. 1, in an open position;

FIG. 8 is a front perspective view of the handbag shown in FIG. 1 folded into a smaller pouch shown on the left of the handbag shown in FIG. 1.

FIG. 9 is a front view of the handbag shown in FIG. 8, folded into a smaller pouch;

FIG. 10 is a rear view of the handbag shown in FIG. 8, folded into a smaller pouch;

FIG. 11 is a left side view of the handbag shown in FIG. 8, folded into a smaller pouch;

FIG. 12 is a right side view of the handbag shown in FIG. 8, folded into a smaller pouch;

FIG. 13 is a top view of the handbag shown in FIG. 8, folded into a smaller pouch; and,

FIG. 14 is a bottom view of the handbag shown in FIG. 8, folded into a smaller pouch.

The broken line showing of the zippers, zipper pulls, race-track logo, handles, rivets, and metal rings is for illustrative purposes only and forms no part of the claimed design.

1 Claim, 14 Drawing Sheets





FIG. 1

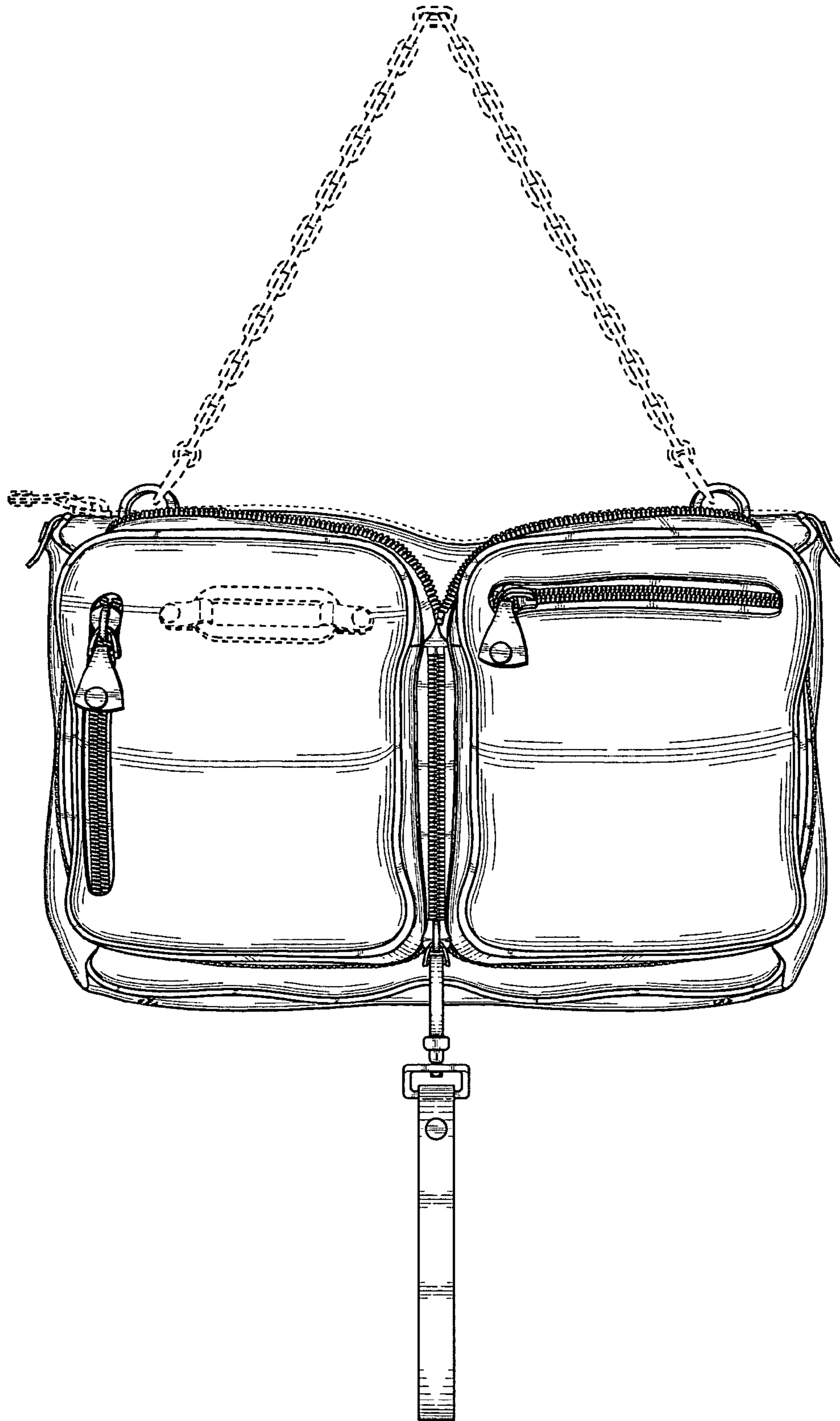

FIG. 2



FIG. 3

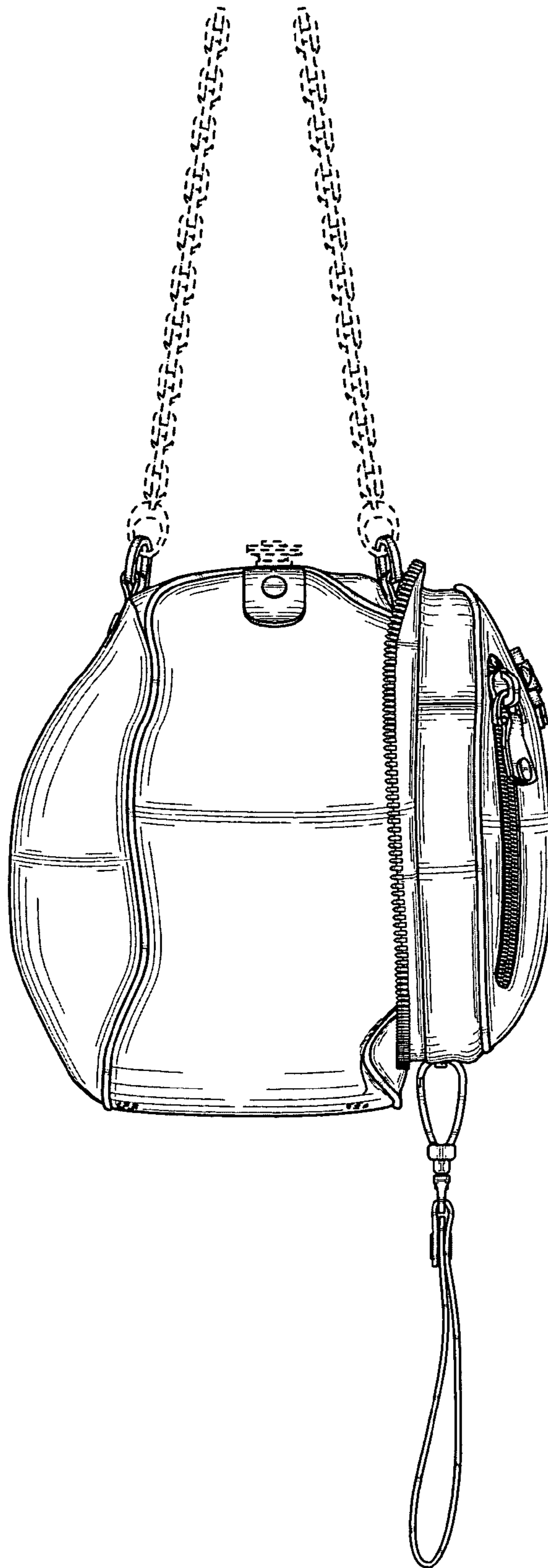

FIG. 4

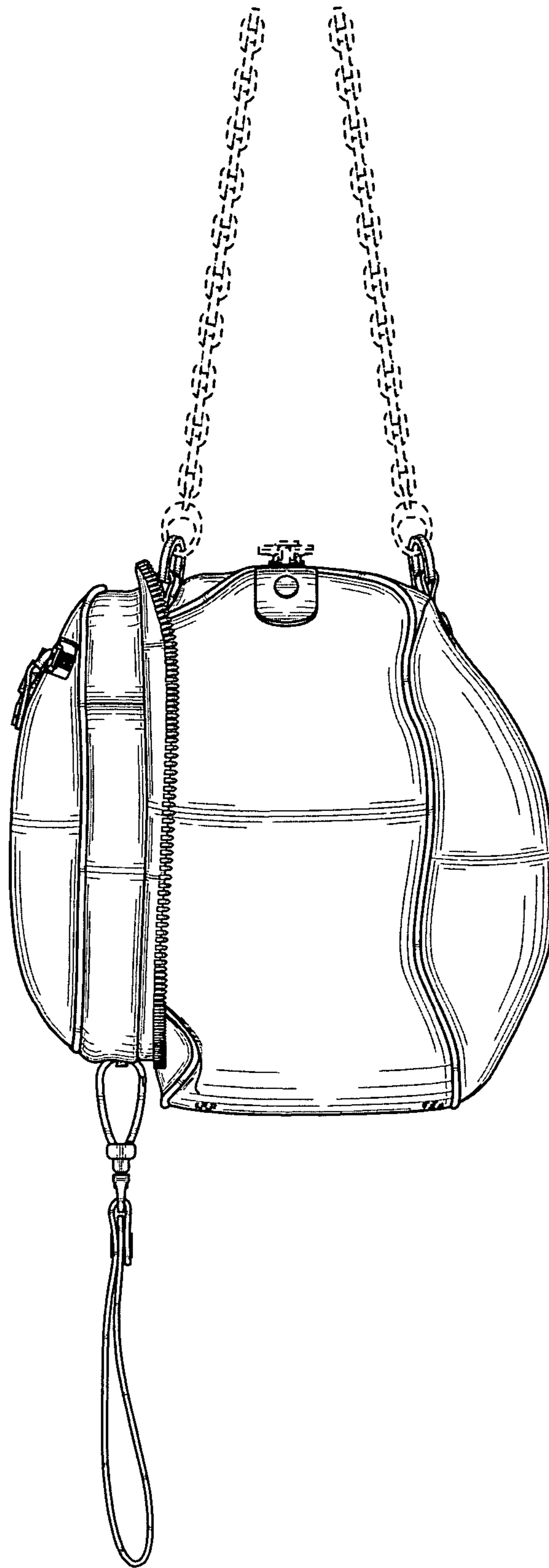

FIG. 5

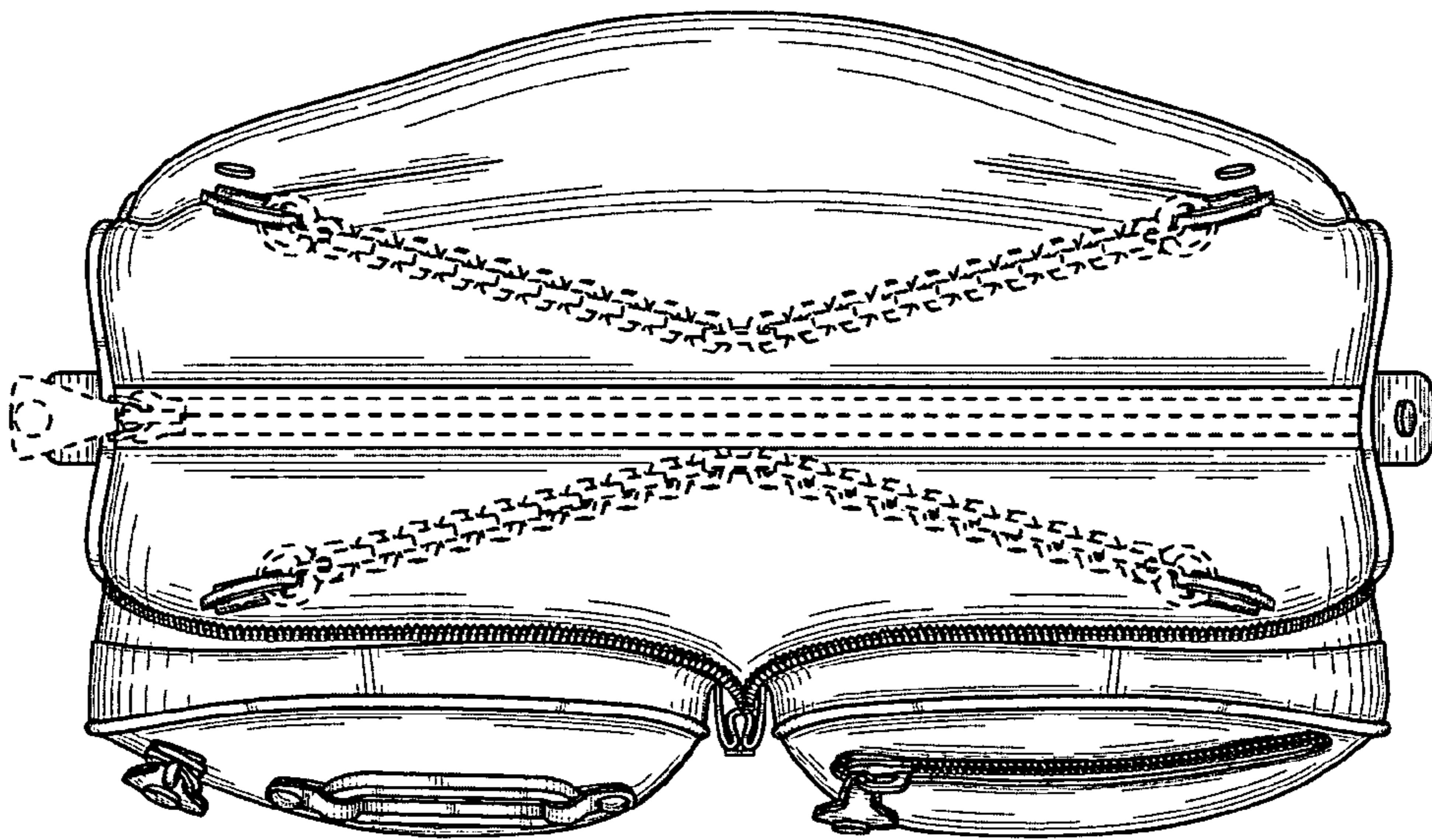

FIG. 6

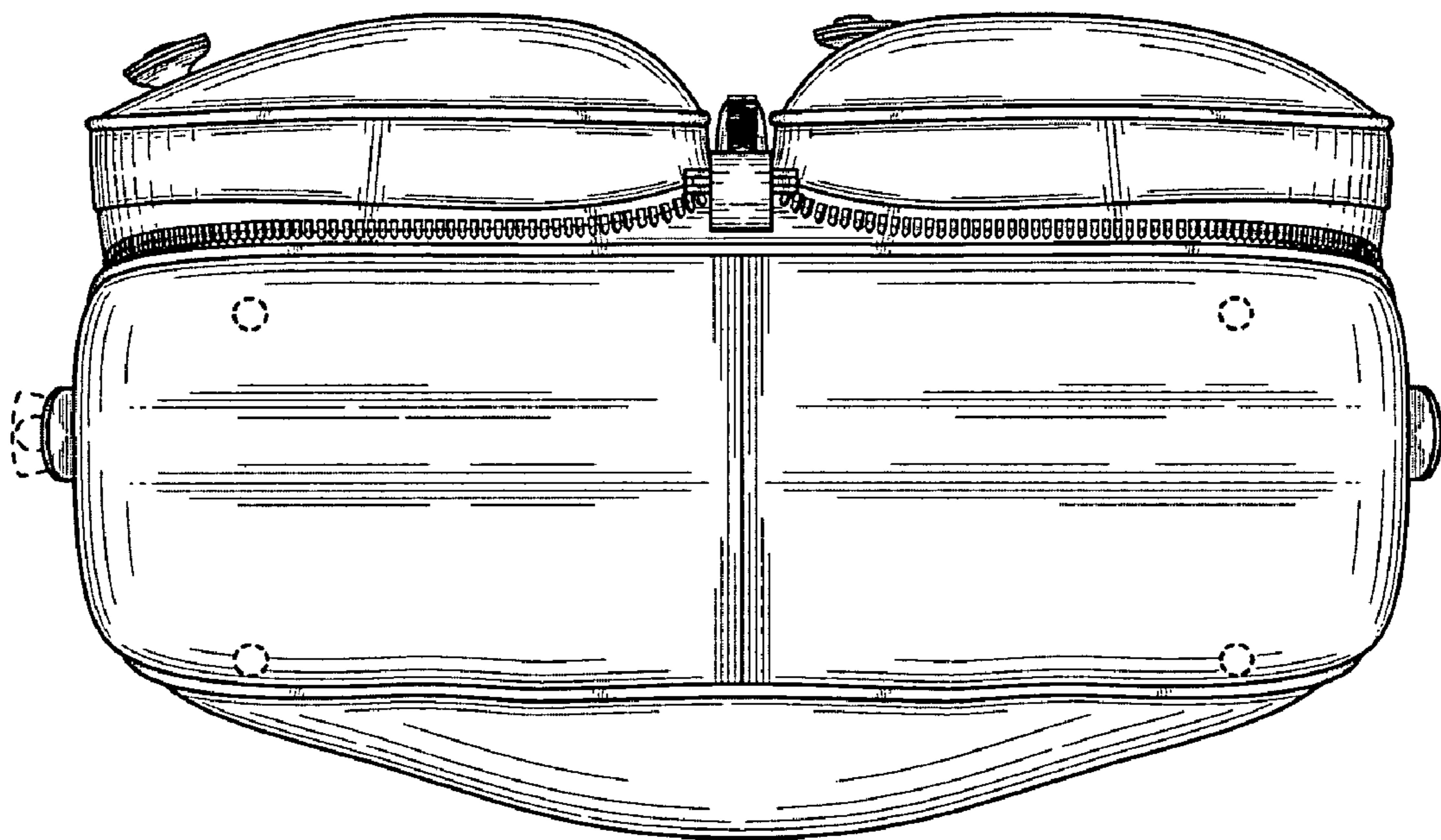

FIG. 7

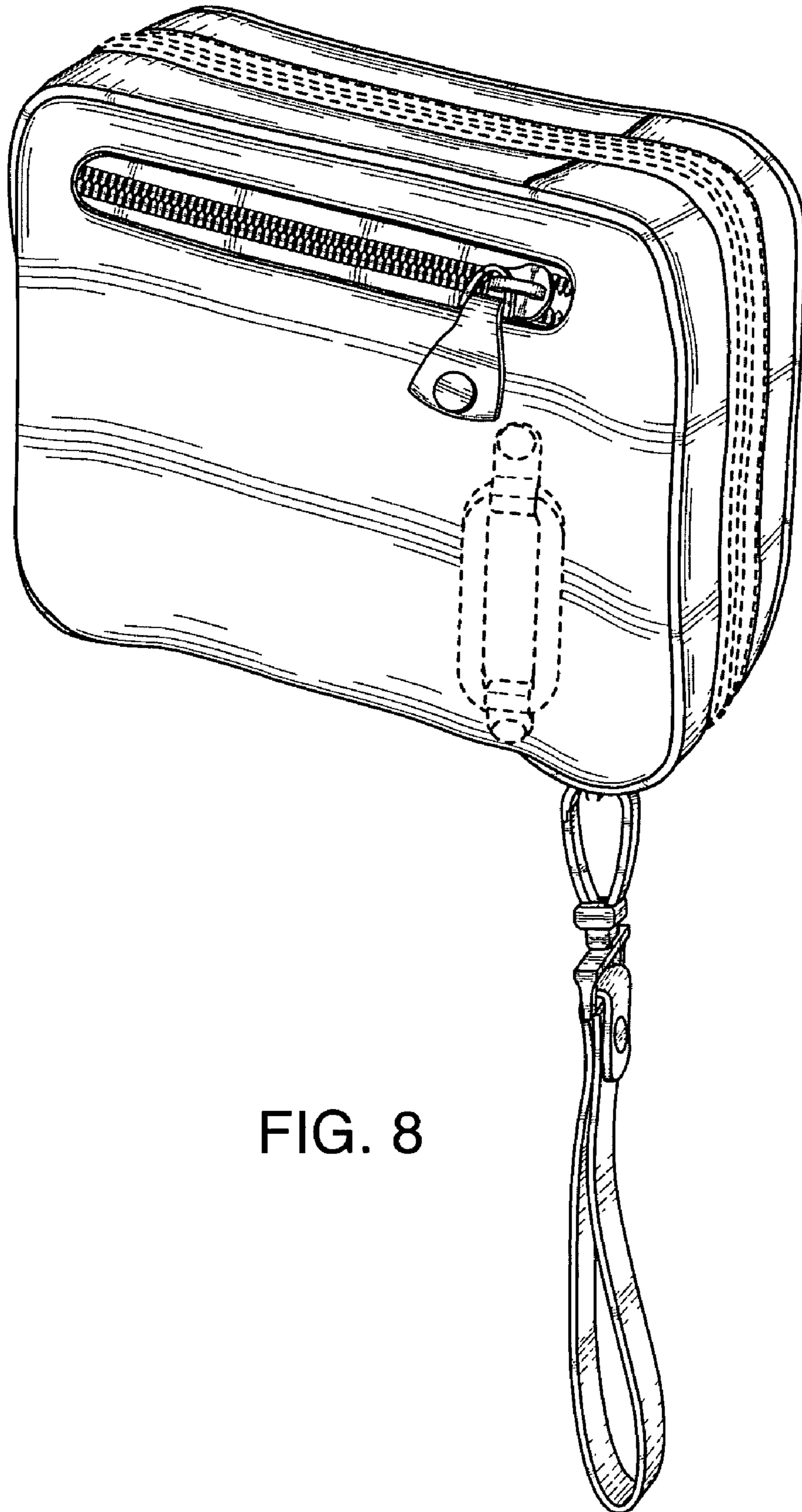

FIG. 8

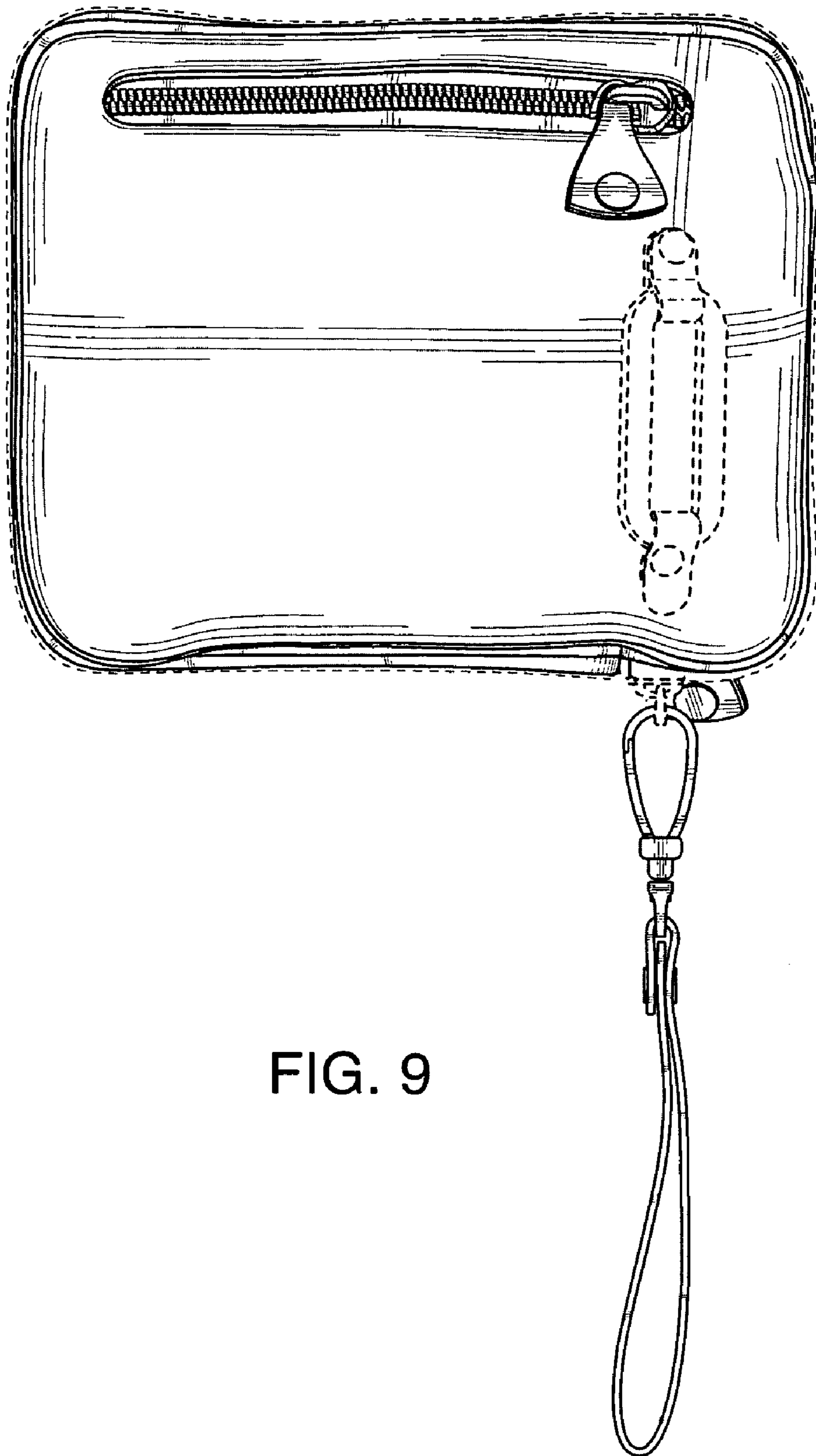

FIG. 9

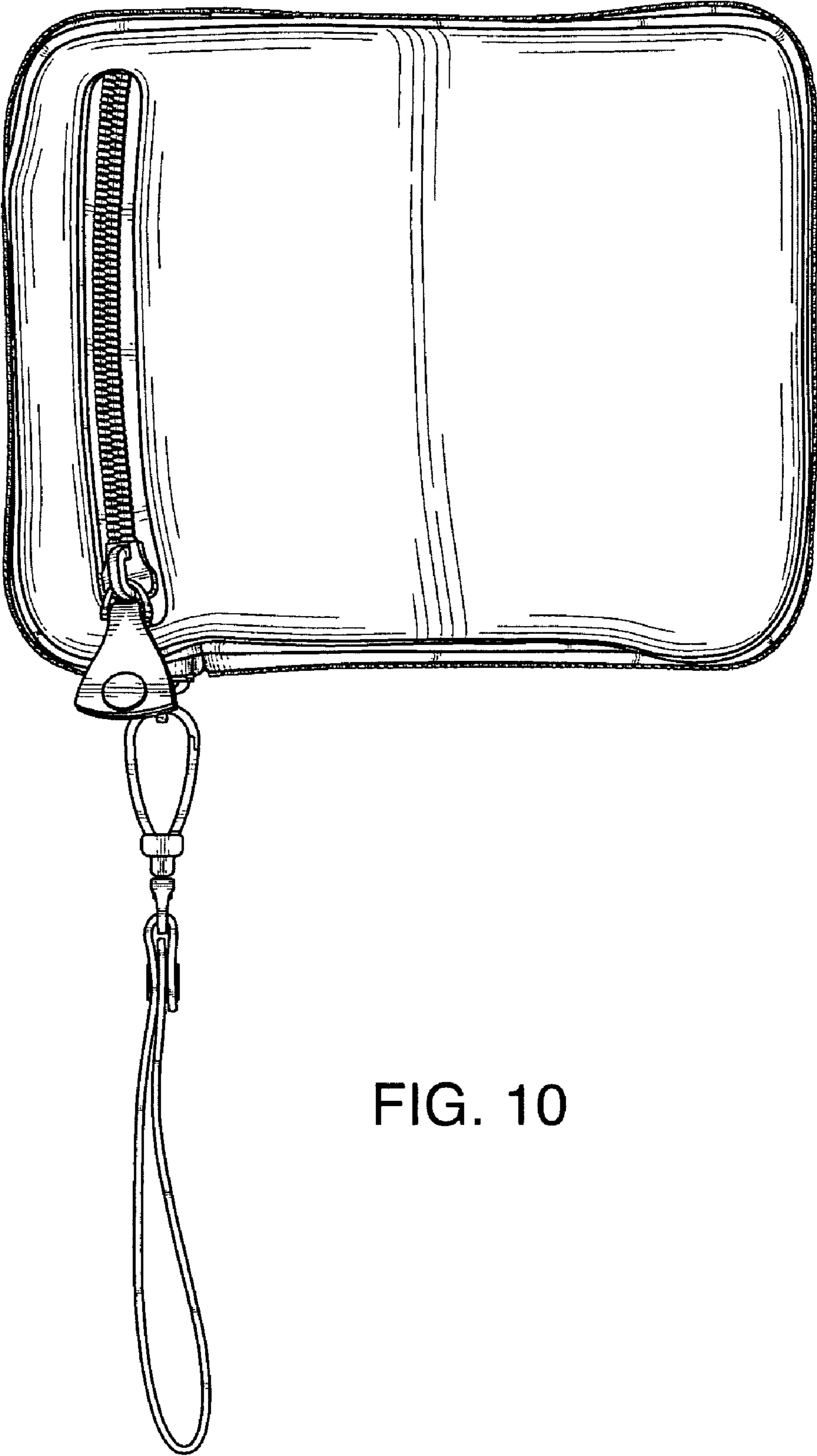

FIG. 10

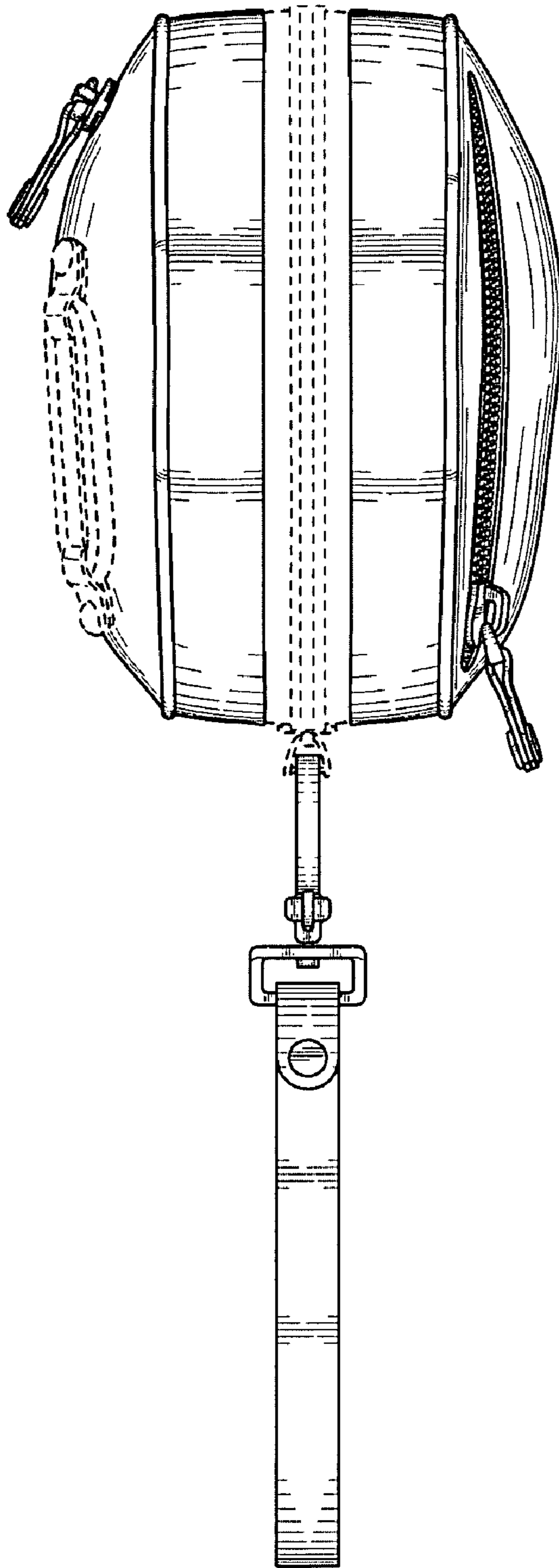

FIG. 11

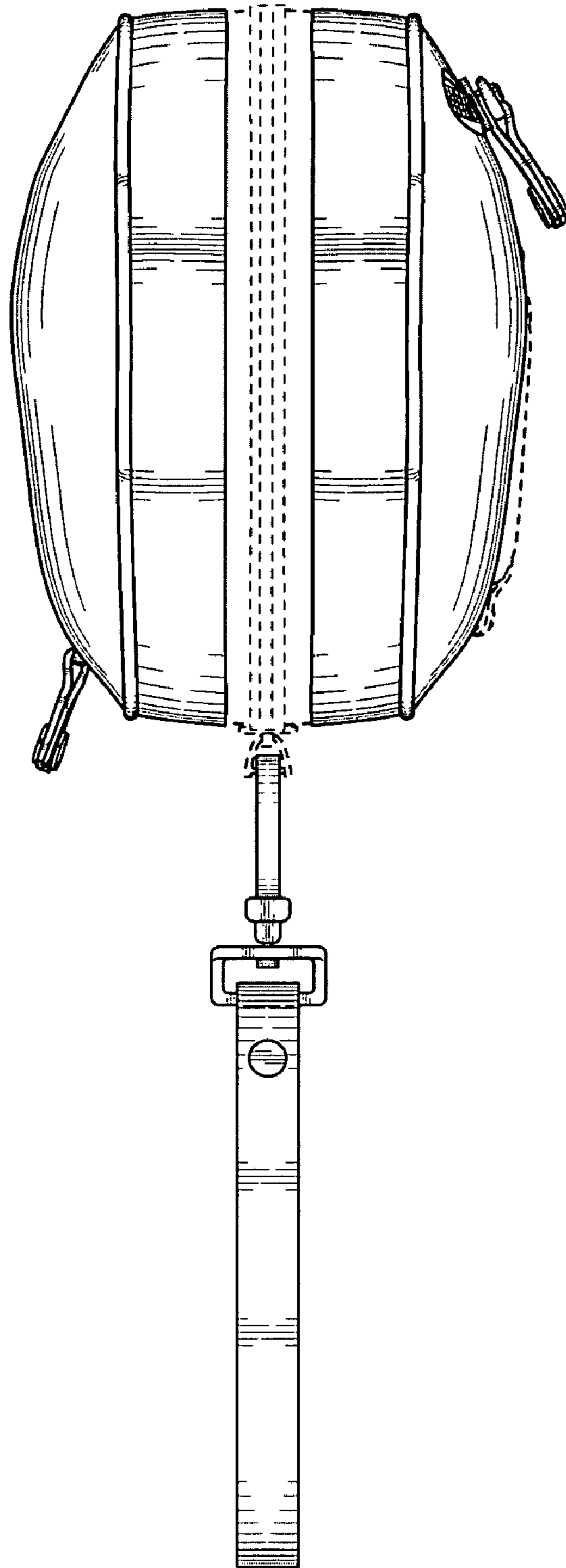

FIG. 12

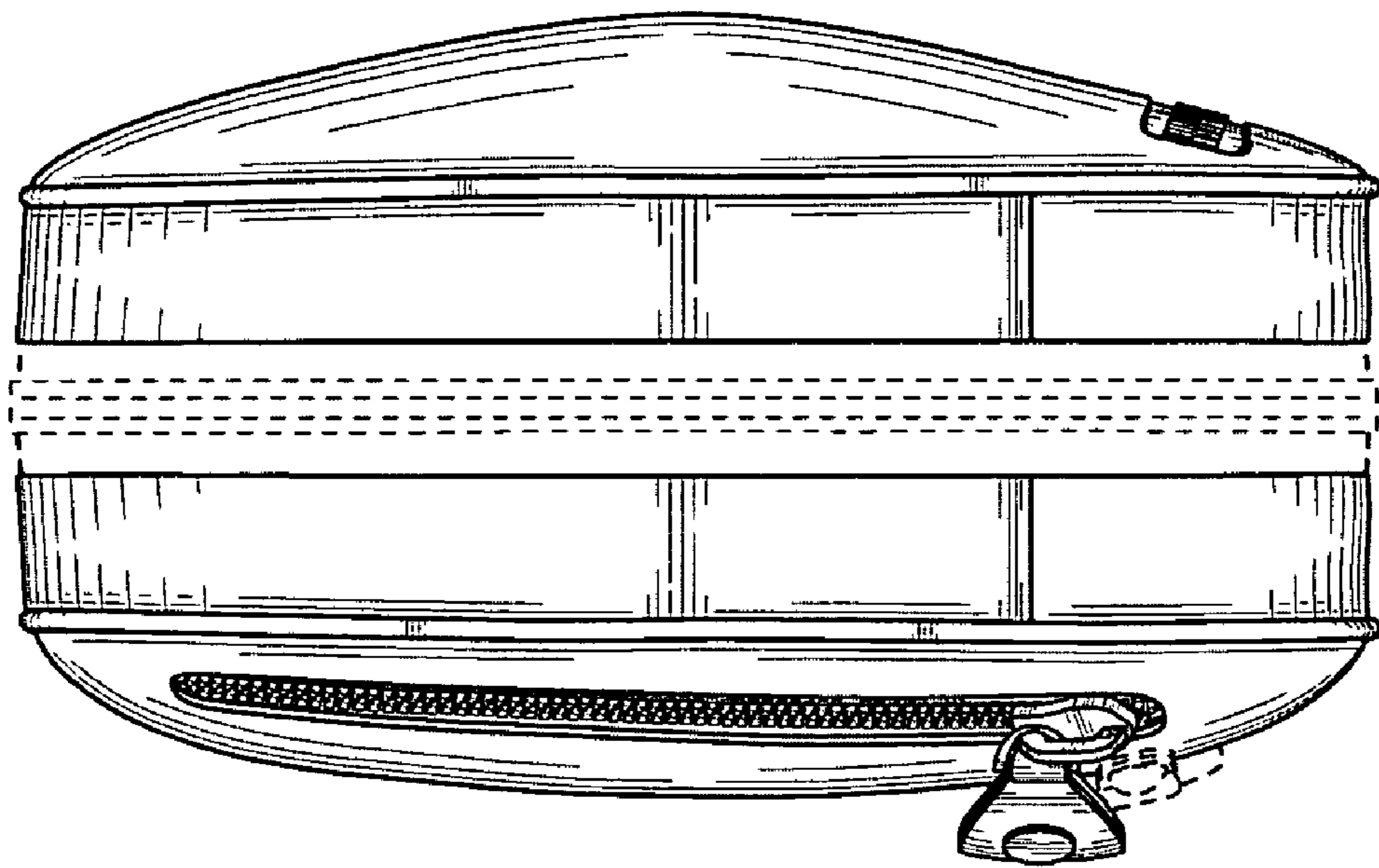

FIG. 13

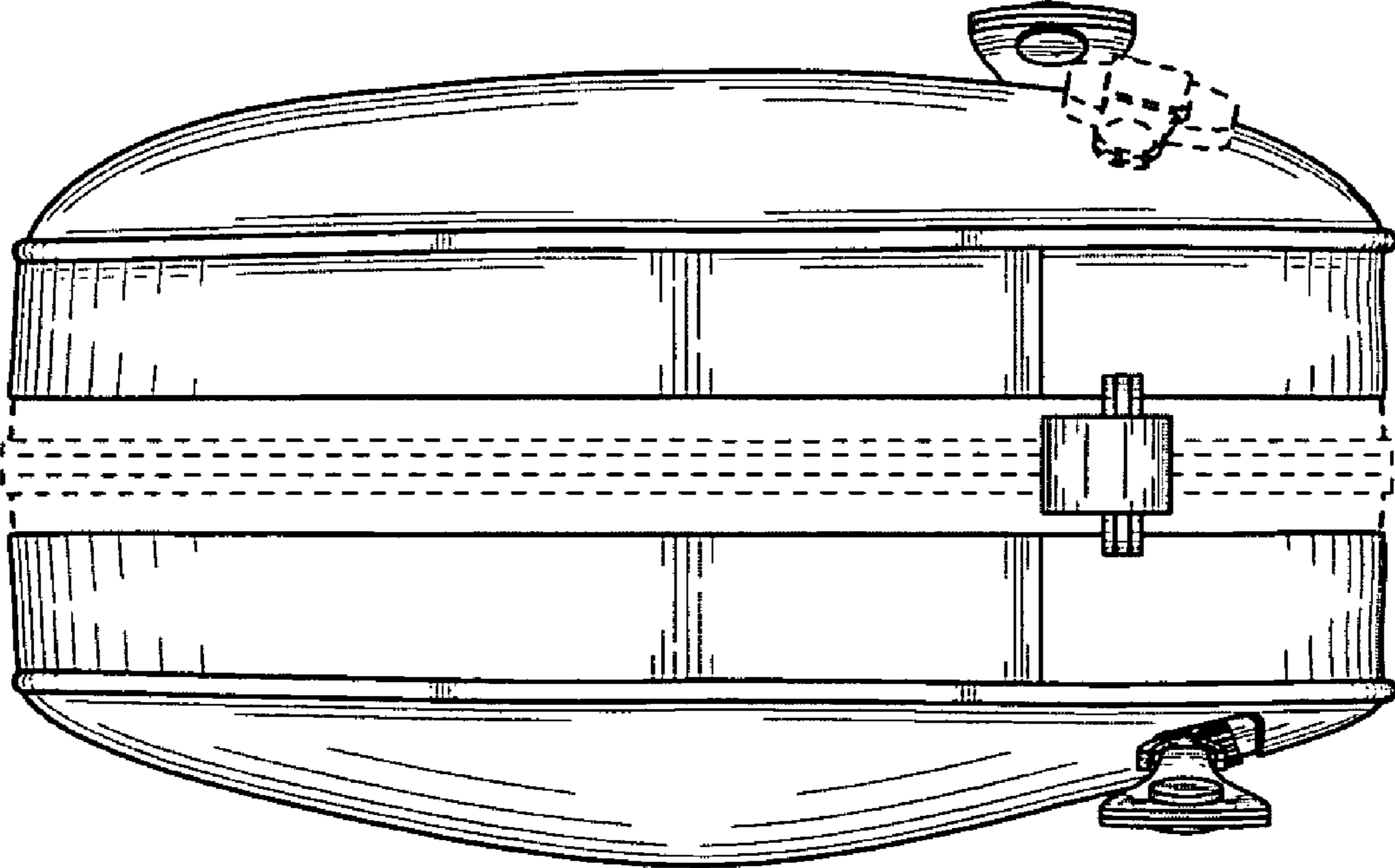

FIG. 14