



US00D585163S

(12) **United States Design Patent**
Carrasco

(10) **Patent No.:** **US D585,163 S**
(45) **Date of Patent:** **** Jan. 20, 2009**

(54) **PET SCRATCHING DEVICE**

(76) Inventor: **Richard S. Carrasco**, 110 S. Shaw St.,
Tom Bean, TX (US) 75489

(**) Term: **14 Years**

(21) Appl. No.: **29/282,968**

(22) Filed: **Aug. 2, 2007**

(51) **LOC (9) Cl.** **30-99**

(52) **U.S. Cl.** **D30/199; D30/158**

(58) **Field of Classification Search** D30/155,
D30/156, 160, 199, 158, 159, 162; 119/706,
119/707, 600, 601, 604-606, 611-619, 625,
119/628-633; D28/91.2, 99; D24/211, 214,
D24/147; 601/137, 107, 101, 103, 136, 93,
601/95, 120, 135; D7/690, 672, 692, 688,
D7/412, 376-380, 643, 653; 15/14.1, 236.01,
15/236.08, 143.1, 188; D18/15; D8/14,
D8/107, 13; D4/136; D32/51, 46, 49; 241/301,
241/169.2; 54/24; 416/223 R, 77, 70 R,
416/72; 366/129, 343; 140/71 R; 231/2.1,
231/7, 4, 5; 446/421; 463/47.2, 47.7; 428/32
See application file for complete search history.

(56) **References Cited**

U.S. PATENT DOCUMENTS

61,070	A *	1/1867	Hull	231/2.1
RE3,754	E *	11/1869	Hull	231/2.1
125,134	A *	4/1872	Holmes	231/2.1
RE5,960	E *	7/1874	Holmes	231/2.1
261,550	A *	7/1882	Hull	231/2.1
323,447	A *	8/1885	Ruebsam	601/107
592,559	A *	10/1897	Bennett	15/141.1
671,516	A *	4/1901	Hegner	416/72
D35,313	S *	11/1901	Wirt	D24/211
815,199	A *	3/1906	Monetti	231/2.1
1,713,876	A *	5/1929	Knuppe	241/301
1,734,082	A *	11/1929	Farlin	231/2.1
4,266,459	A *	5/1981	Seregely	84/402

D268,536	S *	4/1983	Davis	D30/155
4,863,095	A *	9/1989	Crane	231/2.1
D311,605	S *	10/1990	Clayton	D28/91.2
D315,792	S *	3/1991	Kachigian	D24/147
D371,818	S *	7/1996	Stolz	D21/756
D385,632	S *	10/1997	Chen	D24/214
5,728,050	A *	3/1998	Lin	601/107
D406,342	S *	3/1999	Stefano	D24/147
5,904,661	A *	5/1999	Bonz et al.	601/137
D431,113	S *	9/2000	Kwok	D4/136
6,112,980	A *	9/2000	Jones	231/2.1
D445,316	S *	7/2001	Borner	D7/690
6,264,356	B1 *	7/2001	Borner	366/129
6,450,980	B1 *	9/2002	Robbins et al.	601/137
D468,066	S *	12/2002	Helms et al.	D30/156
D504,928	S *	5/2005	Miller	D21/756
2002/0047806	A1 *	4/2002	Ishikawa	343/702
2003/0018285	A1 *	1/2003	Robbins et al.	601/137
2003/0083600	A1 *	5/2003	Robbins et al.	601/133

* cited by examiner

Primary Examiner—Susan Moon Lee

(74) *Attorney, Agent, or Firm*—QuickPatents, Inc.; Kevin Prince

(57) **CLAIM**

I claim the ornamental design for a pet scratching device, as shown and described.

DESCRIPTION

FIG. 1 is a perspective view of a pet scratching device, showing my new design;

FIG. 2 is a front elevational view of the invention;

FIG. 3 is a rear elevational view of the invention;

FIG. 4 is a left-side elevational view of the invention, the right-side elevational view being a mirror image thereof;

FIG. 5 is a top plan view of the invention; and,

FIG. 6 is a bottom plan view of the invention.

1 Claim, 2 Drawing Sheets

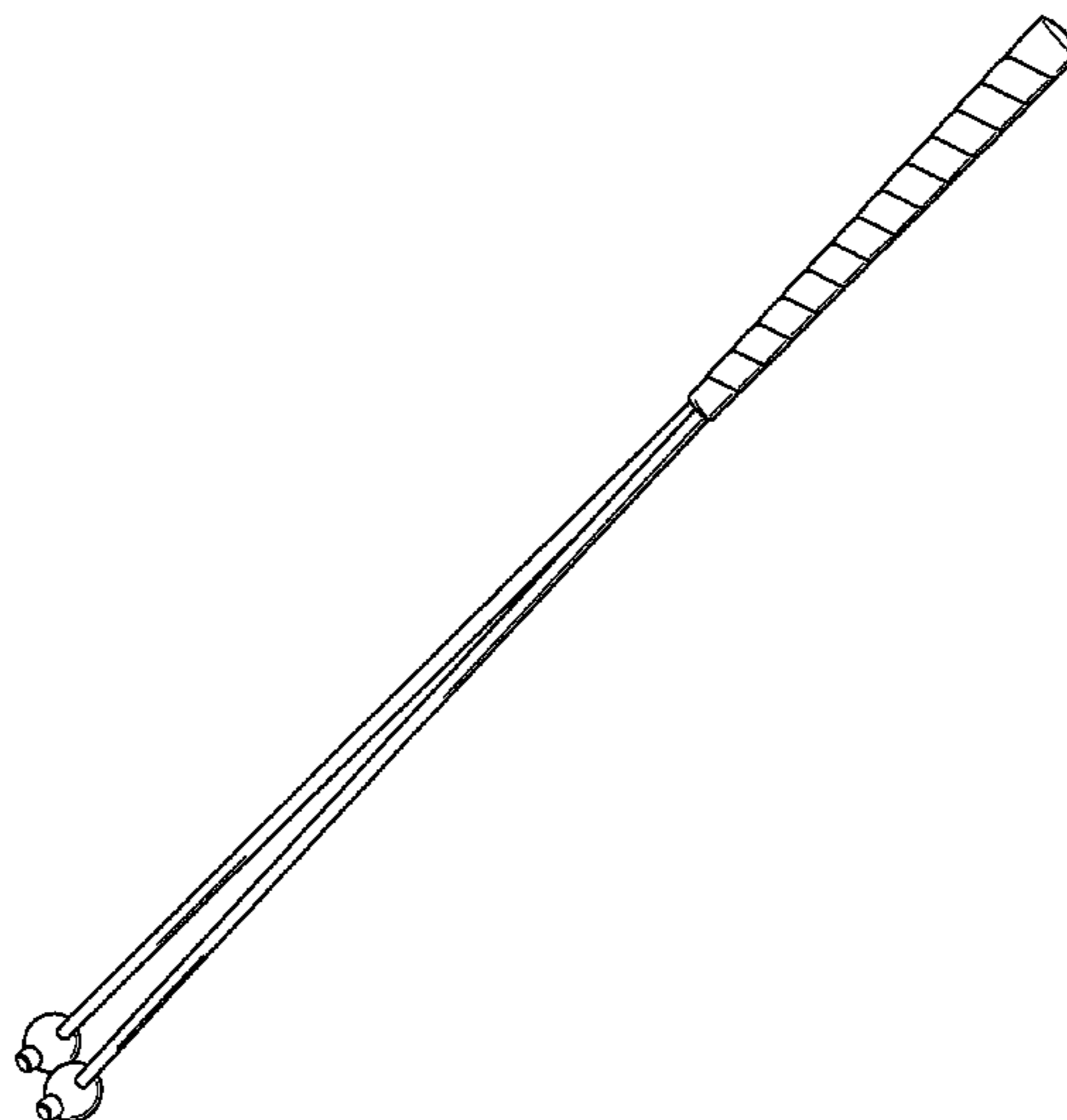

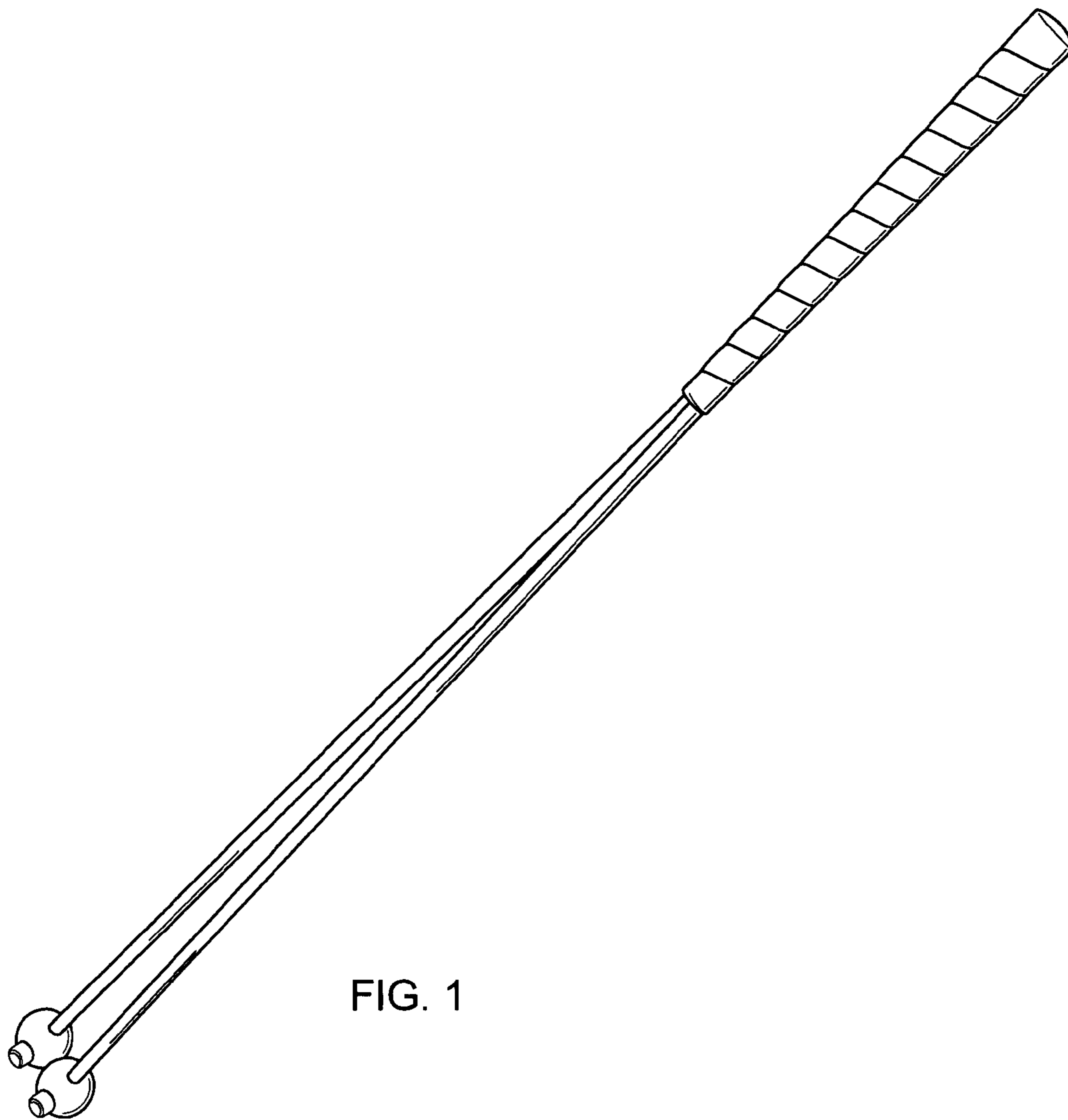

FIG. 1

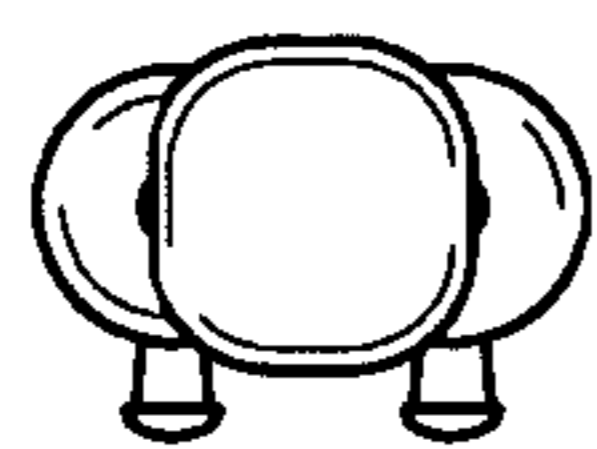

FIG. 5

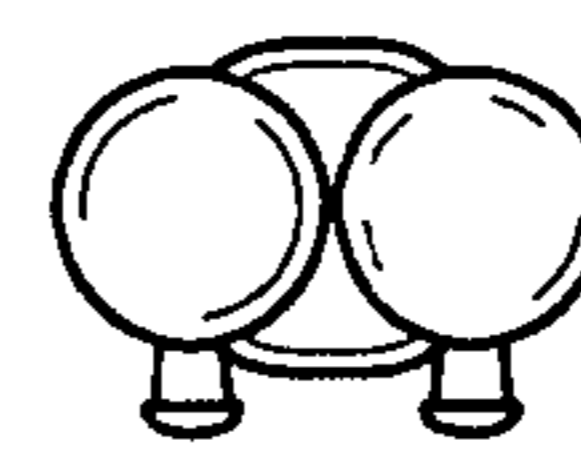

FIG. 6

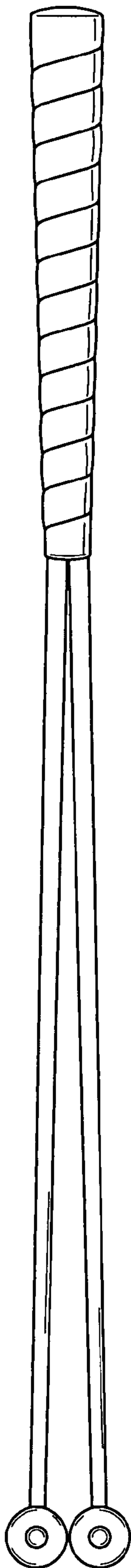

FIG. 2

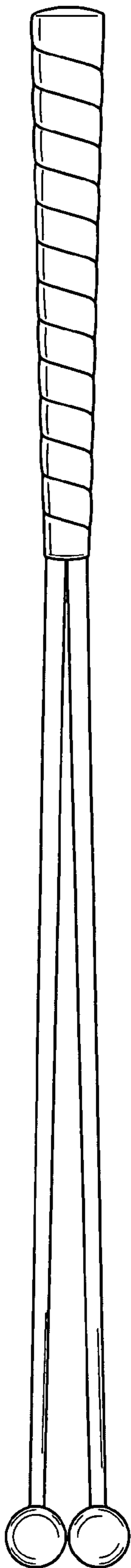

FIG. 3

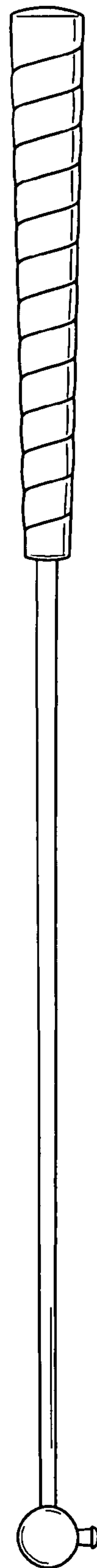

FIG. 4