



US00D585046S

(12) **United States Design Patent**
Yamada

(10) **Patent No.:** **US D585,046 S**
(45) **Date of Patent:** **** Jan. 20, 2009**

(54) **MOBILE PHONE**

(75) Inventor: **Yoshinori Yamada**, Malmö (SE)

(73) Assignee: **Sony Ericsson Mobile Communications AB**, Lund (SE)

(**) Term: **14 Years**

(21) Appl. No.: **29/306,869**

(22) Filed: **Apr. 17, 2008**

(30) **Foreign Application Priority Data**

Oct. 25, 2007 (EM) 00081489200010002

(51) **LOC (9) Cl.** **14-03**

(52) **U.S. Cl.** **D14/138 AB**

(58) **Field of Classification Search** D14/138,
D14/496, 341, 345, 346; 455/575.3, 575.1
See application file for complete search history.

(56) **References Cited**

U.S. PATENT DOCUMENTS

- D352,503 S * 11/1994 Nagele D14/138 AB
- D470,845 S * 2/2003 Hyun D14/393
- D513,742 S * 1/2006 Arnholt et al. D14/138 AB
- D536,320 S * 2/2007 Michaels D14/138 AB
- D536,690 S * 2/2007 Lee D14/138 AD
- D537,059 S * 2/2007 Hwang D14/138 AB
- 7,269,443 B2 * 9/2007 Park et al. 455/556.2
- D556,719 S * 12/2007 Lee D14/138 AB
- D557,240 S * 12/2007 Lee D14/138 AB
- D557,243 S * 12/2007 Kim et al. D14/138 AD
- D561,146 S * 2/2008 Finney et al. D14/138 AD
- D561,719 S * 2/2008 Cho D14/138 AB
- D562,794 S * 2/2008 Kim et al. D14/138 AD
- D562,796 S * 2/2008 Sohn et al. D14/138 AD
- 7,352,330 B2 * 4/2008 Komine 343/702
- D568,852 S * 5/2008 Park D14/138 AB
- D570,323 S * 6/2008 Okada et al. D14/138 AD
- D571,332 S * 6/2008 Lee et al. D14/138
- D571,344 S * 6/2008 Kim et al. D14/138
- D572,690 S * 7/2008 Kim et al. D14/138
- D575,755 S * 8/2008 Kim et al. D14/138

- D575,761 S * 8/2008 Kim D14/138
- D576,594 S * 9/2008 Lee et al. D14/138 R
- D576,599 S * 9/2008 Han et al. D14/138 R
- 2004/0224730 A1 * 11/2004 Sakai et al. 455/575.3
- 2006/0135225 A1 * 6/2006 Lin et al. 455/575.3

OTHER PUBLICATIONS

Sony Ericsson W980 telephone, announced Feb. 2008, [online], [site visited Sep. 9, 2008]. Available from Internet ,<URL: <http://www.gsmarena.com>>.*

(Continued)

Primary Examiner—Jeffrey D Asch

(74) *Attorney, Agent, or Firm*—Renner, Otto, Boisselle & Sklar, LLP

(57) **CLAIM**

The ornamental design for a mobile telephone, as shown and described.

DESCRIPTION

FIG. 1 is a front view of a mobile phone in a closed position showing my design;

FIG. 2 is a rear view thereof;

FIG. 3 is a right side view thereof;

FIG. 4 is a left side view thereof;

FIG. 5 is a top view thereof;

FIG. 6 is a bottom view thereof;

FIG. 7 is a perspective view thereof;

FIG. 8 is a front view of the mobile phone of FIG. 1 in an open position;

FIG. 9 is a rear perspective view thereof;

FIG. 10 is a right side view thereof;

FIG. 11 is a left side view thereof;

FIG. 12 is a top view thereof;

FIG. 13 is a bottom view thereof; and,

FIG. 14 is a perspective view thereof.

1 Claim, 7 Drawing Sheets

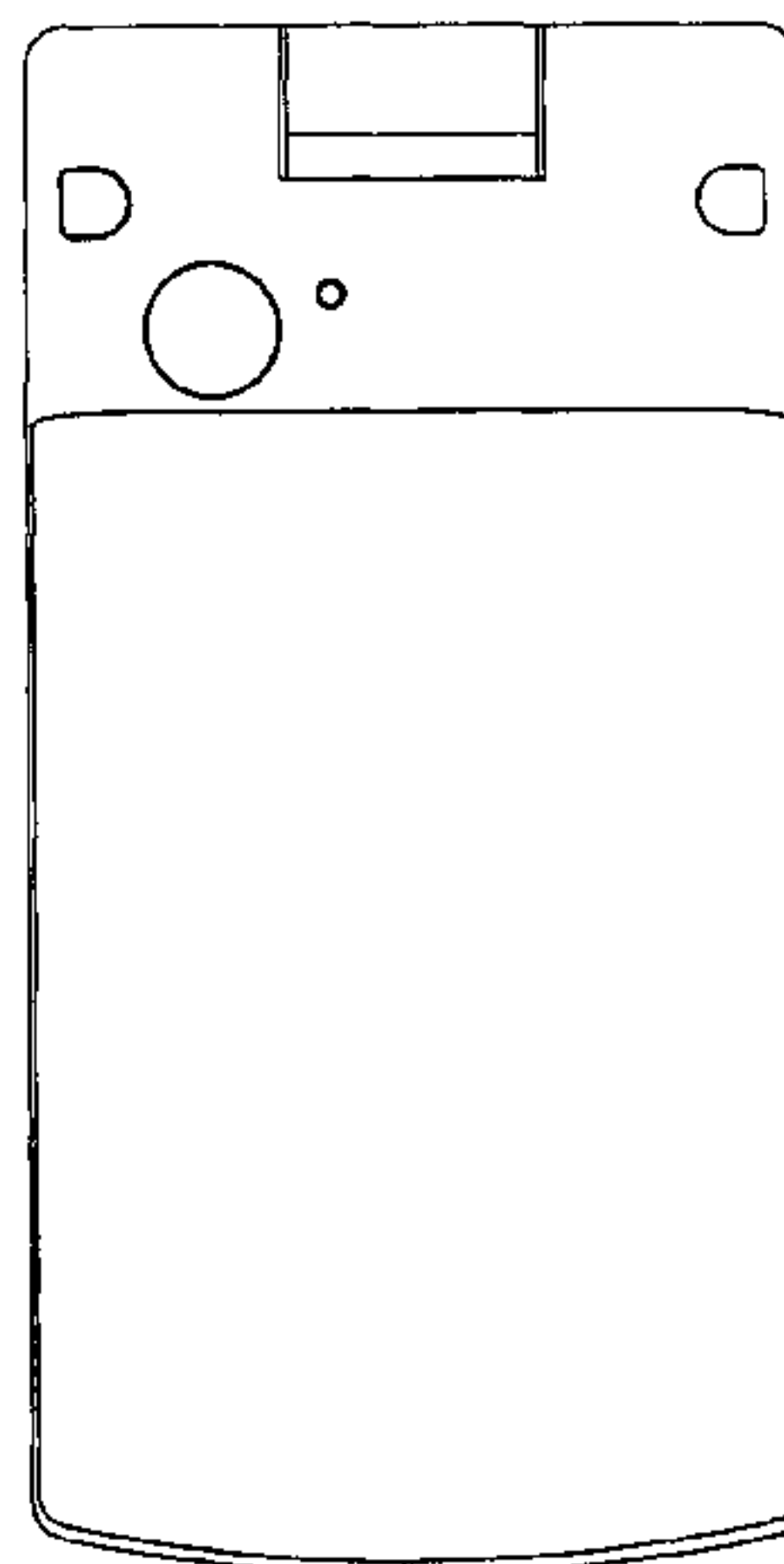
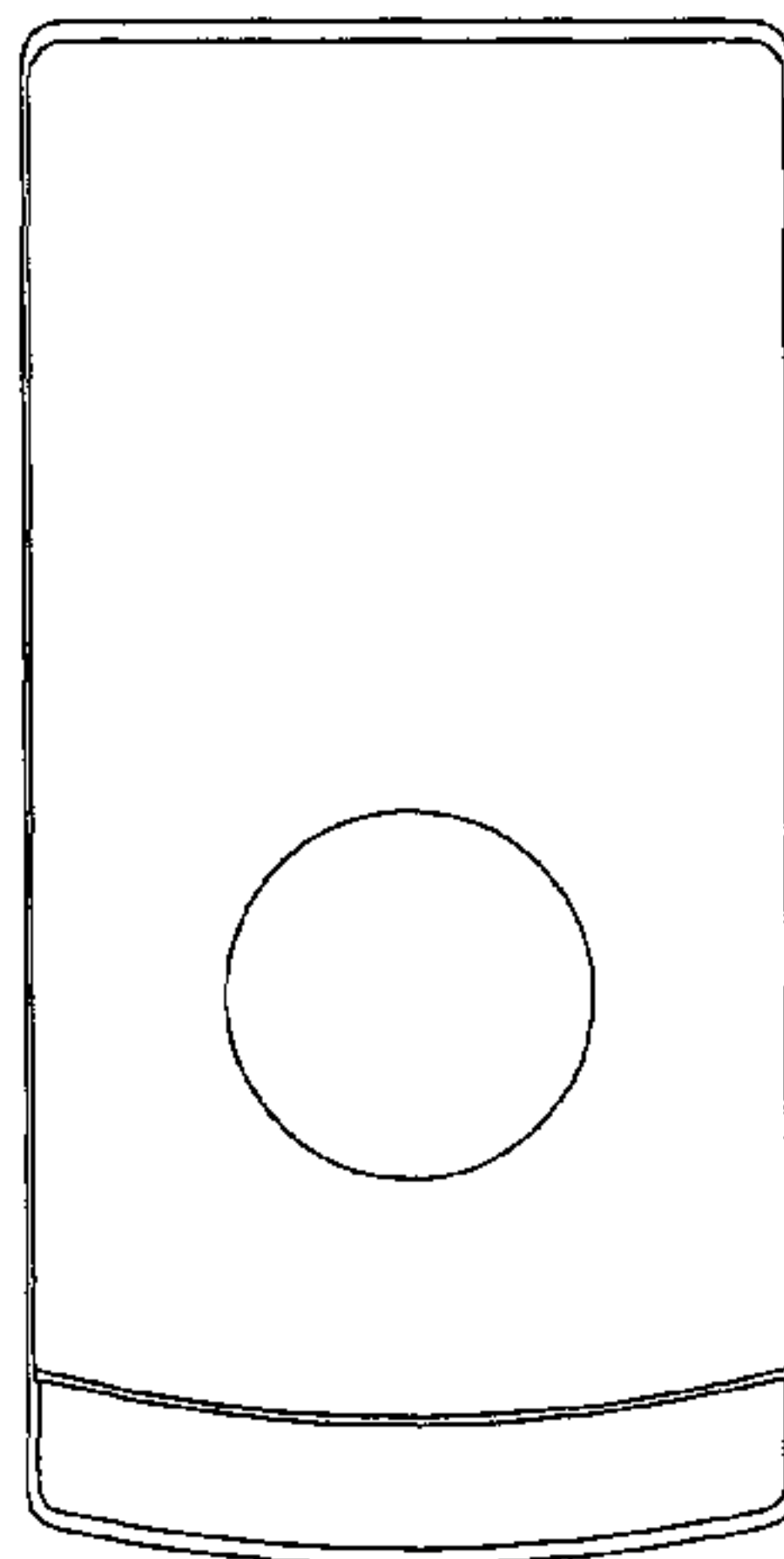

OTHER PUBLICATIONS

Sony Ericsson TM506 telephone, announced Aug. 2008, [online], [site visited Sep. 9, 2008]. Available from Internet, <URL: <http://www.gsmarena.com>>.*

Toshiba TS10 telephone, announced 3rd quarter 2005, [online], [site visited Sep. 9, 2008]. Available from Internet, <URL: <http://www.gsmarena.com>>.*

BenQ T51 telephone, announced Aug. 2007, [online], [site visited Sep. 9, 2008]. Available from Internet, <URL: <http://www.gsmarena.com>>.*

Bird M01 telephone, announced 2007, [online], [site visited Sep. 9, 2008]. Available from Internet, <URL: <http://www.gsmarena.com>>.*

* cited by examiner

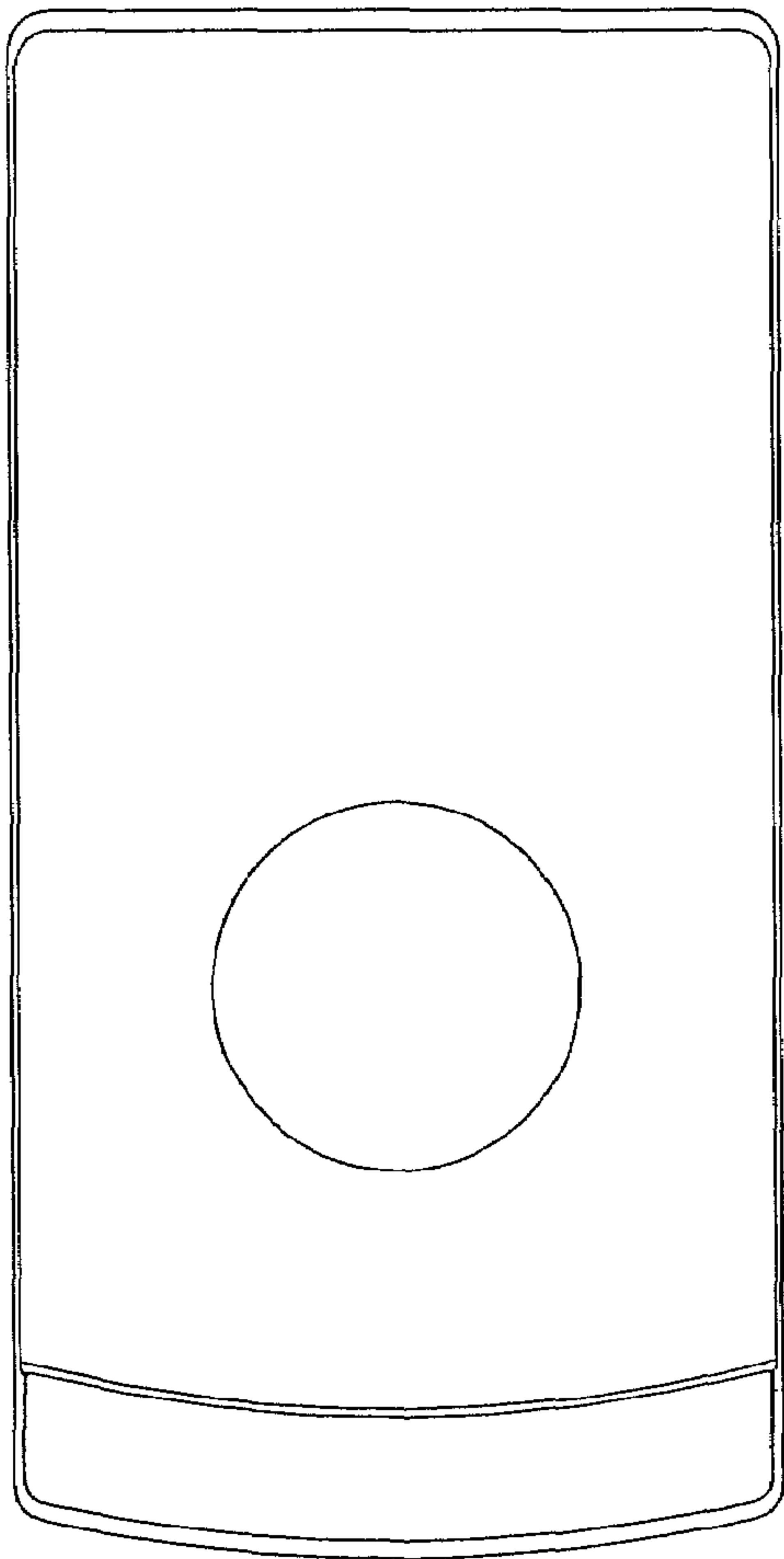

FIG. 1

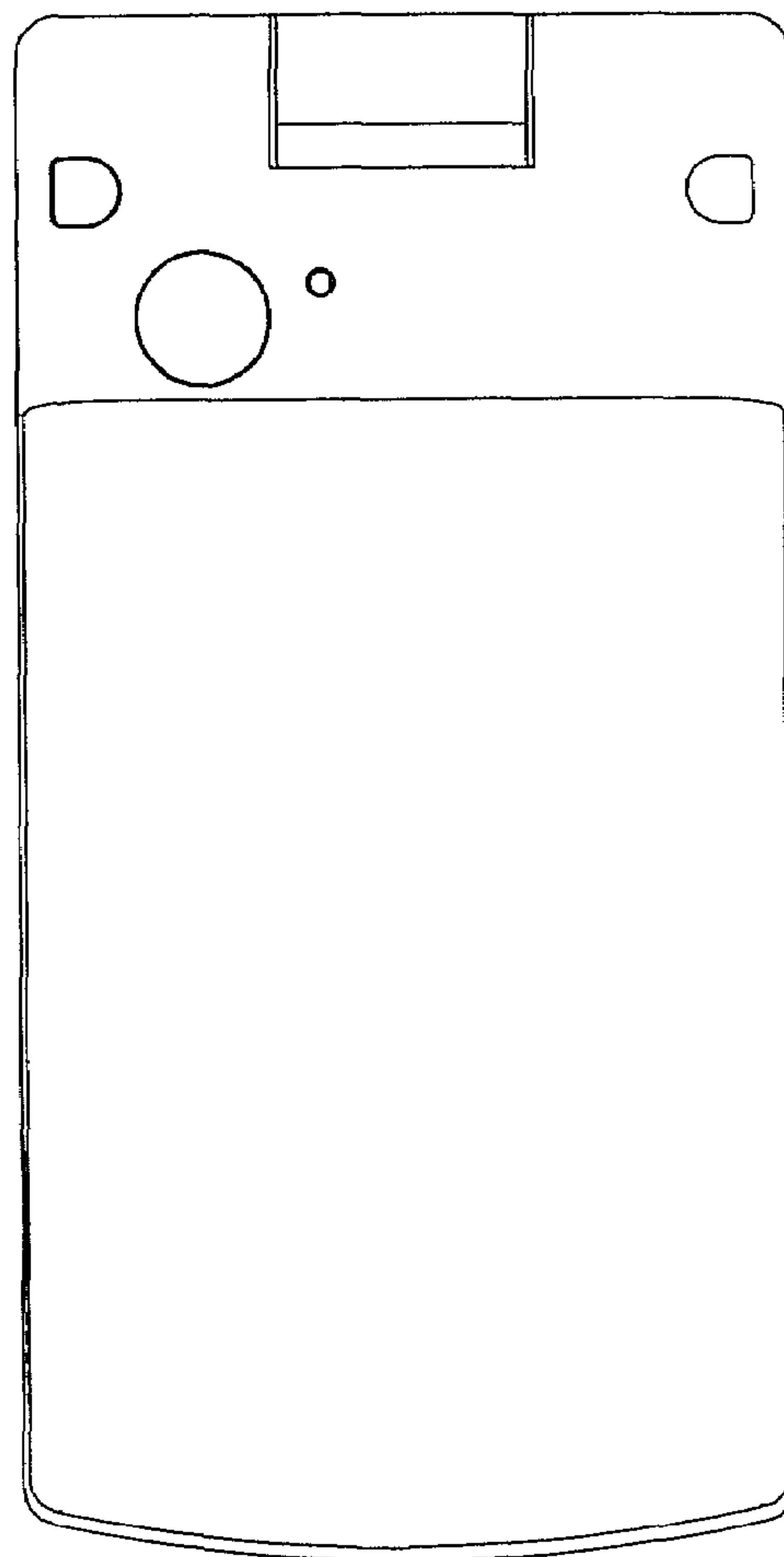

FIG. 2

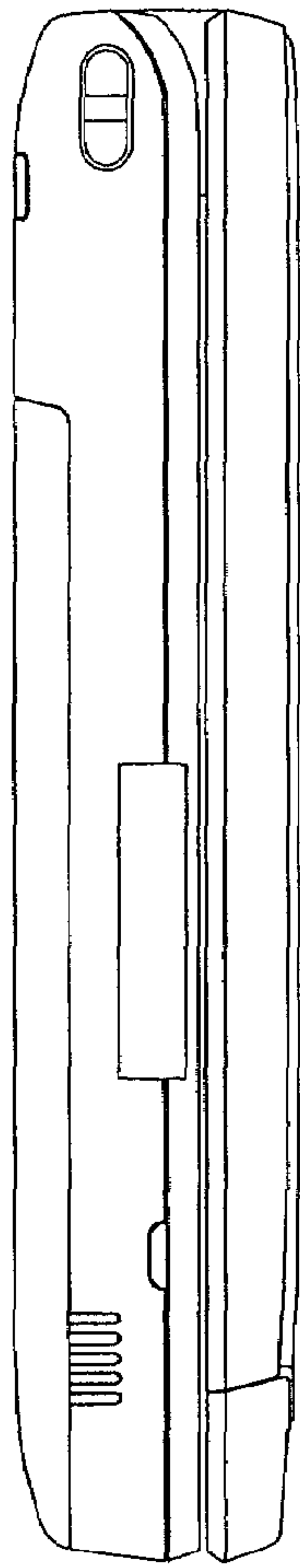

FIG. 4

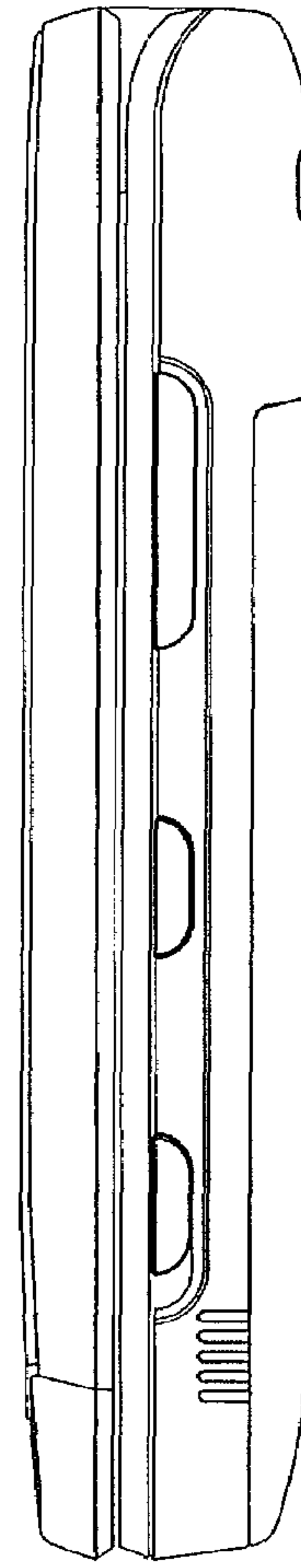

FIG. 3

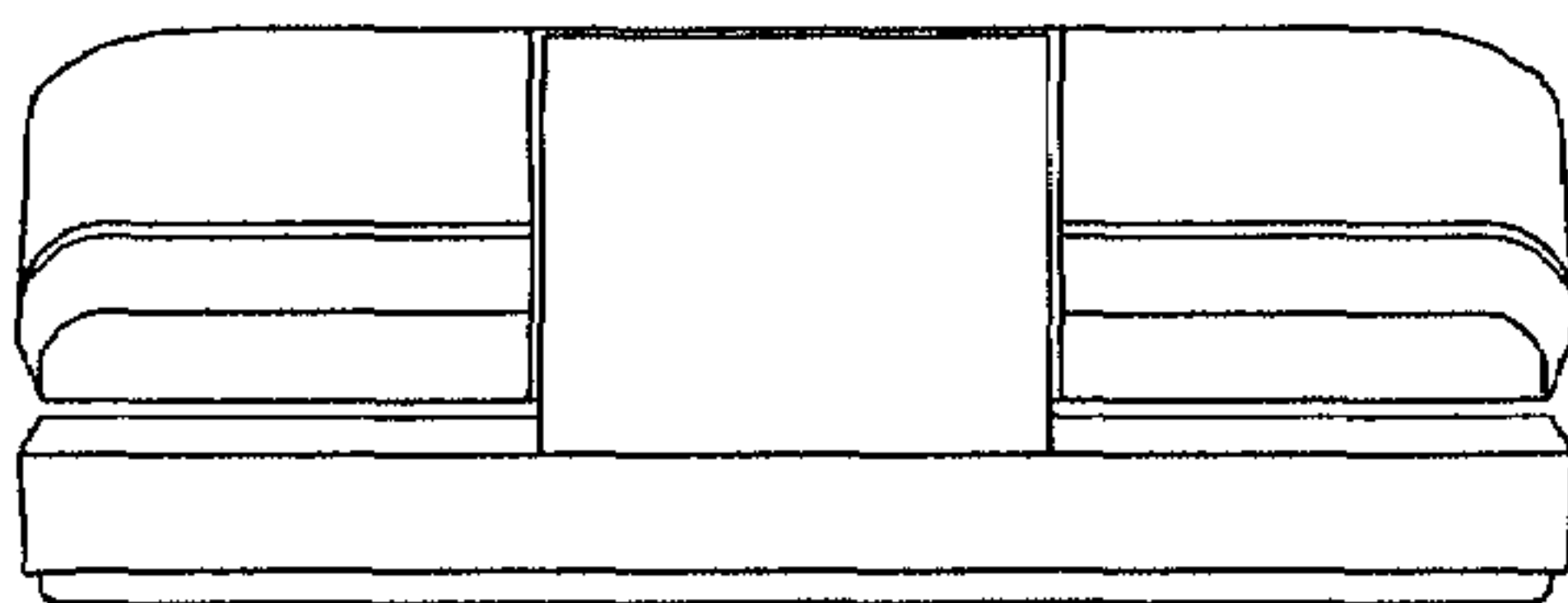

FIG. 5

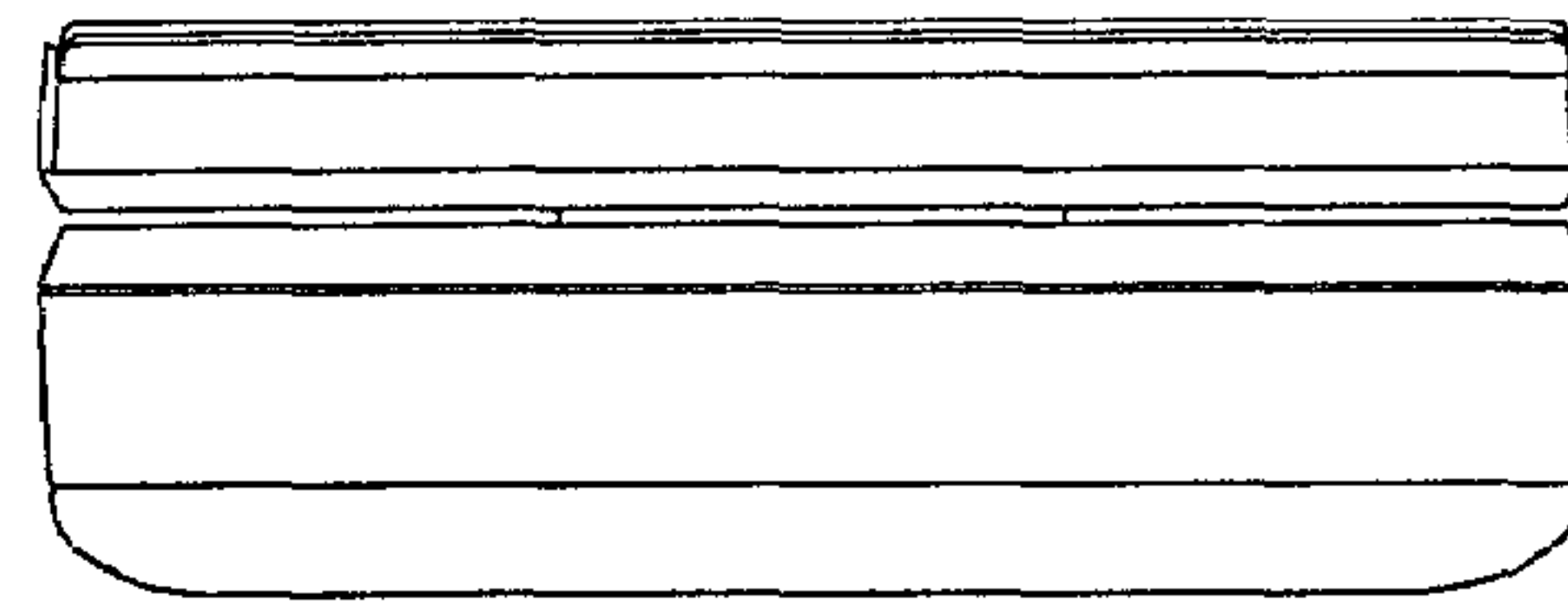

FIG. 6

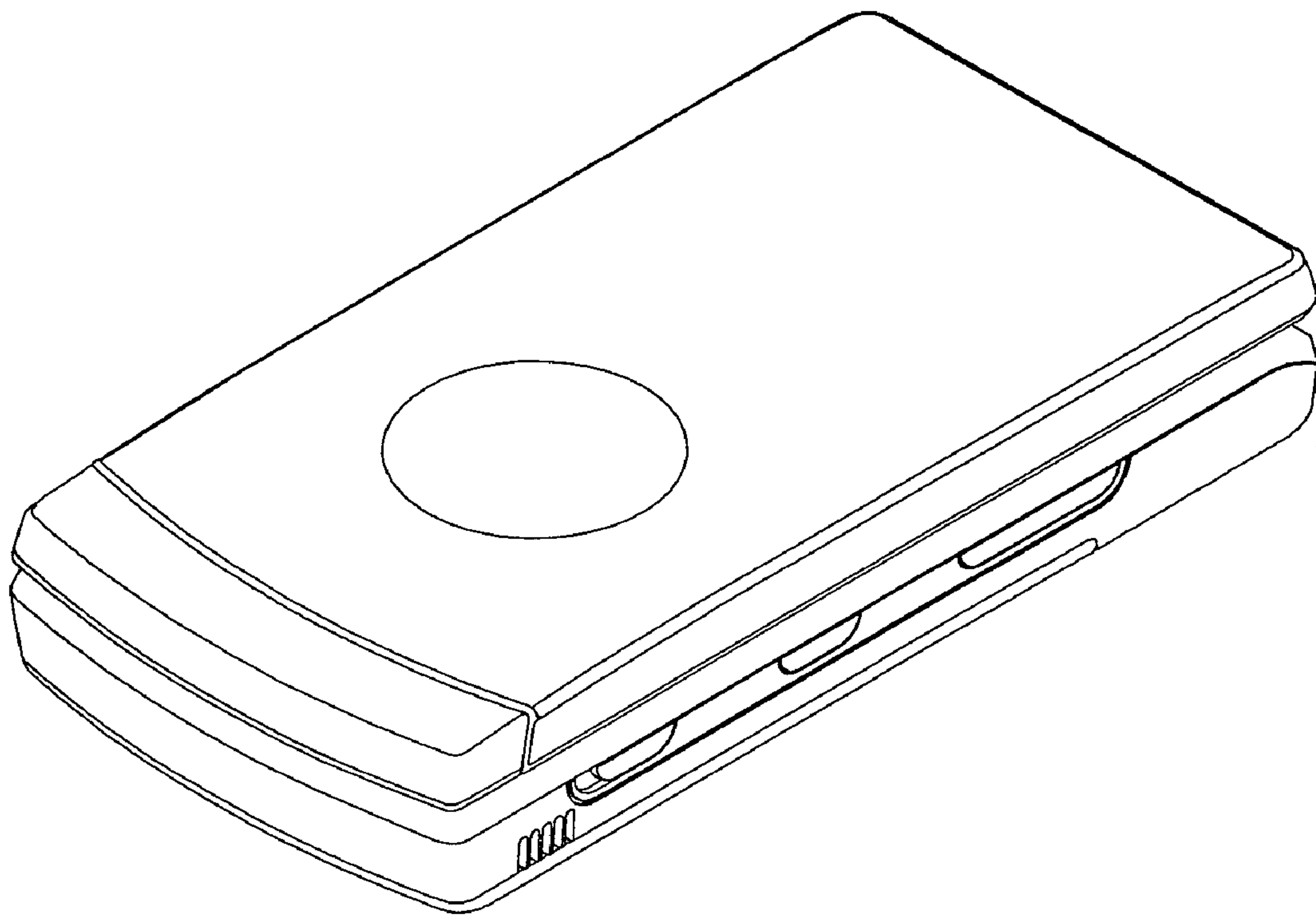

FIG. 7

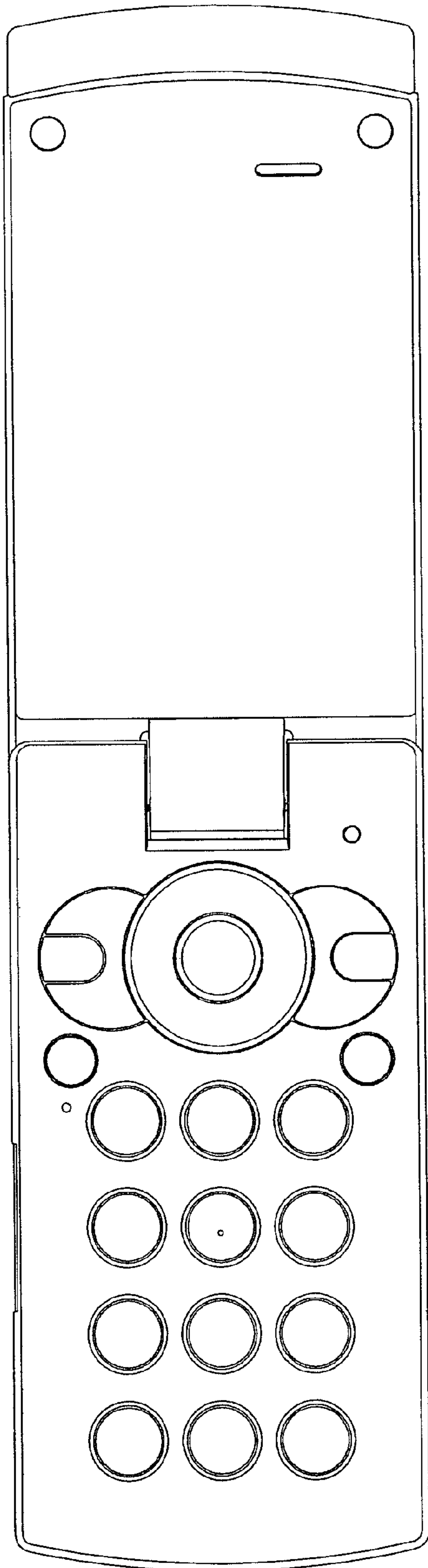

FIG. 8

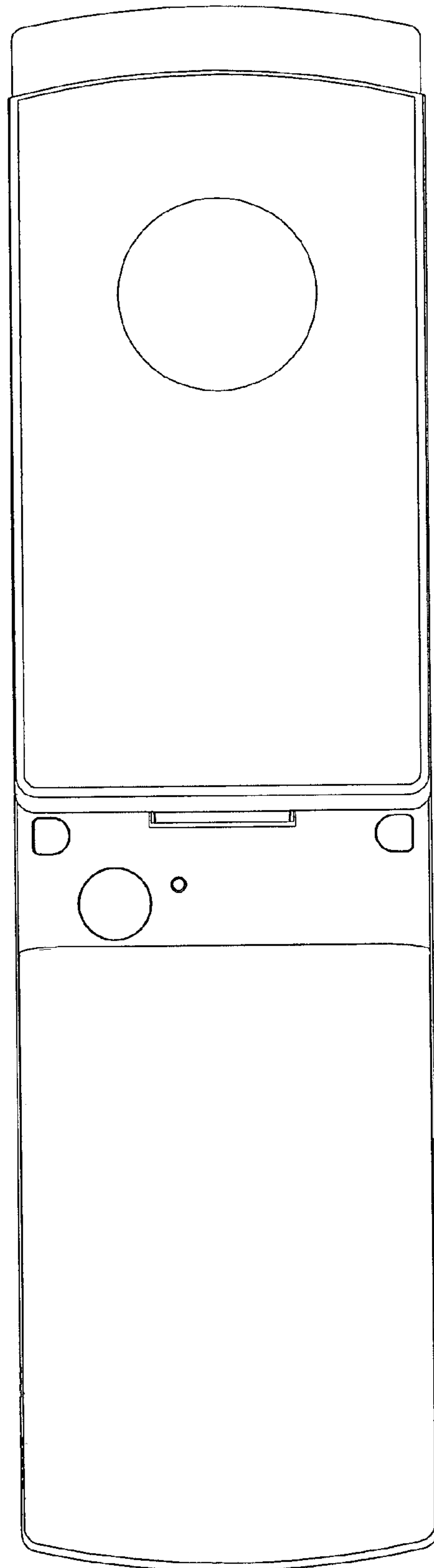

FIG. 9

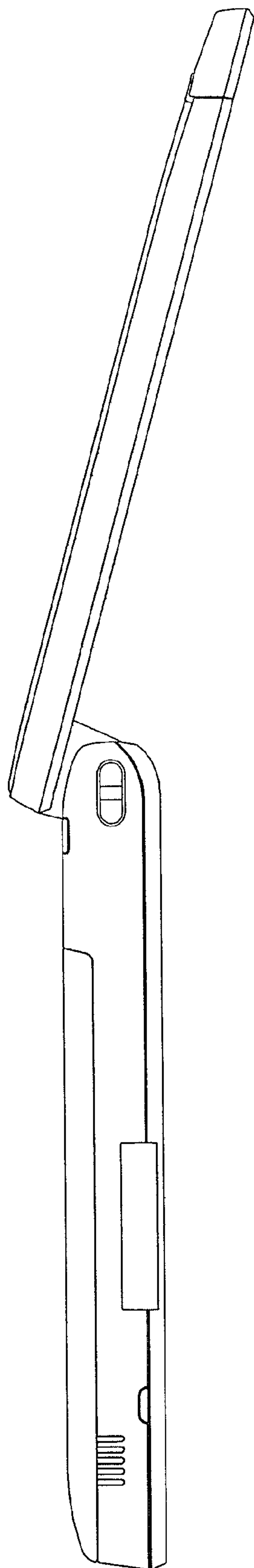

FIG. 11

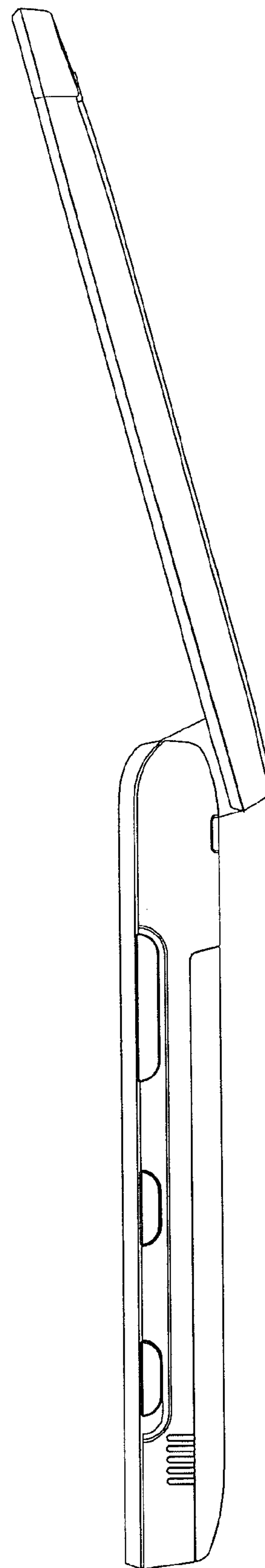

FIG. 10

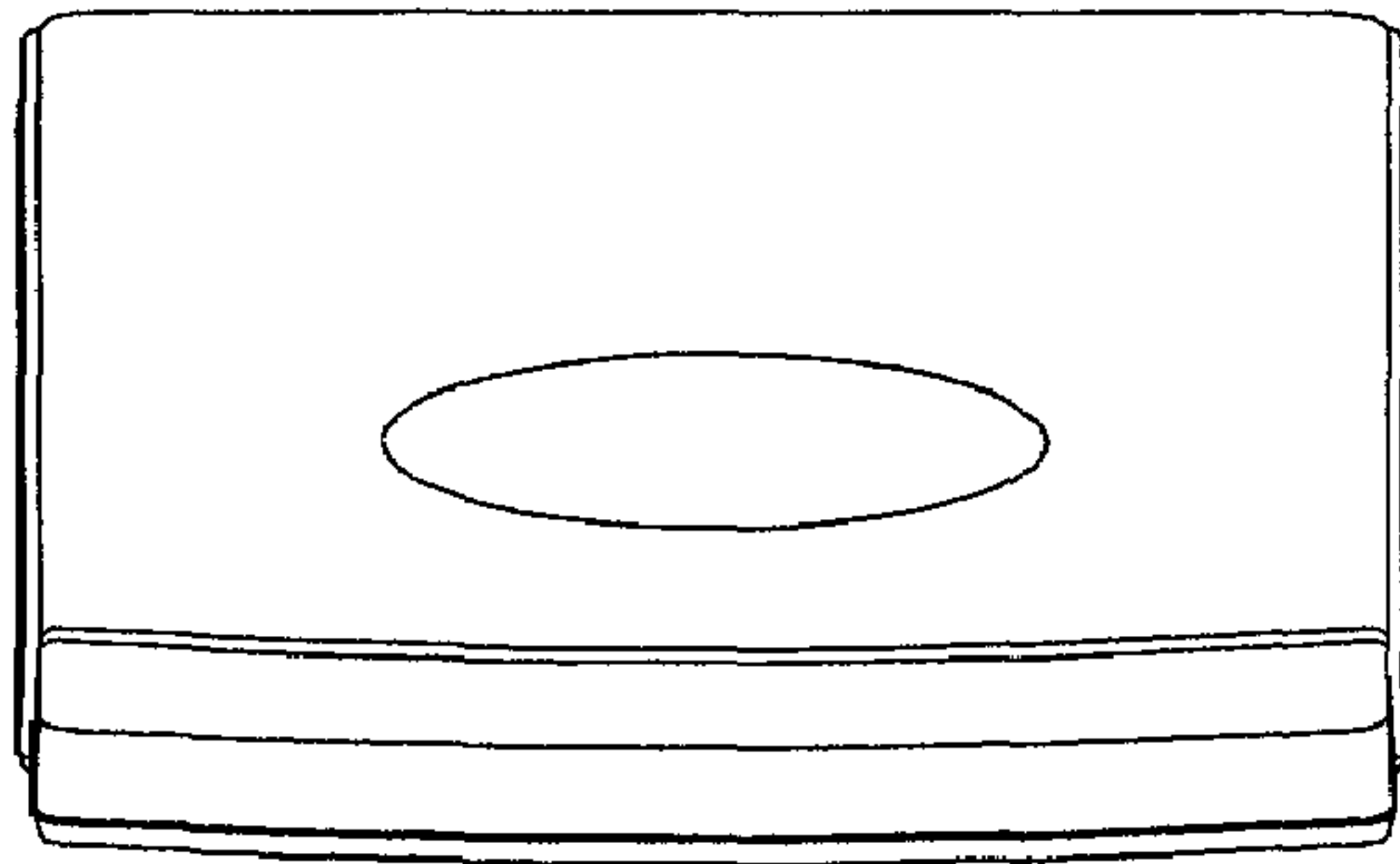

FIG. 12

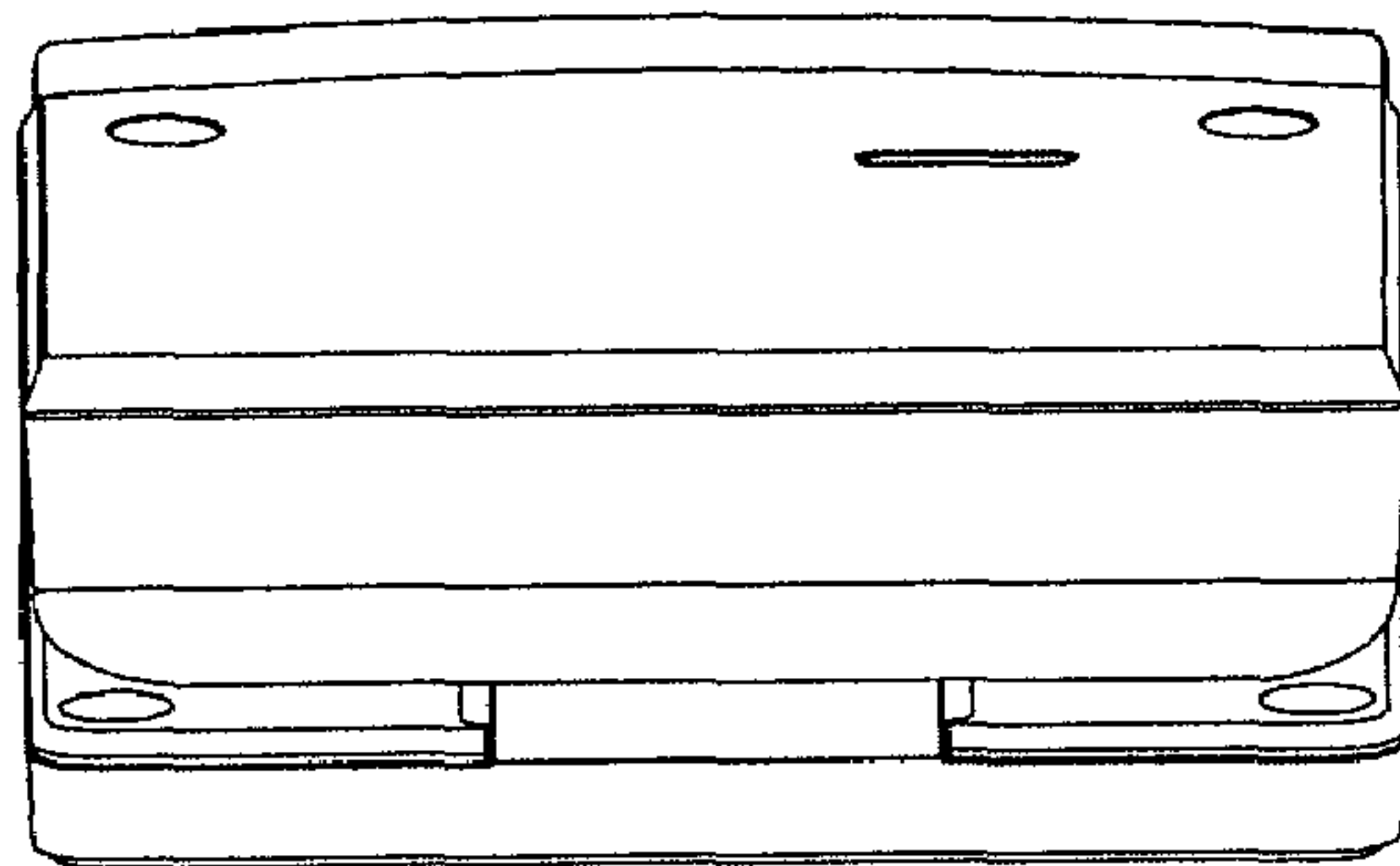

FIG. 13

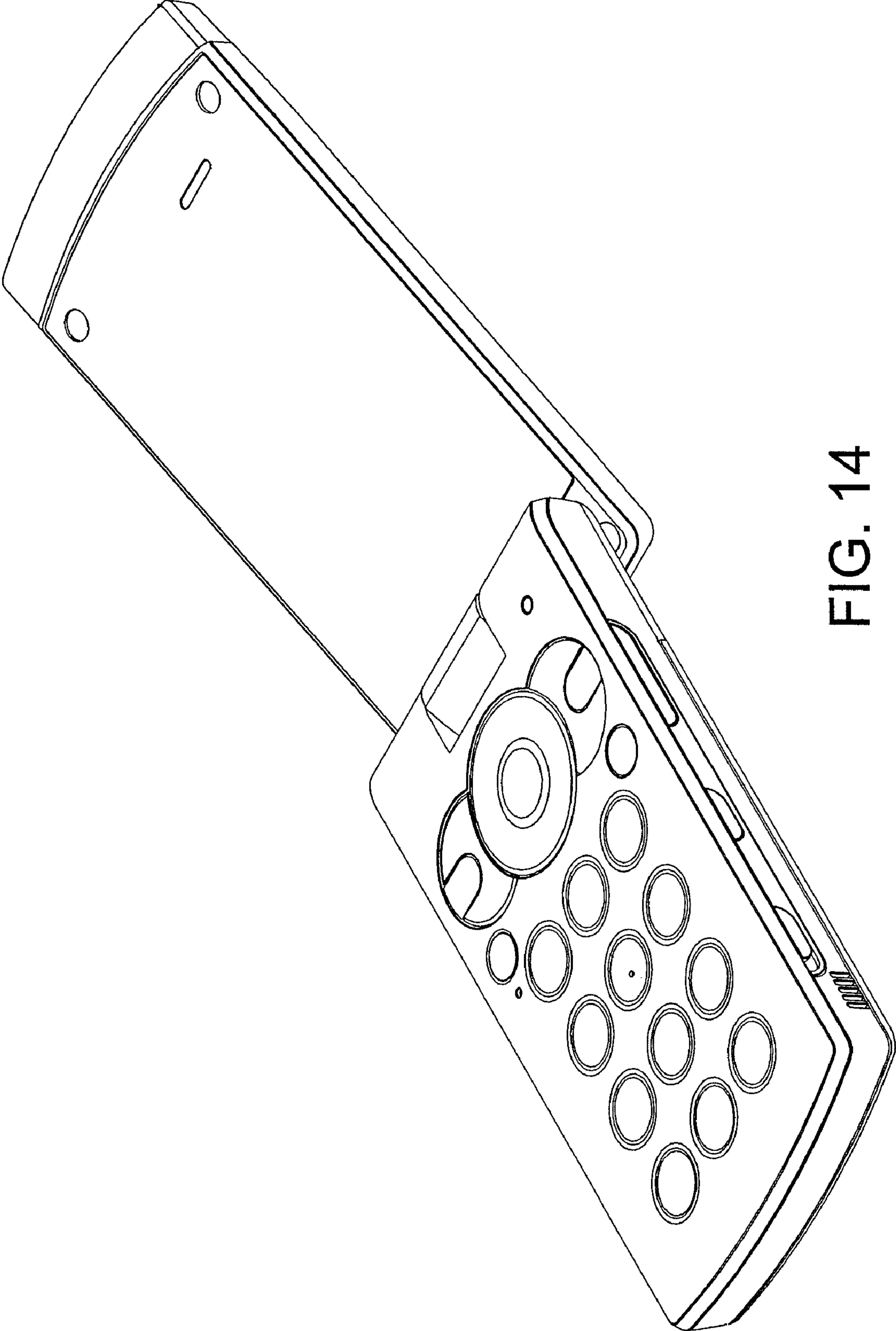

FIG. 14