



US00D585041S

(12) **United States Design Patent**  
**Han et al.**

(10) **Patent No.:** **US D585,041 S**  
(45) **Date of Patent:** **\*\* Jan. 20, 2009**

(54) **PORTABLE PHONE**

(75) Inventors: **Woo-Seung Han**, Seoul (KR);  
**Seung-Min Park**, Seoul (KR);  
**Chang-Hwan Hwang**, Goyang-Si (KR)

(73) Assignee: **Samsung Electronics Co., Ltd.**,  
Suwon-Si (KR)

(\*\*) Term: **14 Years**

(21) Appl. No.: **29/300,104**

(22) Filed: **Feb. 20, 2008**

(30) **Foreign Application Priority Data**

Oct. 12, 2007 (KR) ..... 30-2007-0042503

(51) **LOC (9) Cl.** ..... **14-03**

(52) **U.S. Cl.** ..... **D14/138 AB**

(58) **Field of Classification Search** ..... D14/138,  
D14/496, 341-347; 455/575.3, 575.1  
See application file for complete search history.

(56) **References Cited**

**U.S. PATENT DOCUMENTS**

D502,161 S *	2/2005	Kim et al. ....	D14/138
D508,035 S *	8/2005	Kim et al. ....	D14/138
D521,970 S *	5/2006	Han et al. ....	D14/138
D537,059 S *	2/2007	Hwang .....	D14/138
D554,093 S *	10/2007	Arnholt et al. ....	D14/138
D557,230 S *	12/2007	Kim et al. ....	D14/138
D559,815 S *	1/2008	Moon et al. ....	D14/138
D559,816 S *	1/2008	Moon et al. ....	D14/138
D561,728 S *	2/2008	Kim et al. ....	D14/138
D563,376 S *	3/2008	Arnholt et al. ....	D14/138
D563,924 S *	3/2008	Arnold et al. ....	D14/138
D570,817 S *	6/2008	Han et al. ....	D14/138
D571,340 S *	6/2008	Song et al. ....	D14/138
D571,344 S *	6/2008	Kim et al. ....	D14/138
D571,771 S *	6/2008	Kim et al. ....	D14/138
D571,772 S *	6/2008	Kim et al. ....	D14/138

D571,773 S *	6/2008	Kim et al. ....	D14/138
D572,690 S *	7/2008	Kim et al. ....	D14/138
D573,127 S *	7/2008	Choi et al. ....	D14/138

**OTHER PUBLICATIONS**

Samsung E210 telephone, announced Aug. 2007, [online], [site visited Aug. 19, 2008]. Available from Internet ,<URL: http://www.gsmarena.com>.\*

LG KP210 telephone, announced Feb. 2008, [online], [site visited Aug. 19, 2008]. Available from Internet ,<URL: http://www.gsmarena.com>.\*

Pantech PG-2800 telephone, announced May 2006, [online], [site visited Aug. 19, 2008]. Available from Internet ,<URL: http://www.gsmarena.com>.\*

NEC 802 telephone, announced 3rd quarter 2004, [online], [site visited Aug. 19, 2008]. Available from Internet ,<URL: http://www.gsmarena.com>.\*

\* cited by examiner

*Primary Examiner*—Jeffrey D Asch

(74) *Attorney, Agent, or Firm*—Staas & Halsey LLP

(57) **CLAIM**

The ornamental design for a portable phone, as shown and described.

**DESCRIPTION**

FIG. 1 is a perspective view of a portable phone;  
FIG. 2 is a front view of the portable phone of FIG. 1;  
FIG. 3 is a rear view of the portable phone of FIG. 1;  
FIG. 4 is a left-side view of the portable phone of FIG. 1;  
FIG. 5 is a right-side view of the portable phone of FIG. 1;  
FIG. 6 is a top plan view of the portable phone of FIG. 1;  
FIG. 7 is a bottom plan view of the portable phone of FIG. 1;  
FIG. 8 is a front open view of the portable phone of FIG. 1;  
and,  
FIG. 9 is an in use front view of the portable phone of FIG. 1.

**1 Claim, 7 Drawing Sheets**

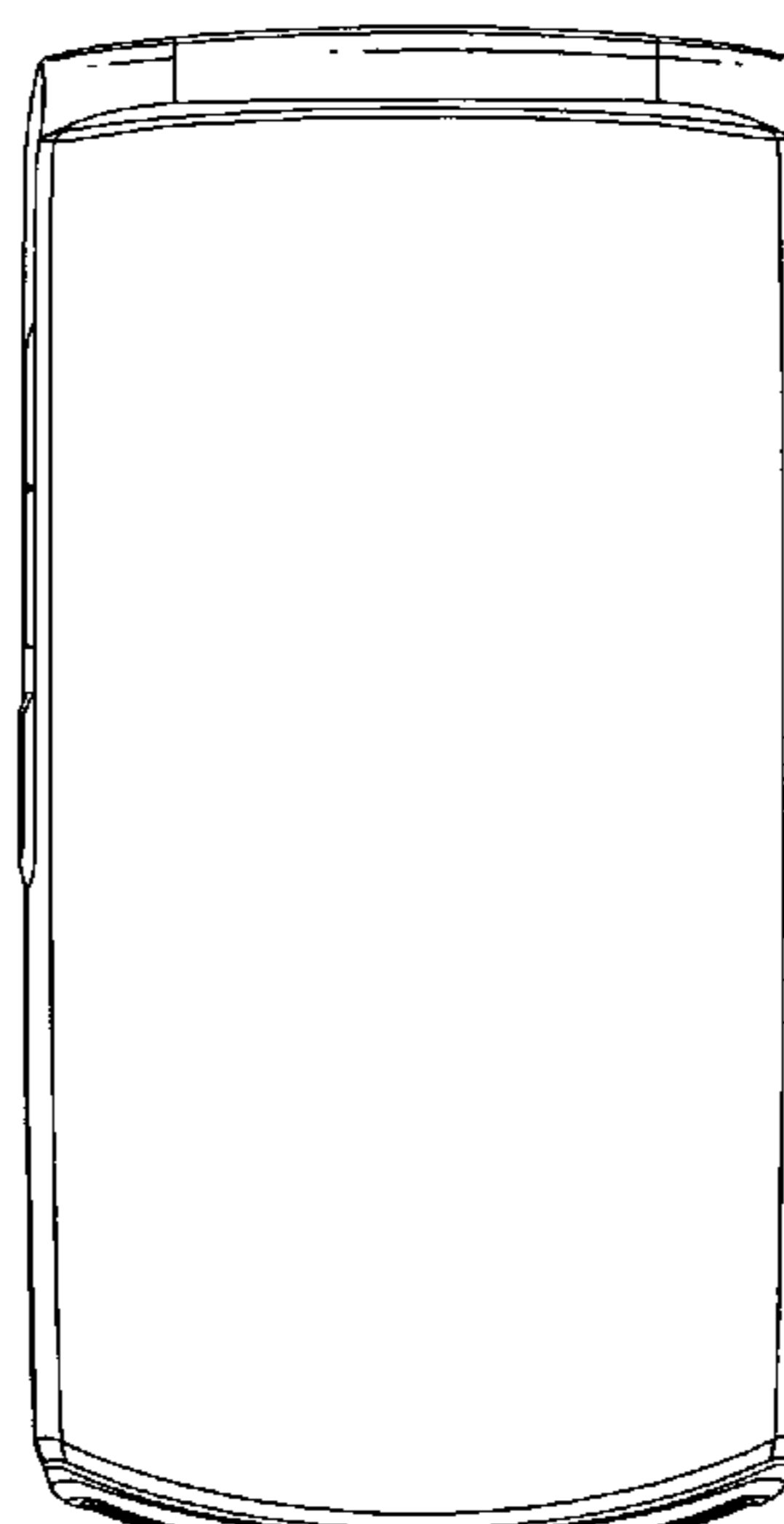
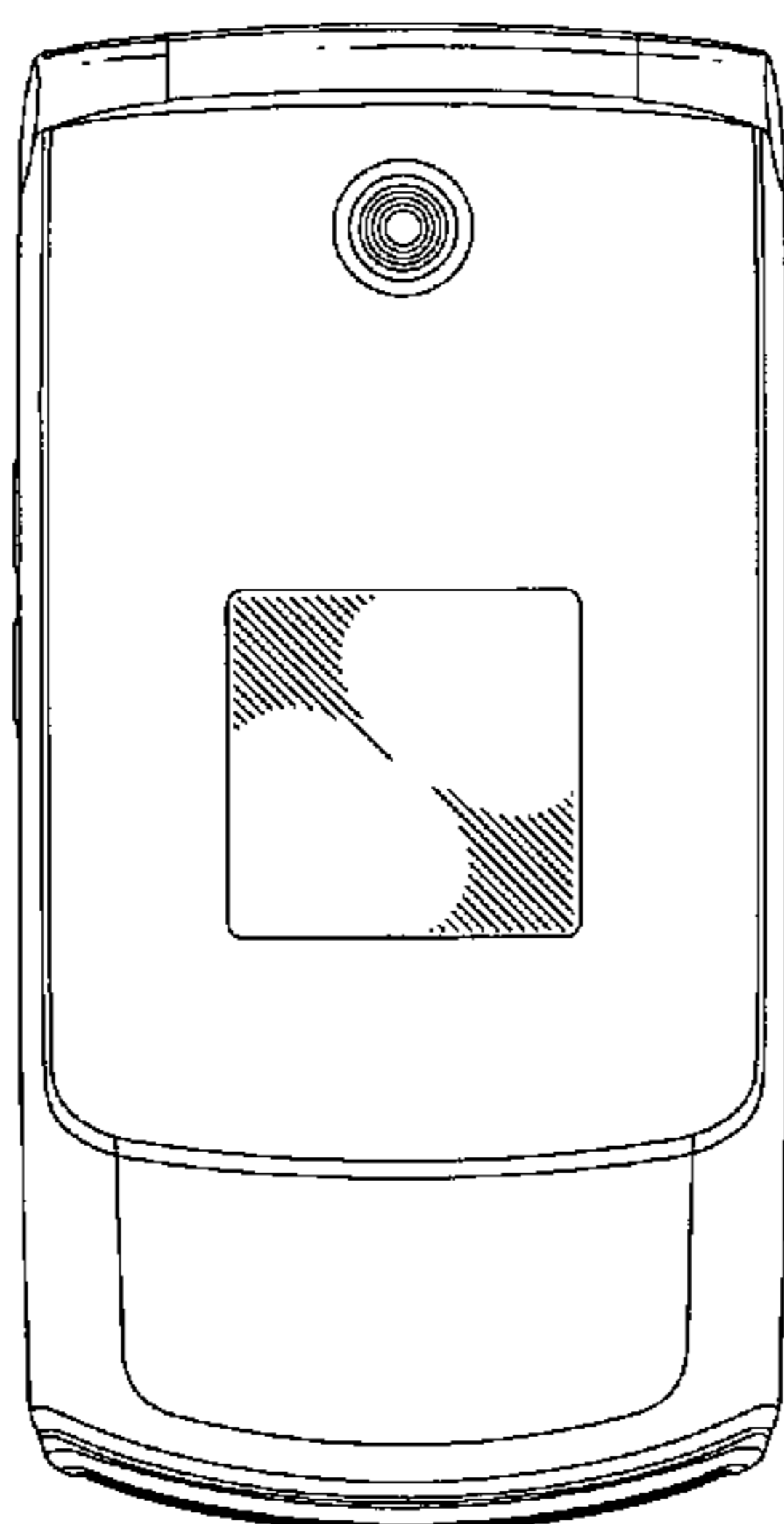

FIG. 1

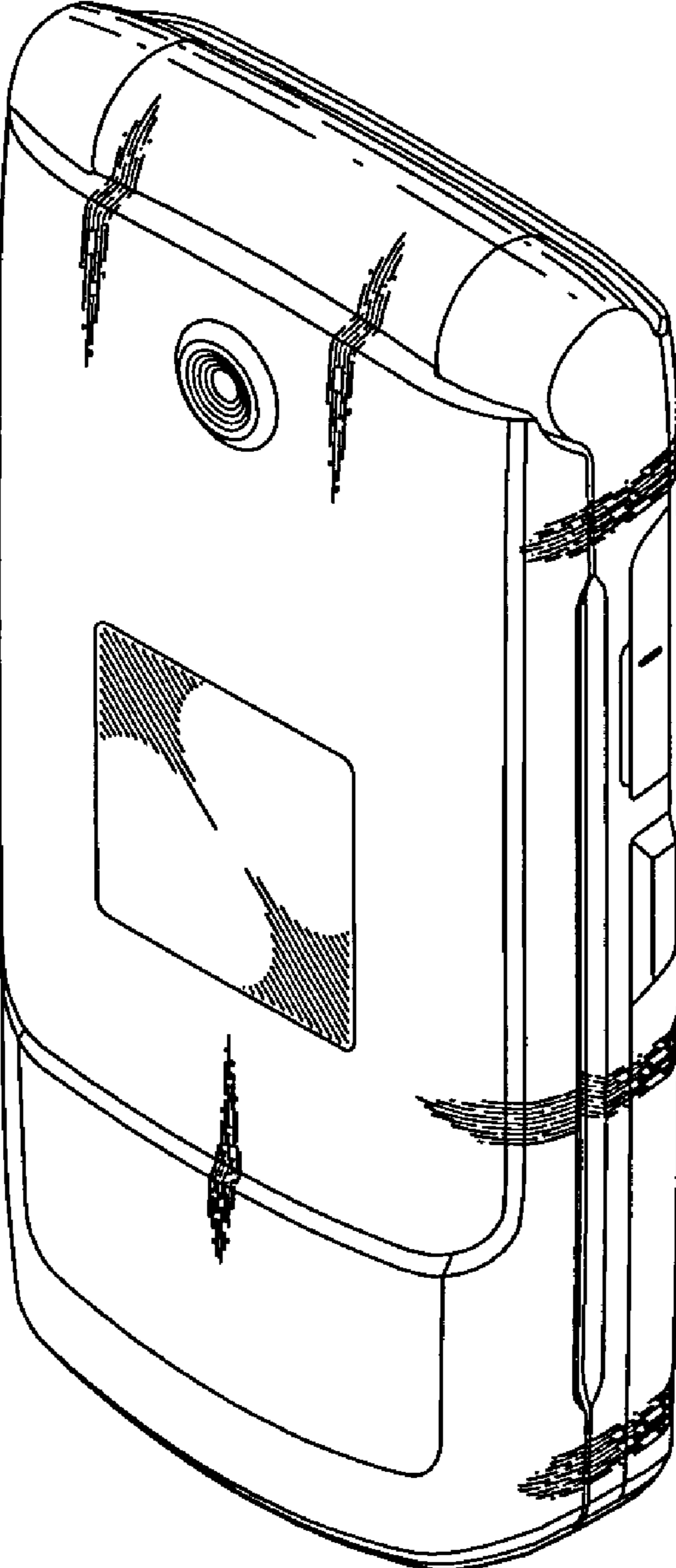

FIG. 2

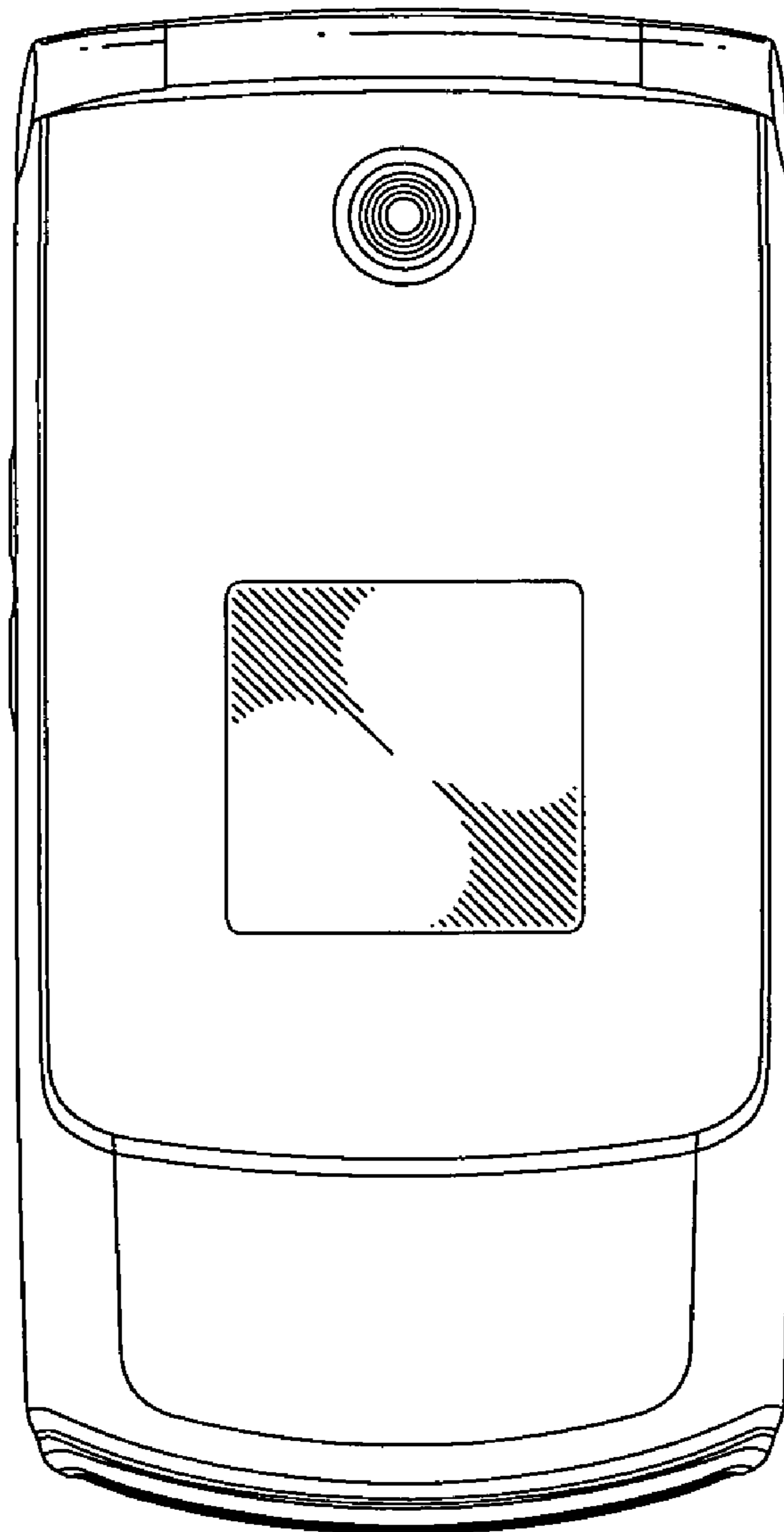

FIG. 3

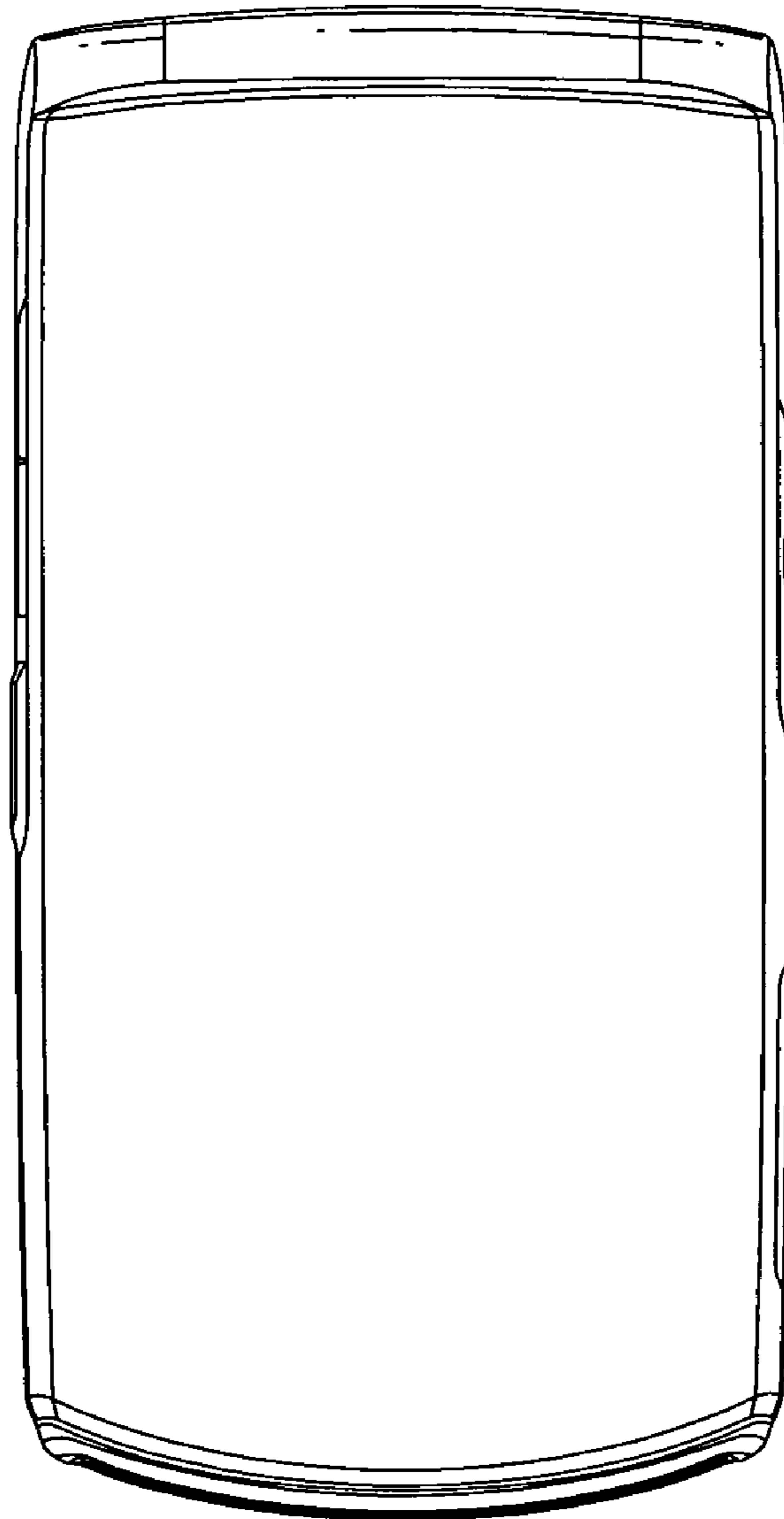

FIG. 4

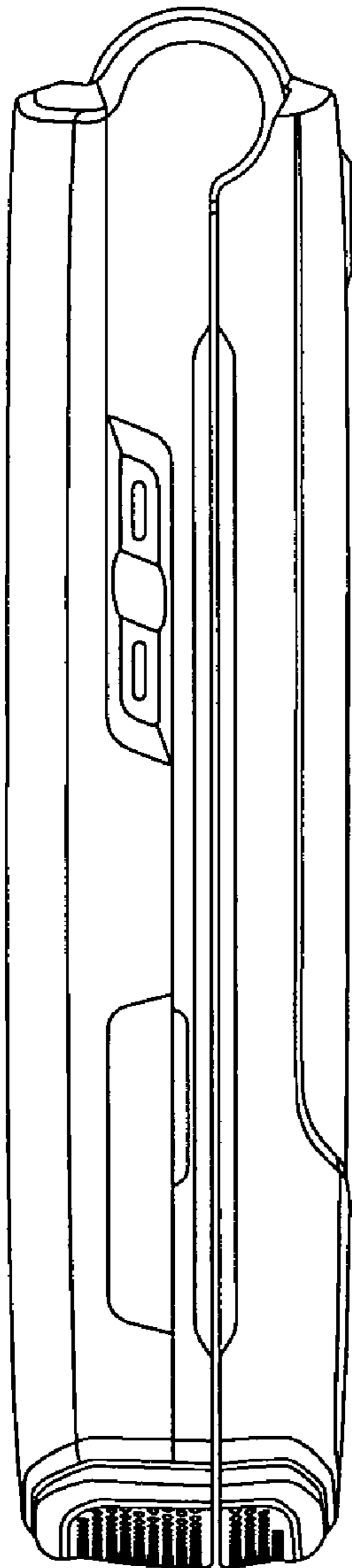

FIG. 5

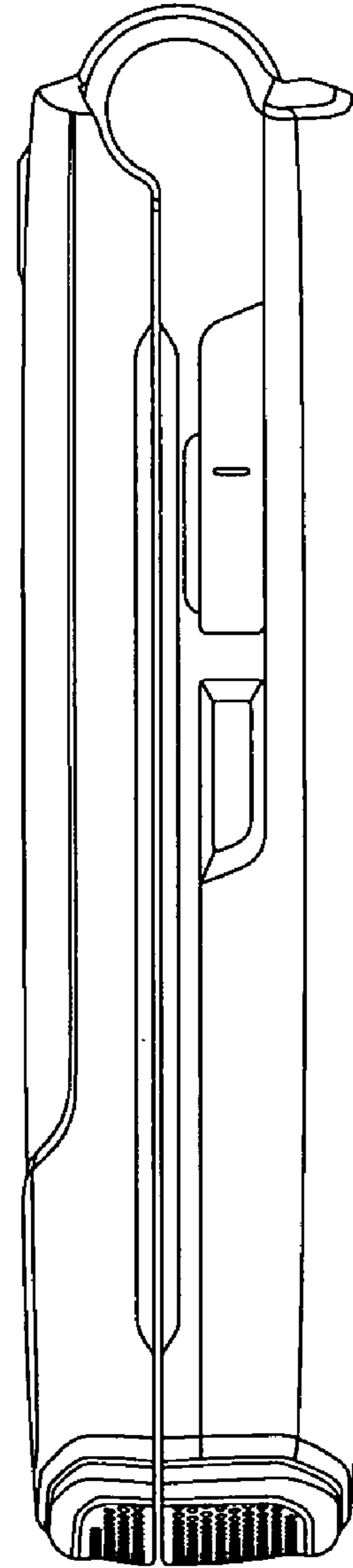

FIG. 6

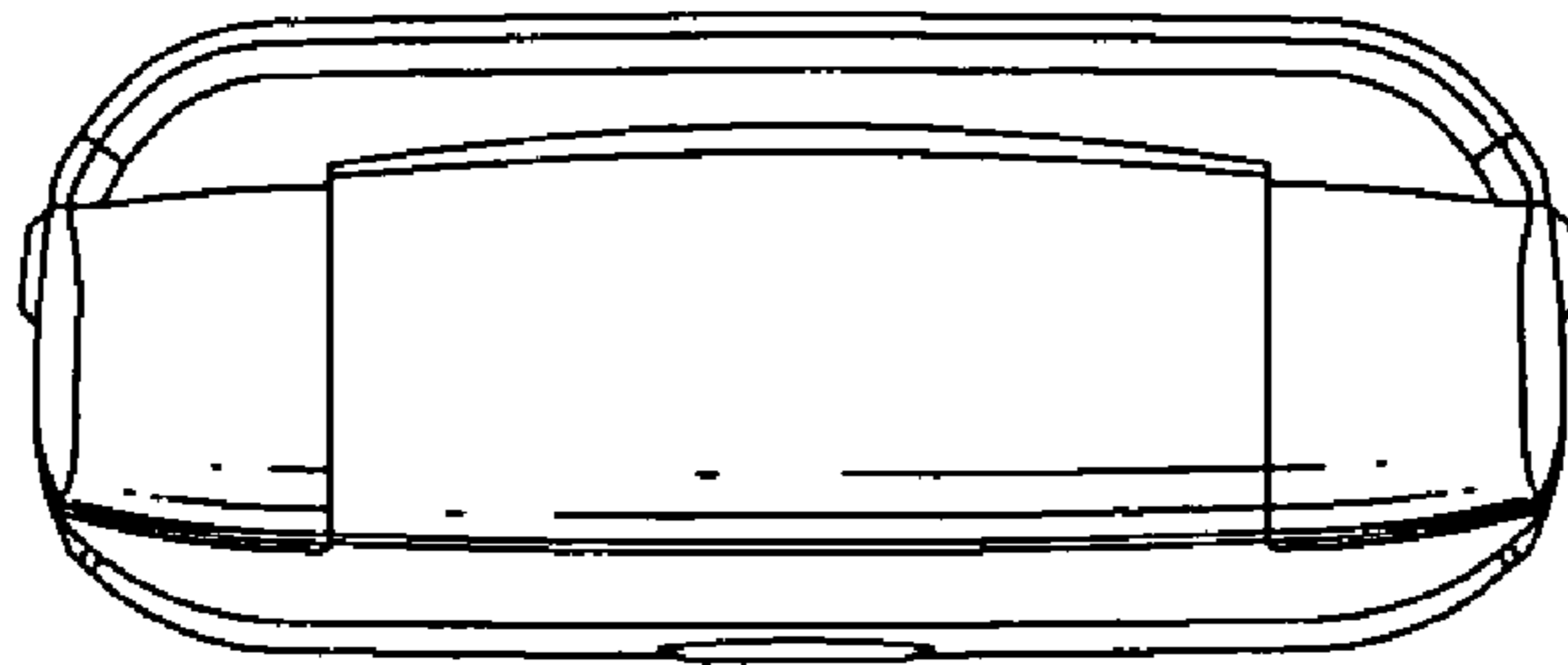

FIG. 7

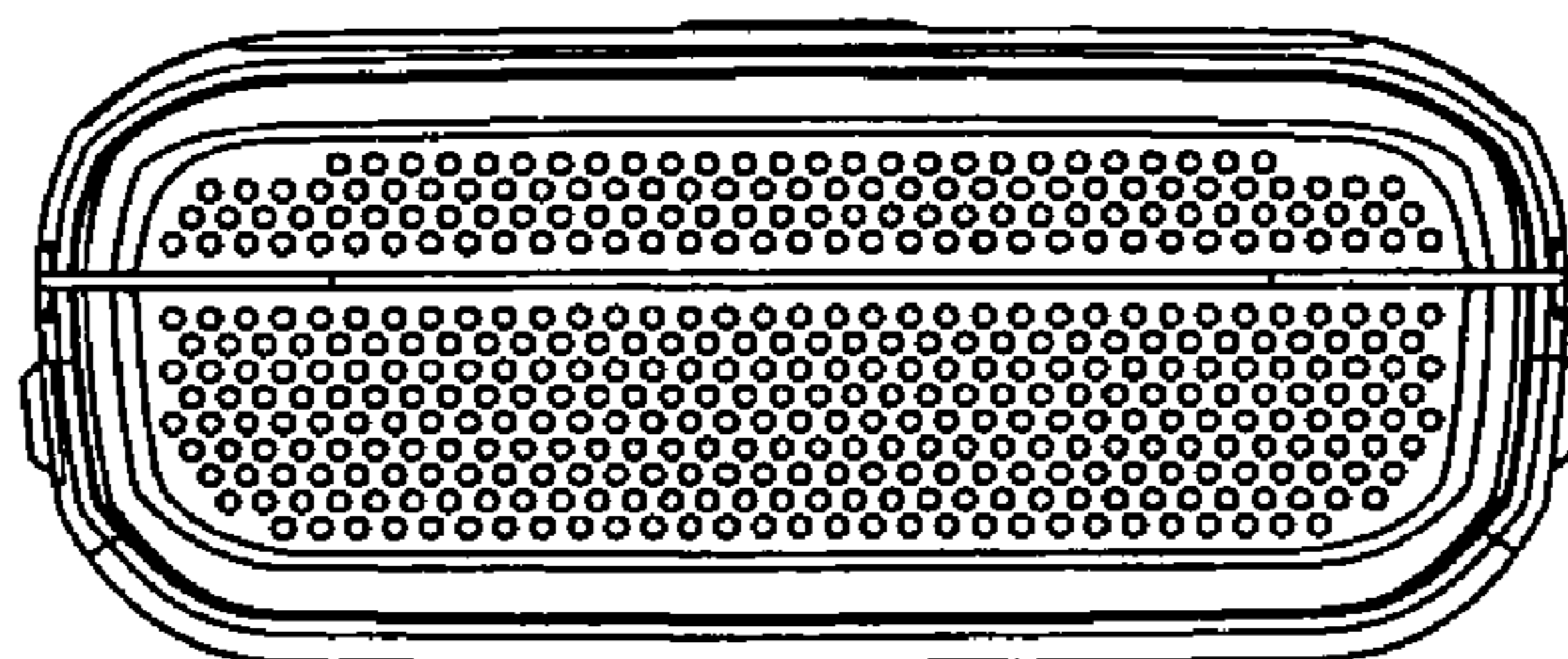

FIG. 8

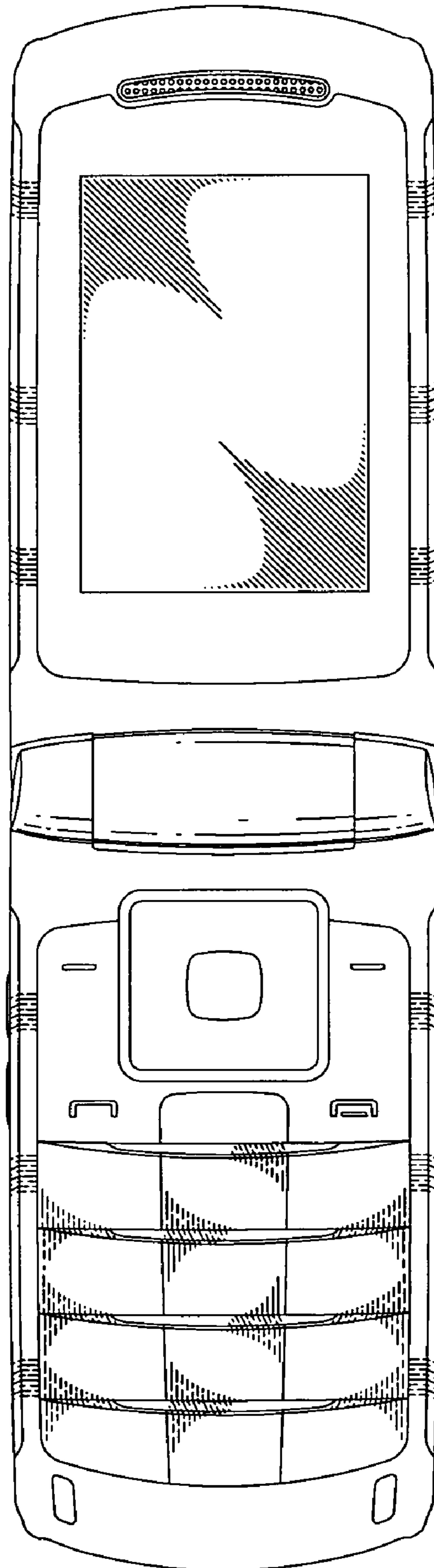

FIG. 9

