



US00D584974S

(12) **United States Design Patent**
Fukuda et al.

(10) **Patent No.:** **US D584,974 S**
(45) **Date of Patent:** **** Jan. 20, 2009**

(54) **ACTIVITY MONITOR**

Primary Examiner—Antoine D Davis

(75) Inventors: **Kansuke Fukuda**, Takatsuki (JP);
Masahiko Yumoto, Kyoto (JP); **Takashi Ono**, Kyoto (JP); **Takuto Serizawa**, Osaka (JP); **Takashi Shigeno**, Kawasaki (JP); **Kazuya Andachi**, Tokyo (JP)

(57) **CLAIM**

The ornamental design for an activity monitor, as shown and described.

(73) Assignee: **Omron Healthcare Co., Ltd.**, Kyoto (JP)

DESCRIPTION

(**) Term: **14 Years**

(21) Appl. No.: **29/318,530**

(22) Filed: **May 21, 2008**

(30) **Foreign Application Priority Data**

Nov. 27, 2007 (JP) 2007-032434
Nov. 27, 2007 (JP) 2007-032435
Nov. 27, 2007 (JP) 2007-032436

FIG. 1 is a front, top, and right side perspective view of a first embodiment of an activity monitor showing our new design; FIG. 2 is a rear, bottom, and left side perspective view thereof; FIG. 3 is a front elevational view thereof; FIG. 4 is a rear elevational view thereof; FIG. 5 is a top plan view thereof; FIG. 6 is a bottom plan view thereof; FIG. 7 is a right side elevational view thereof; FIG. 8 is a left side elevational view thereof; FIG. 9 is a front, top, and right side perspective view of a second embodiment of an activity monitor showing our new design; FIG. 10 is a rear, bottom, and left side perspective view thereof; FIG. 11 is a front elevational view thereof; FIG. 12 is a rear elevational view thereof; FIG. 13 is a top plan view thereof; FIG. 14 is a bottom plan view thereof; FIG. 15 is a right side elevational view thereof; and, FIG. 16 is a left side elevational view thereof.

(51) **LOC (9) Cl.** **10-04**

(52) **U.S. Cl.** **D10/70**

(58) **Field of Classification Search** D10/78;
235/95 C, 105; 377/5.24, 2.26; 702/155,
702/160, 176

See application file for complete search history.

(56) **References Cited**

U.S. PATENT DOCUMENTS

5,673,691 A * 10/1997 Abrams et al. 600/300
5,890,128 A * 3/1999 Diaz et al. 705/2
D543,877 S * 6/2007 Bhavnani D10/70
D545,226 S 6/2007 Azuma
D545,700 S * 7/2007 Man D10/70
D573,906 S * 7/2008 Maki et al. D10/70

* cited by examiner

1 Claim, 6 Drawing Sheets

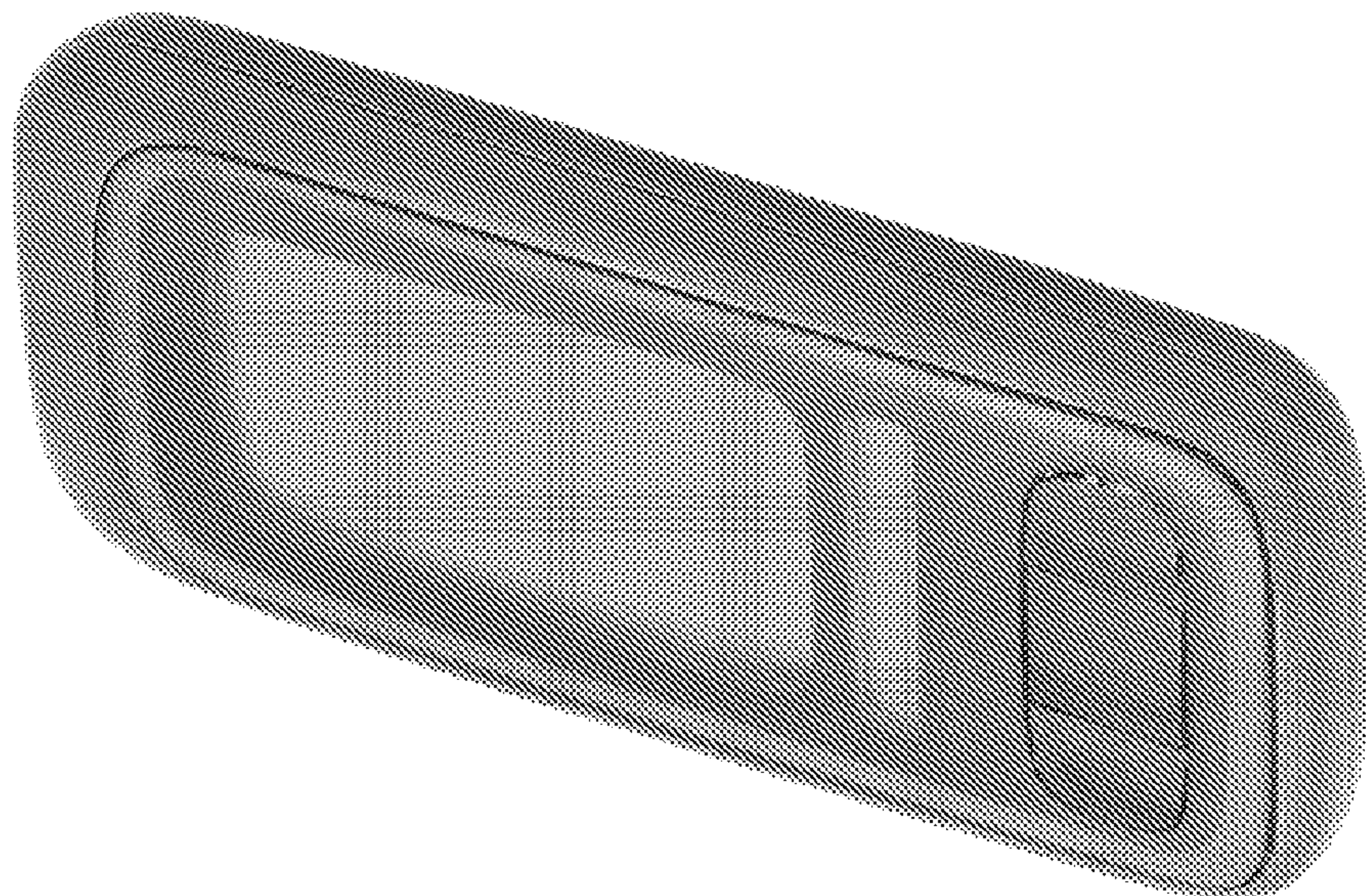

Fig. 1

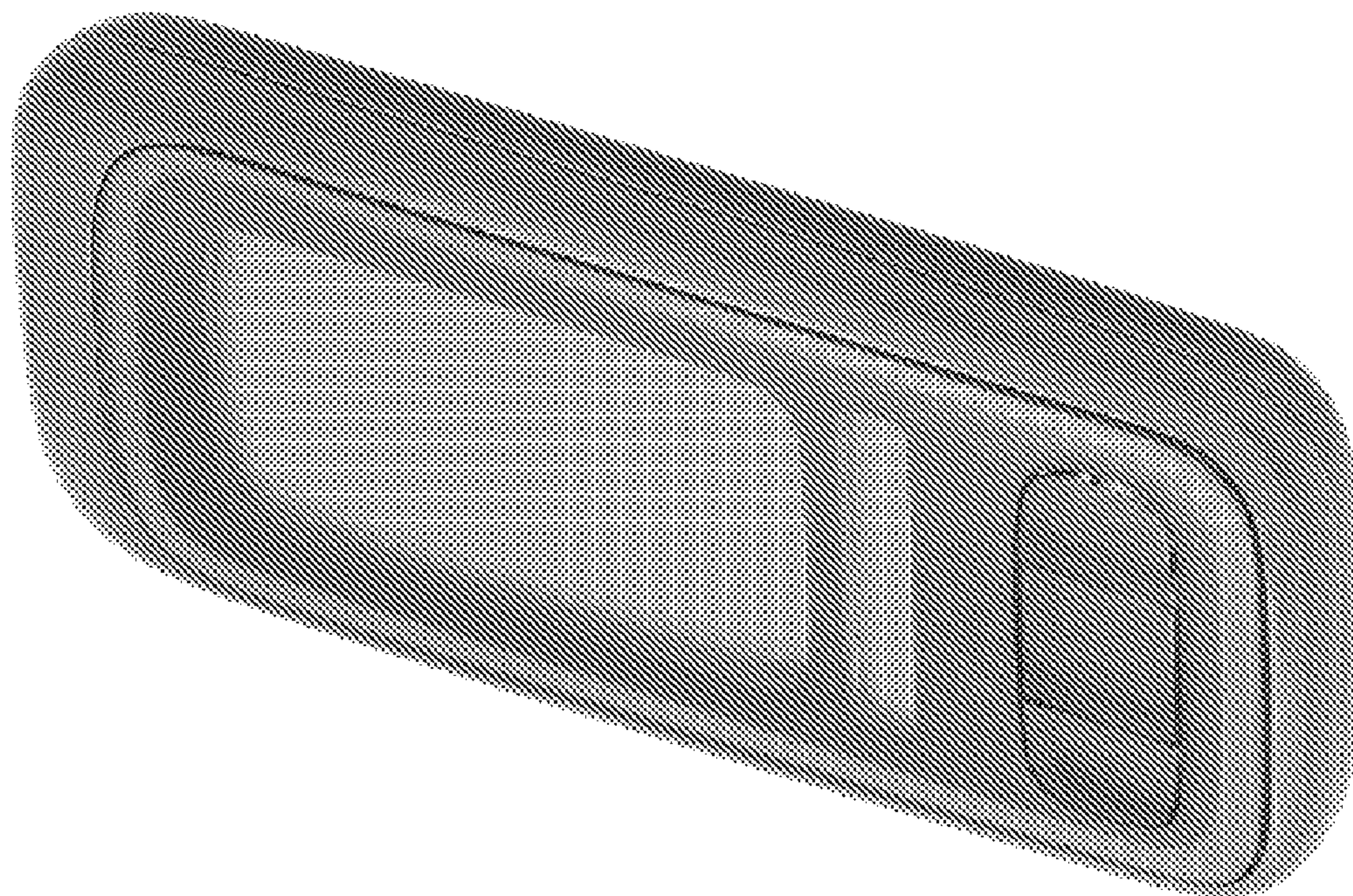

Fig. 2

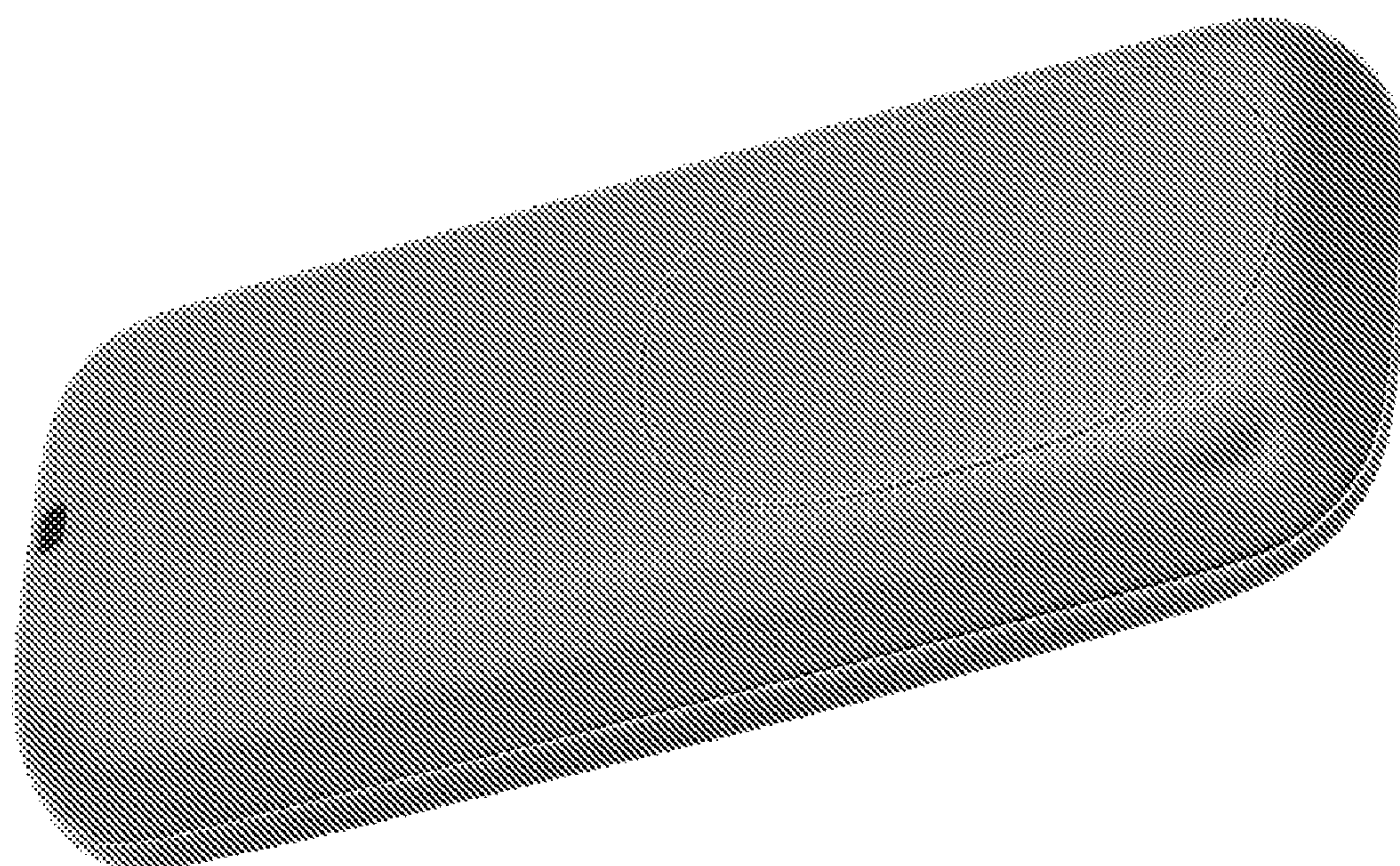

Fig. 3

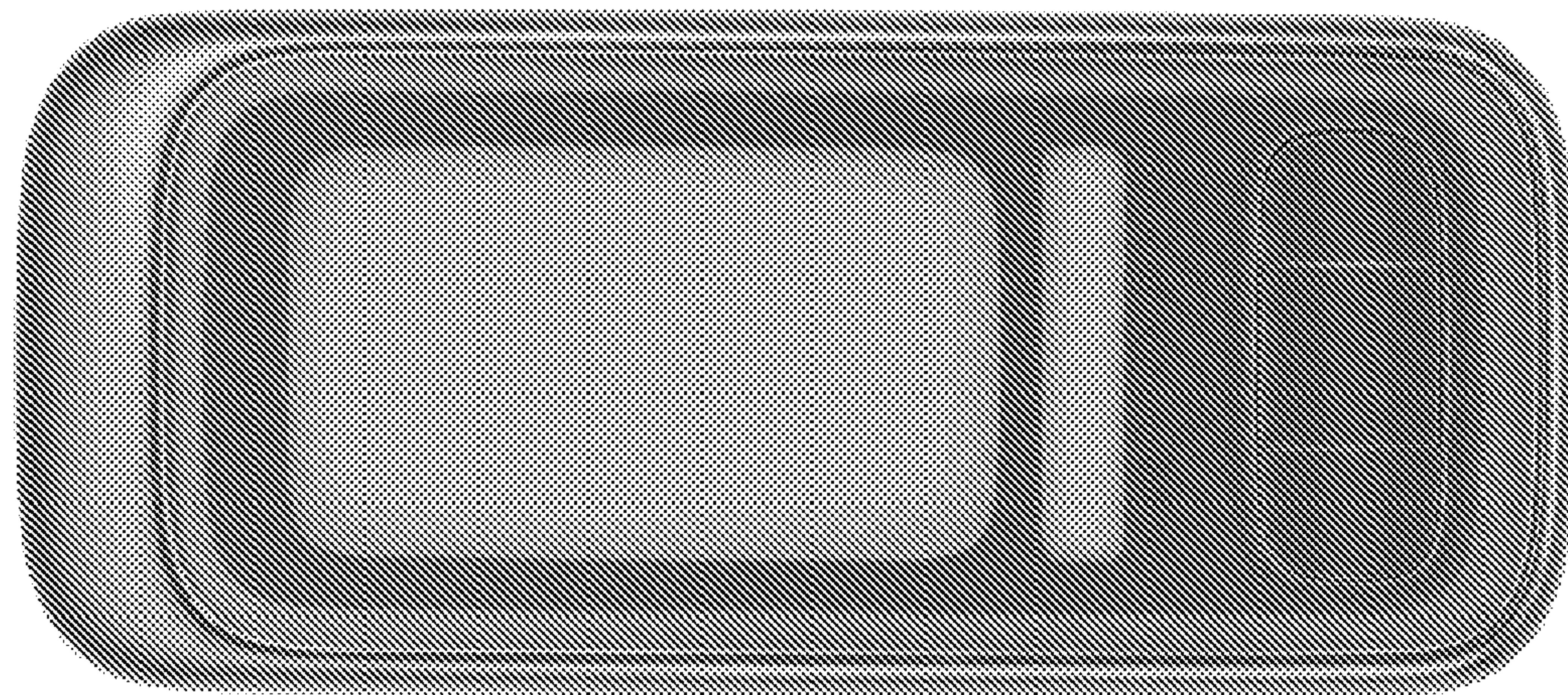

Fig. 4

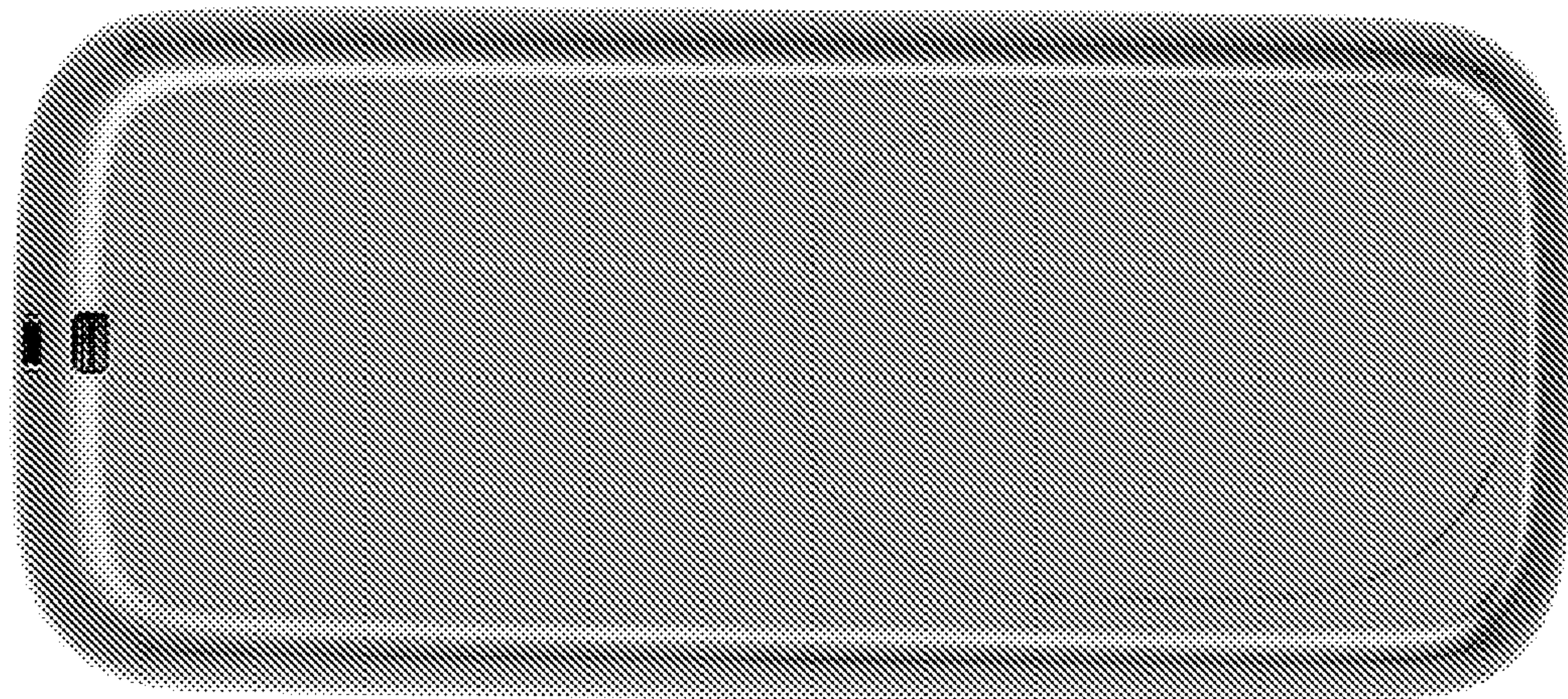

Fig. 5

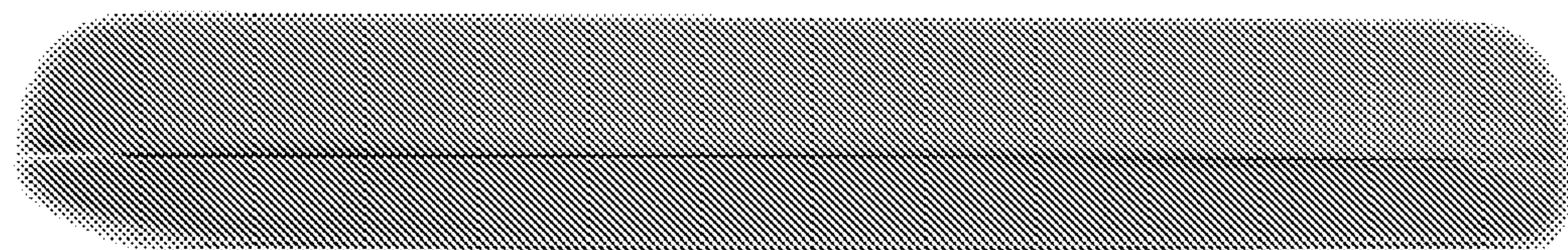

Fig. 6

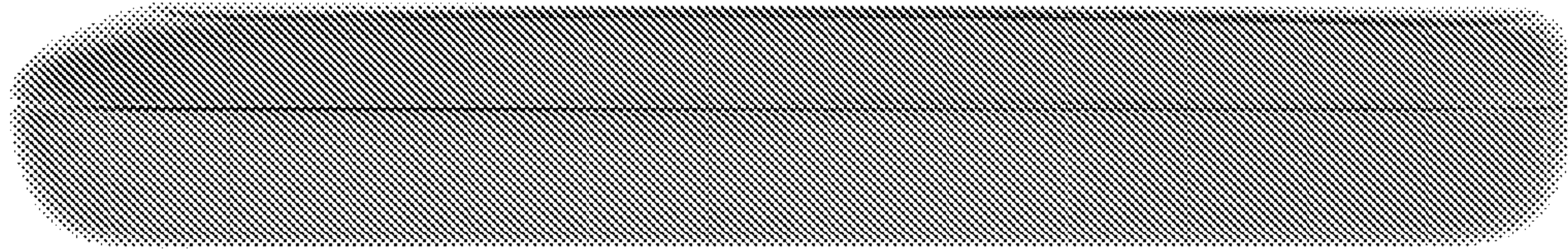

Fig. 7

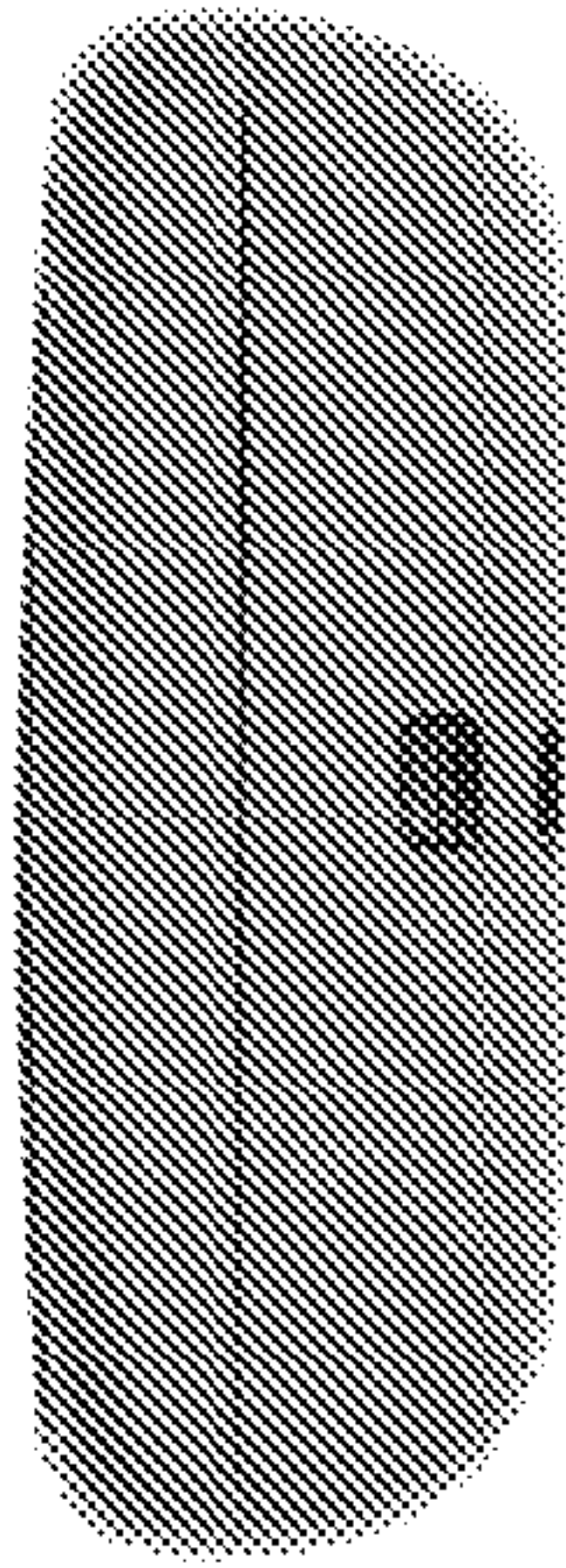

Fig. 8

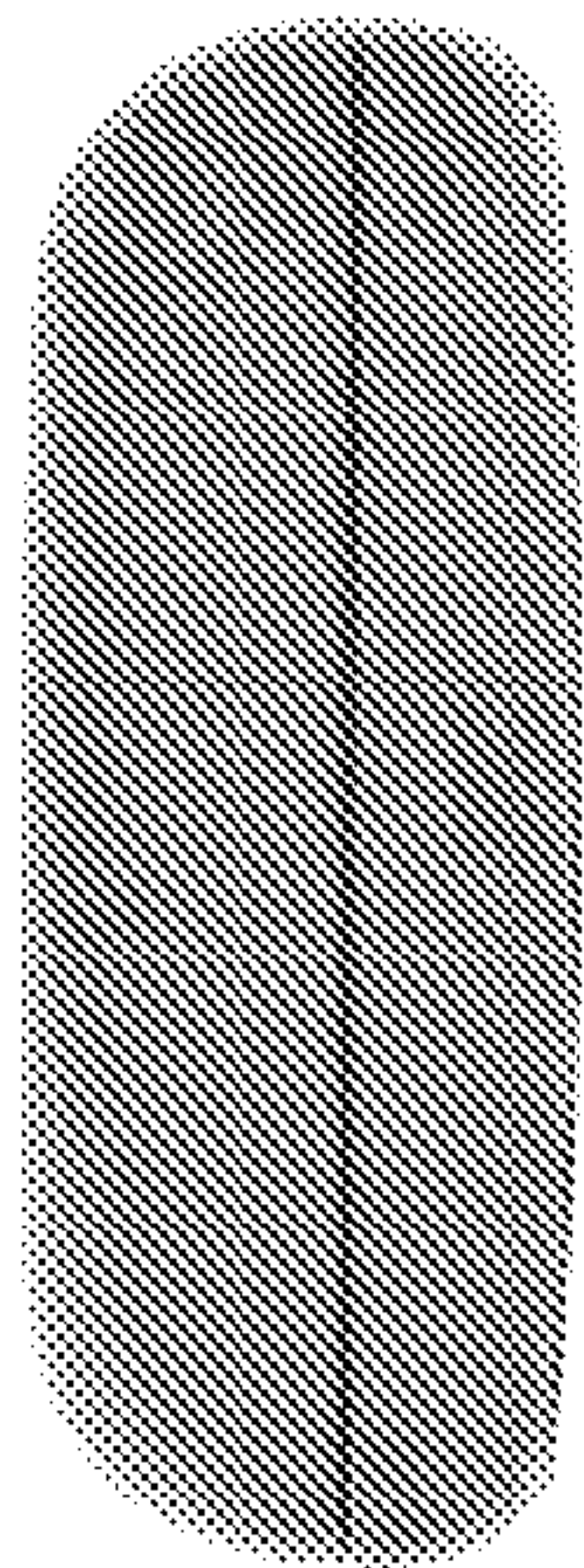

Fig. 9

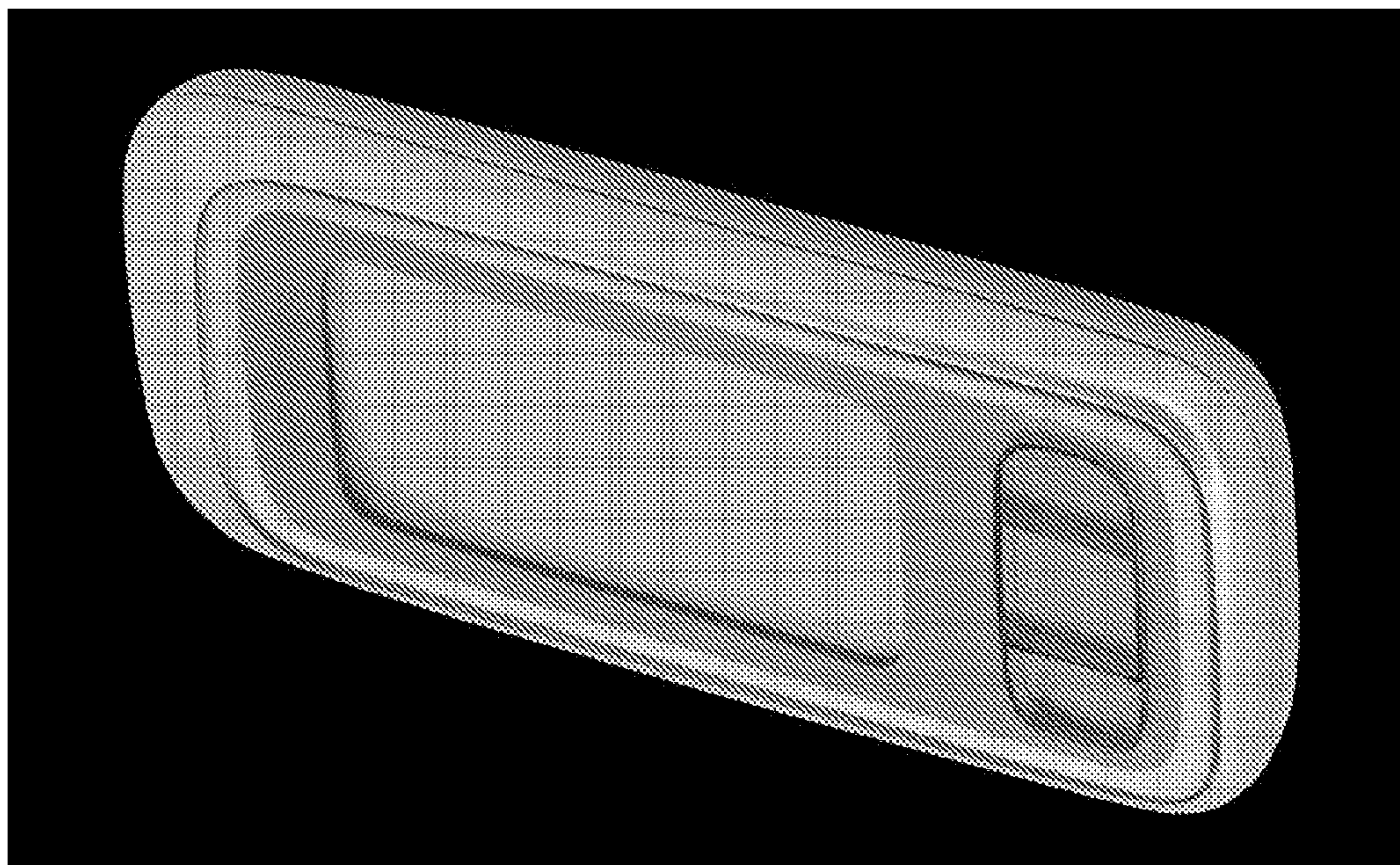

Fig. 10

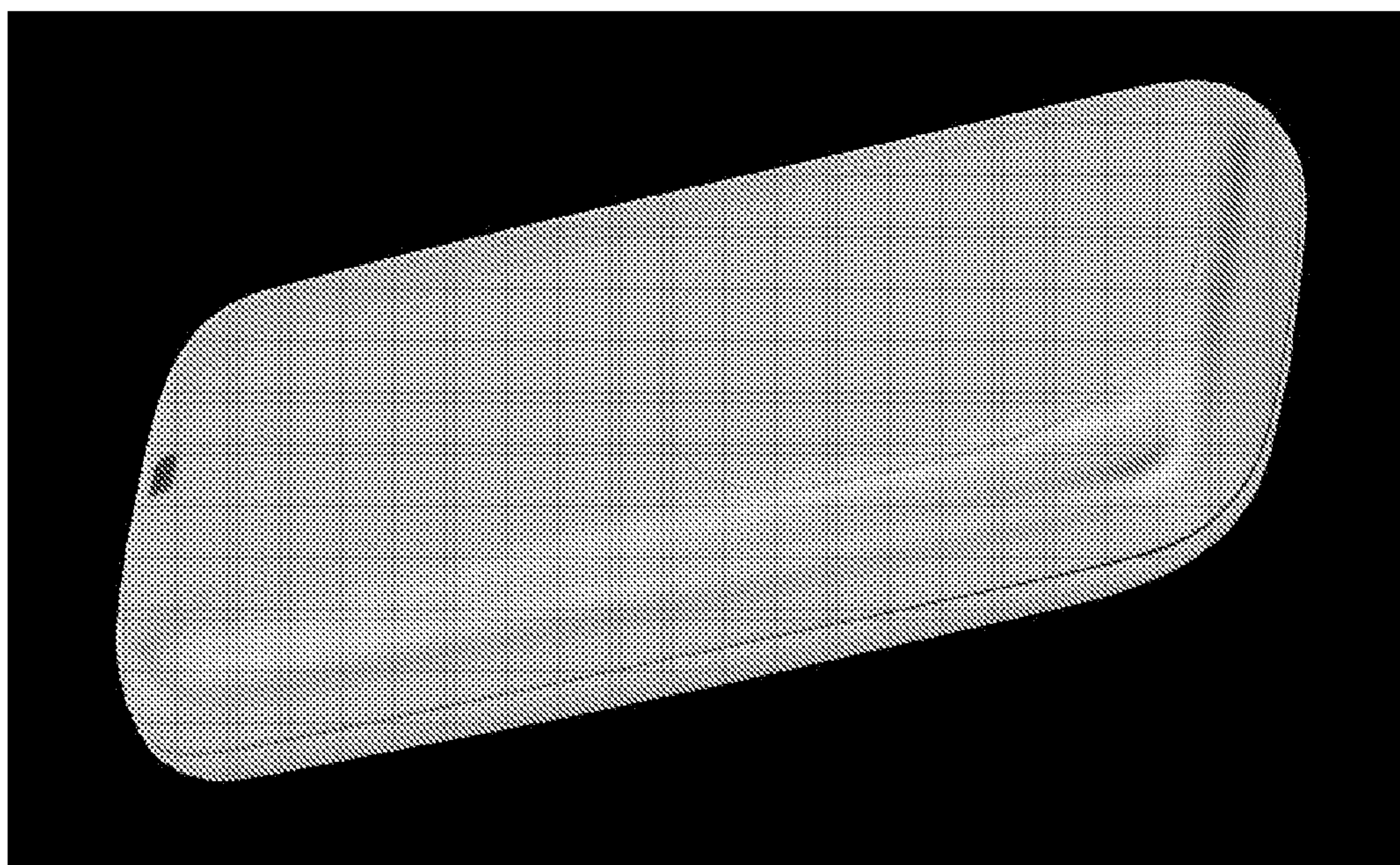

Fig. 11

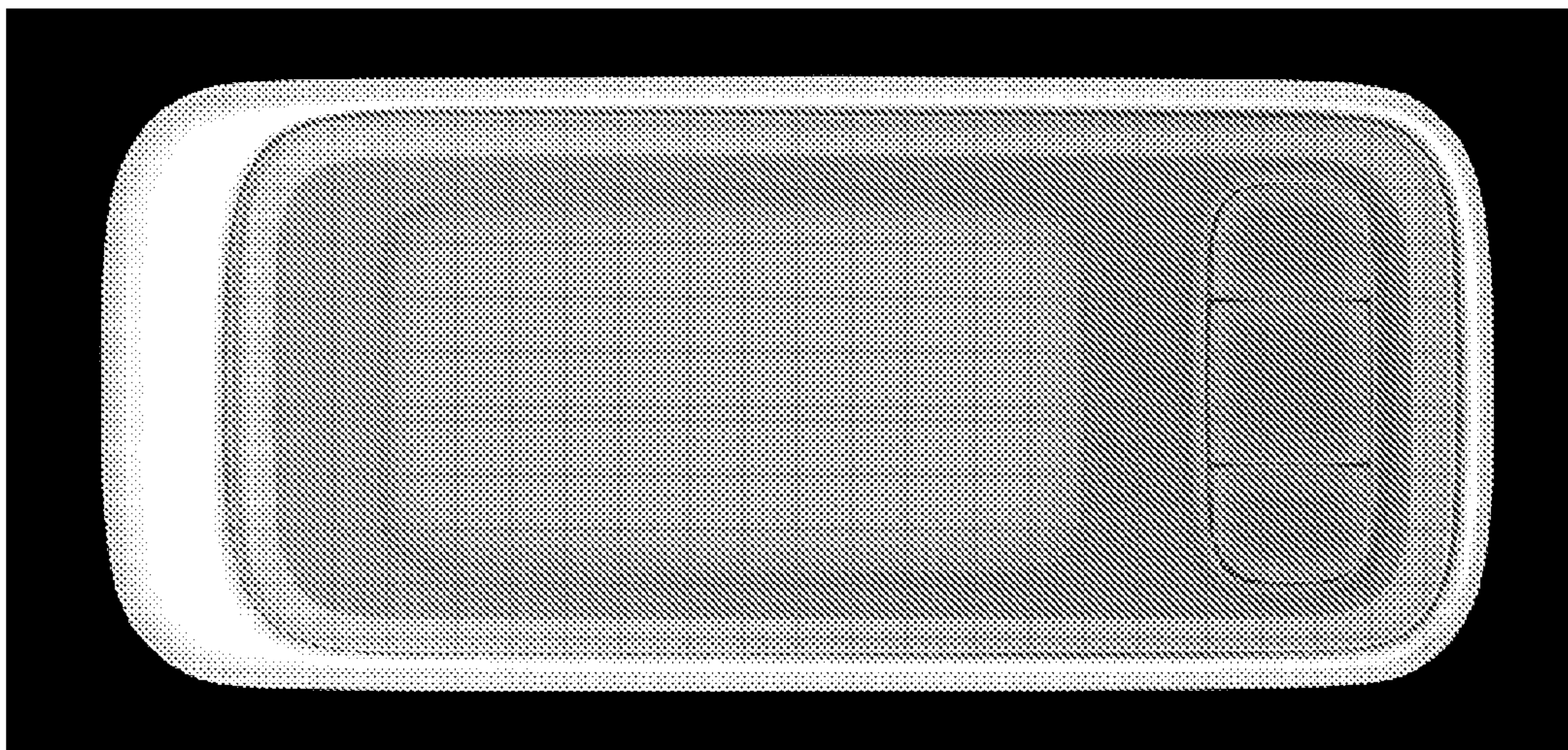

Fig. 12

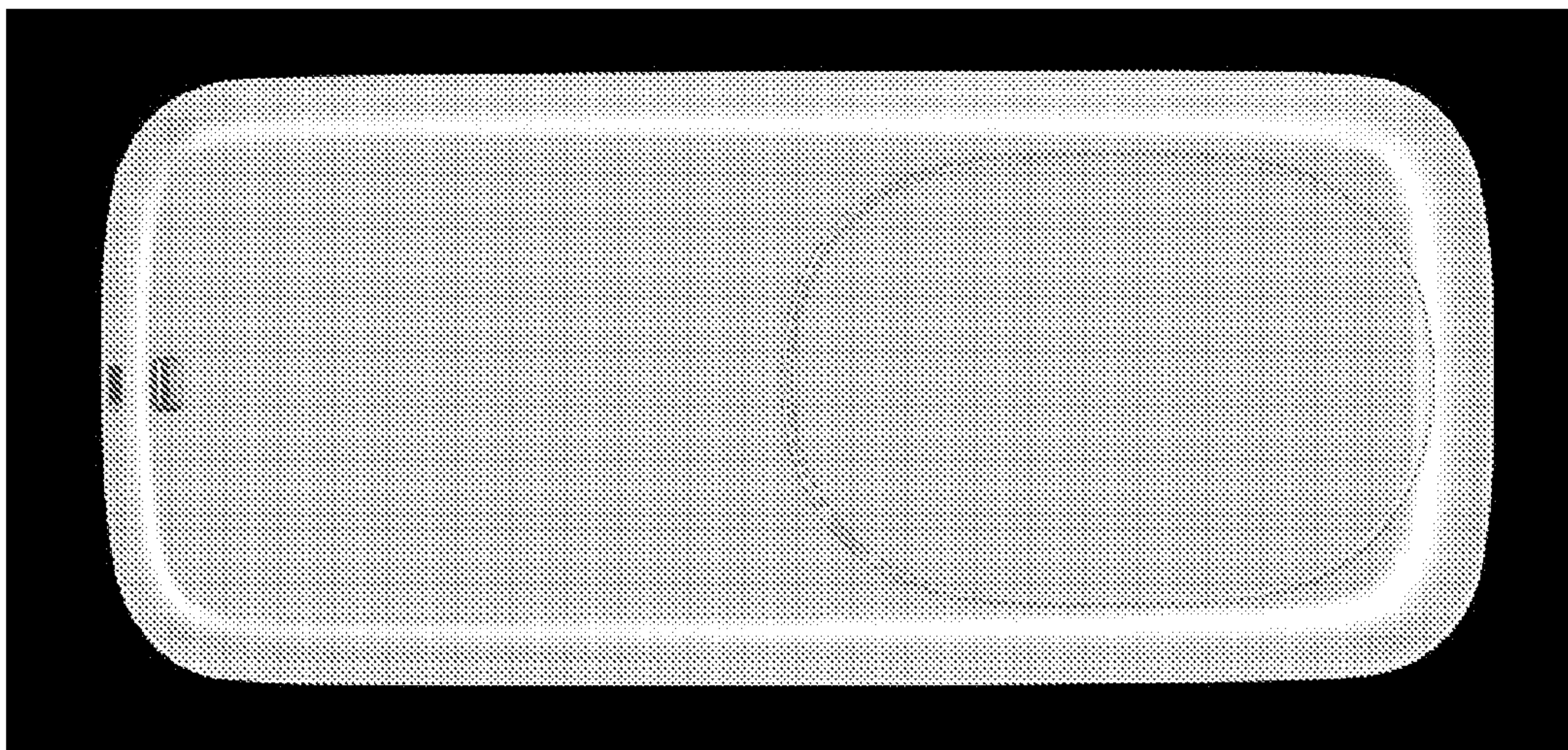

Fig. 13

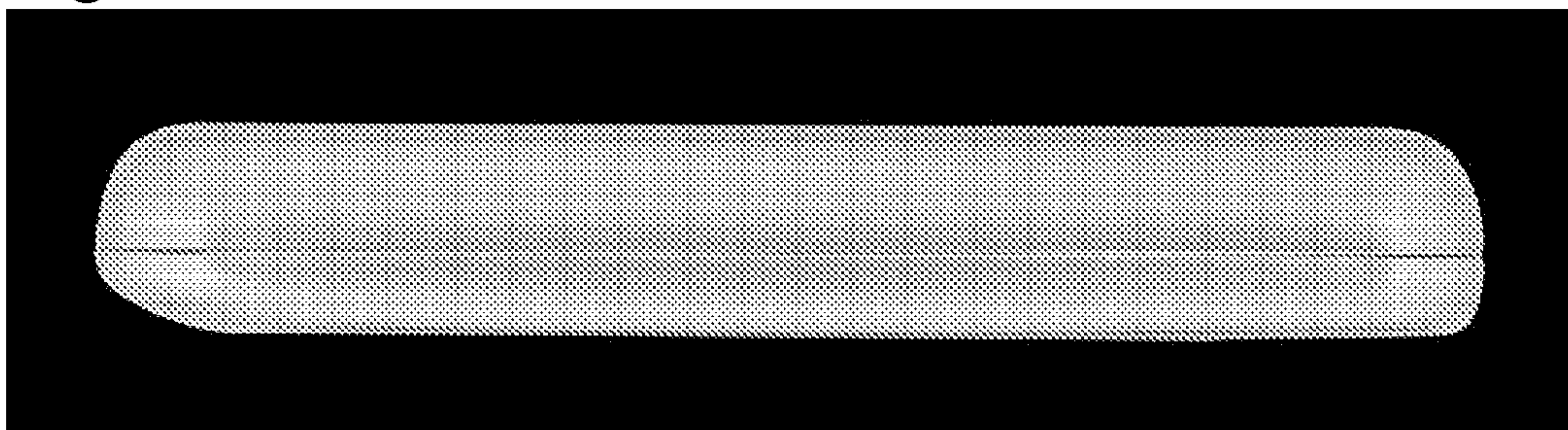

Fig. 14

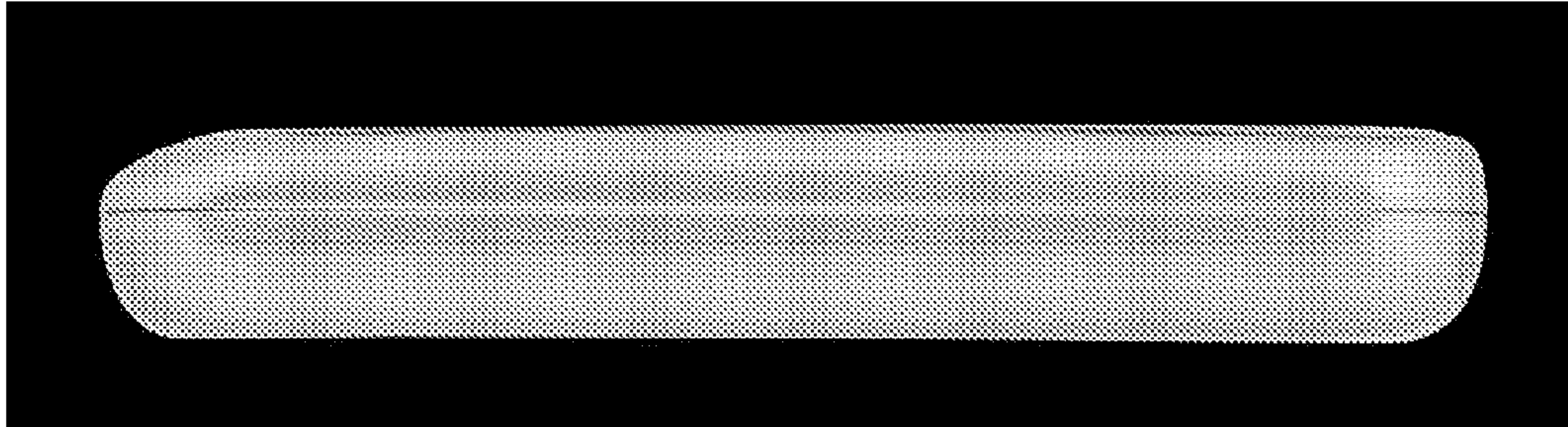

Fig. 15

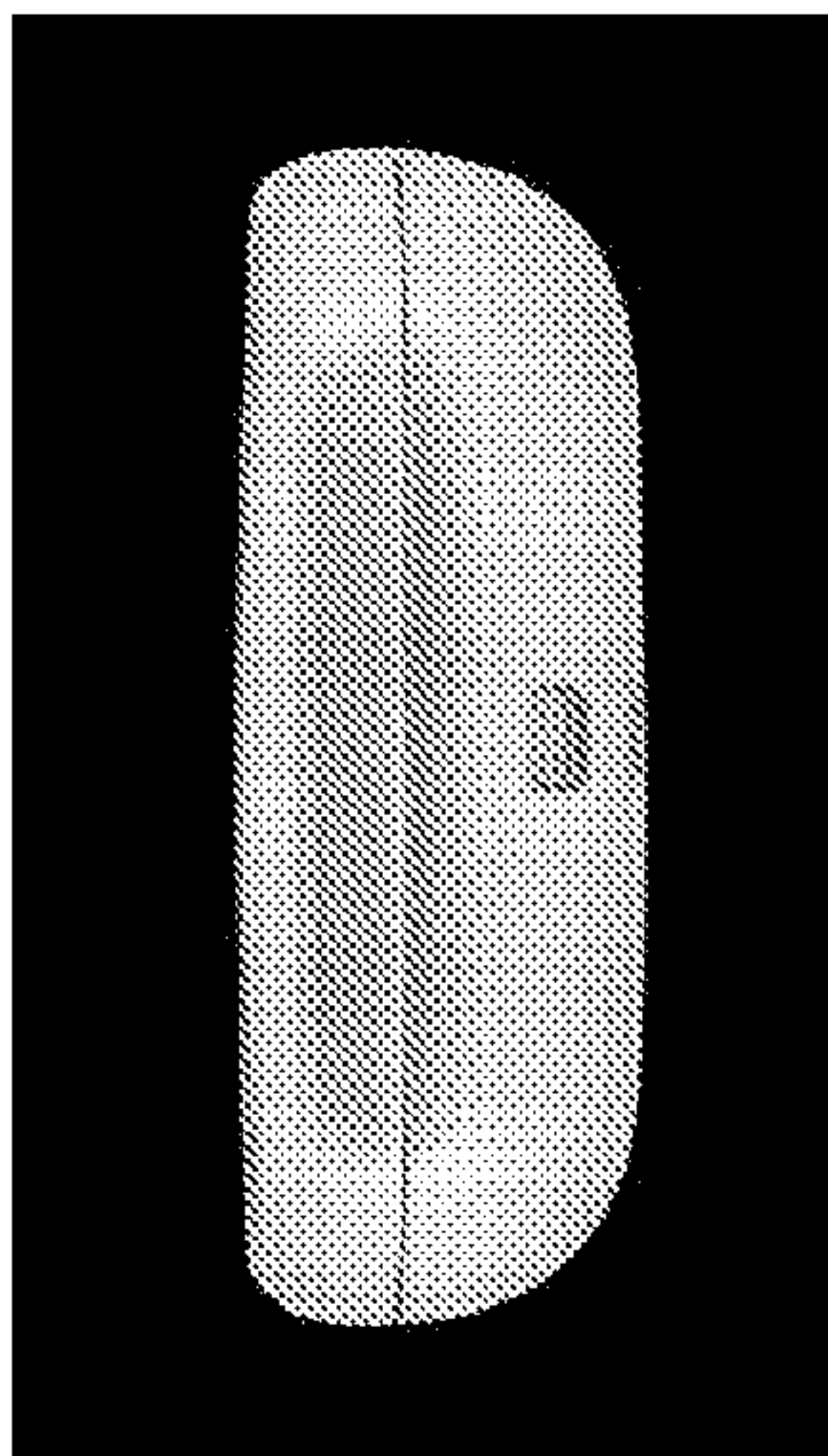

Fig. 16

