



US00D584823S

(12) **United States Design Patent**
Conlon

(10) **Patent No.:** **US D584,823 S**
(45) **Date of Patent:** **** Jan. 13, 2009**

(54) **TEETHER**

(76) **Inventor:** **Laurie Conlon**, 4615 SE. Manatee Ter.,
Stuart, FL (US) 34997

(**) **Term:** **14 Years**

(21) **Appl. No.:** **29/305,380**

(22) **Filed:** **Mar. 19, 2008**

(51) **LOC (9) Cl.** **24-04**

(52) **U.S. Cl.** **D24/194**

(58) **Field of Classification Search** D24/154,
D24/193-199, 200, 211, 214; D30/160;
606/234-236; 215/11.1-11.6; 604/93.01;
D4/104-107, 112, 119, 128, 136-138; D28/7;
601/139-141, 154

See application file for complete search history.

(56) **References Cited**

U.S. PATENT DOCUMENTS

58,186	A *	9/1866	Bourguard	604/93.01
1,660,095	A *	2/1928	Schiele	601/139
D187,591	S *	4/1960	Diener	D24/154
3,892,243	A *	7/1975	Bell	606/234
D293,472	S *	12/1987	Chrones et al.	D24/211
5,154,318	A *	10/1992	Lampard	222/105
5,230,356	A *	7/1993	Villas	132/329
5,284,490	A *	2/1994	Green	606/235

D383,307	S *	9/1997	Klein et al.	D4/105
5,711,759	A *	1/1998	Smith et al.	601/139
6,863,681	B2 *	3/2005	Dickerson	606/235
D522,658	S *	6/2006	Schiavoni	D24/194
7,260,862	B1 *	8/2007	DeFilippis	15/22.1
D566,400	S *	4/2008	Phillips	D4/107

* cited by examiner

Primary Examiner—Robert M Spear

Assistant Examiner—Susan E Krakower

(74) *Attorney, Agent, or Firm*—McHale & Slavin, P.A.

(57) **CLAIM**

The ornamental design for a teether, as shown and described.

DESCRIPTION

FIG. 1 is a top perspective view of the teether of the instant invention;

FIG. 2 is a bottom perspective view thereof;

FIG. 3 is a top view thereof;

FIG. 4 is a bottom view thereof;

FIG. 5 is a left side view thereof;

FIG. 6 is a right side view thereof;

FIG. 7 is a front view thereof; and,

FIG. 8 is a rear view thereof.

1 Claim, 5 Drawing Sheets

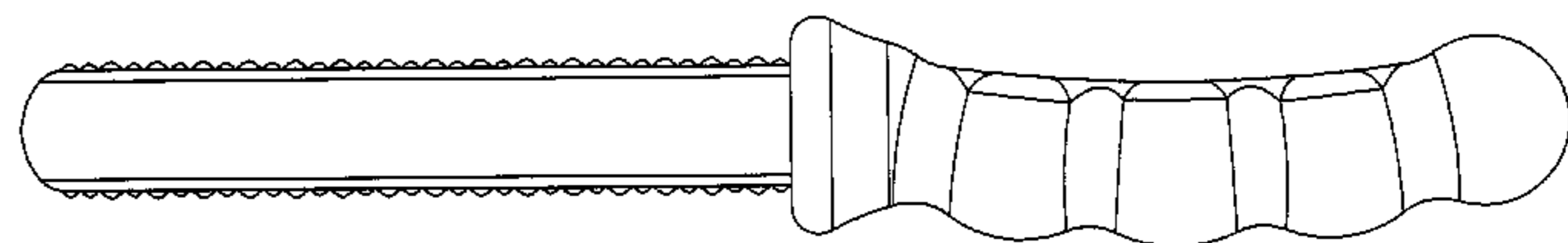
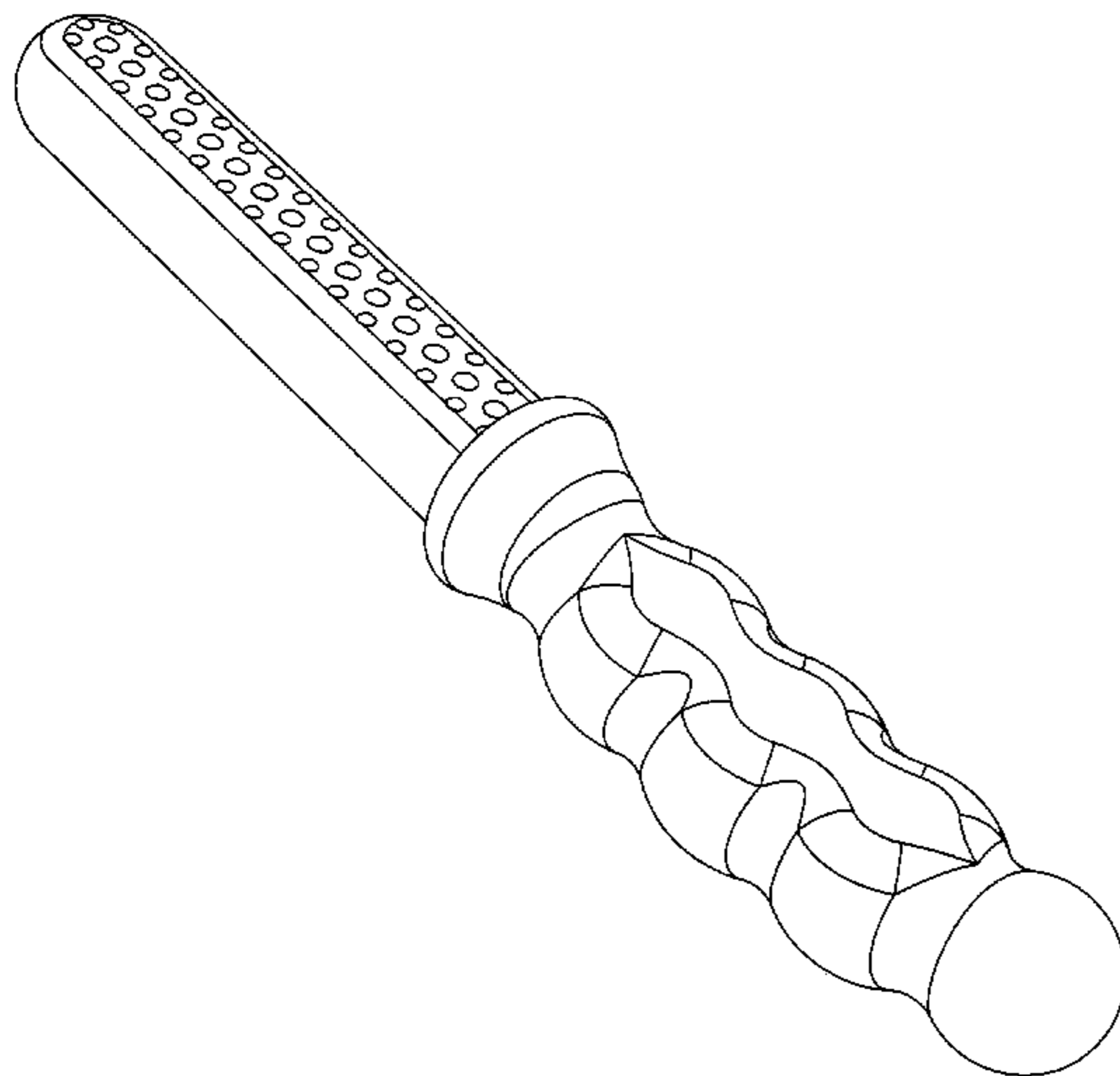

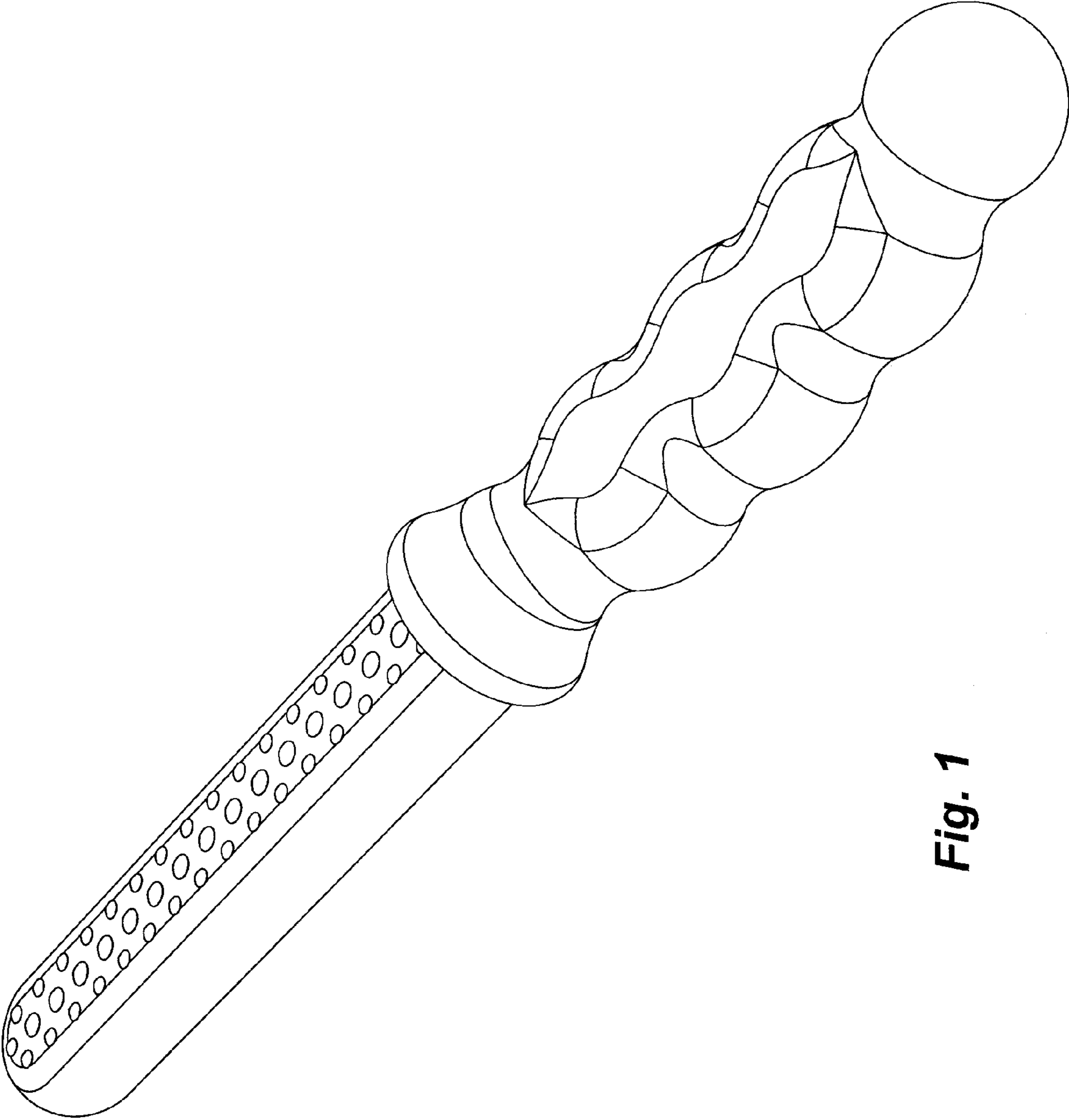

Fig. 1

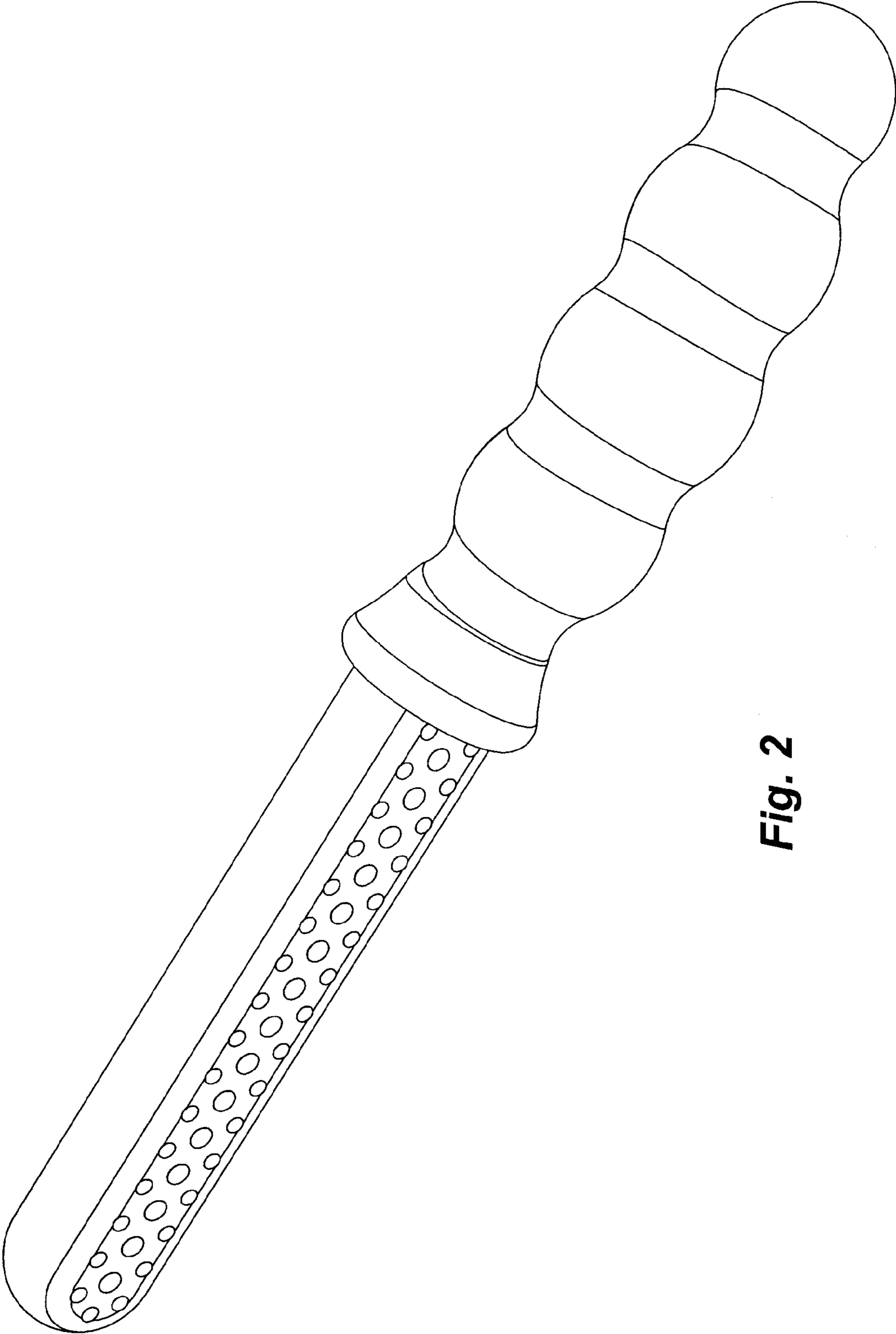

Fig. 2

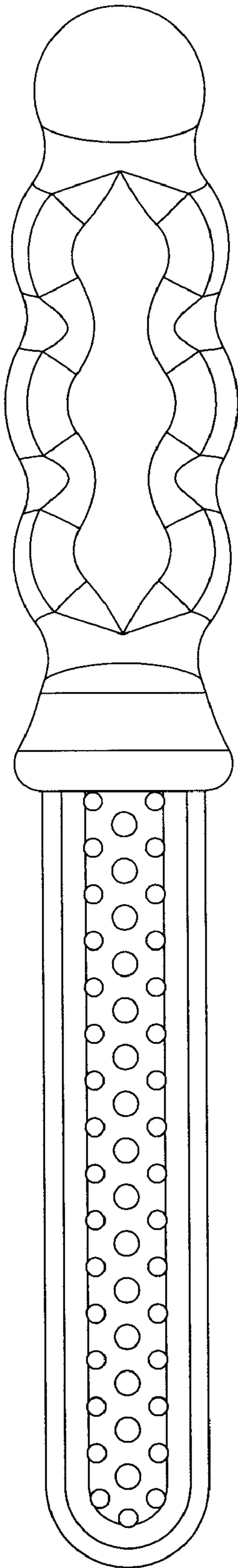

Fig. 3

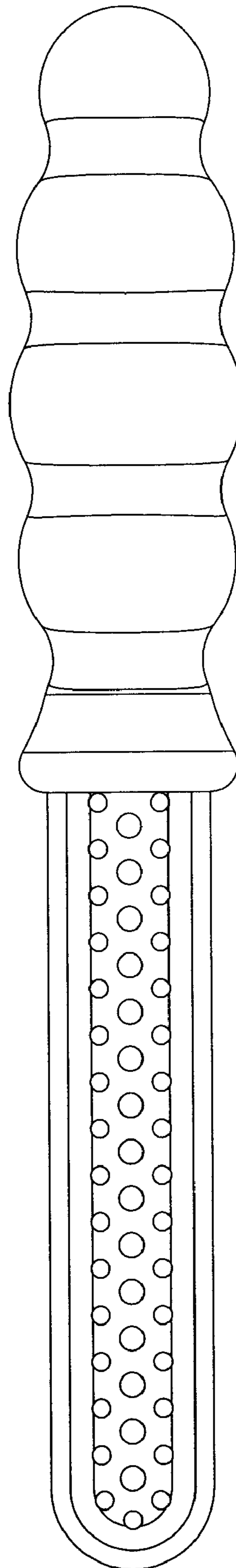

Fig. 4

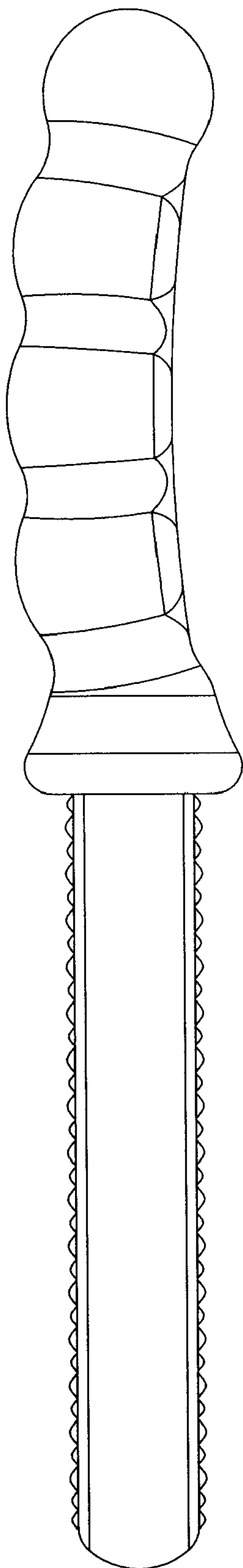

Fig. 5

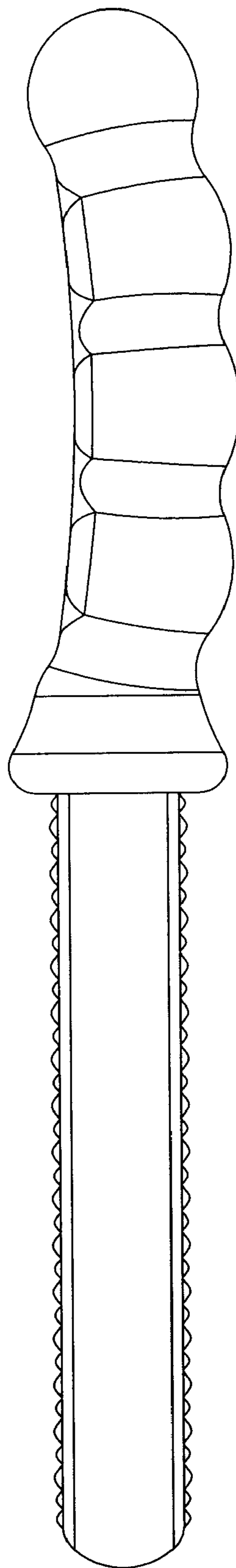

Fig. 6

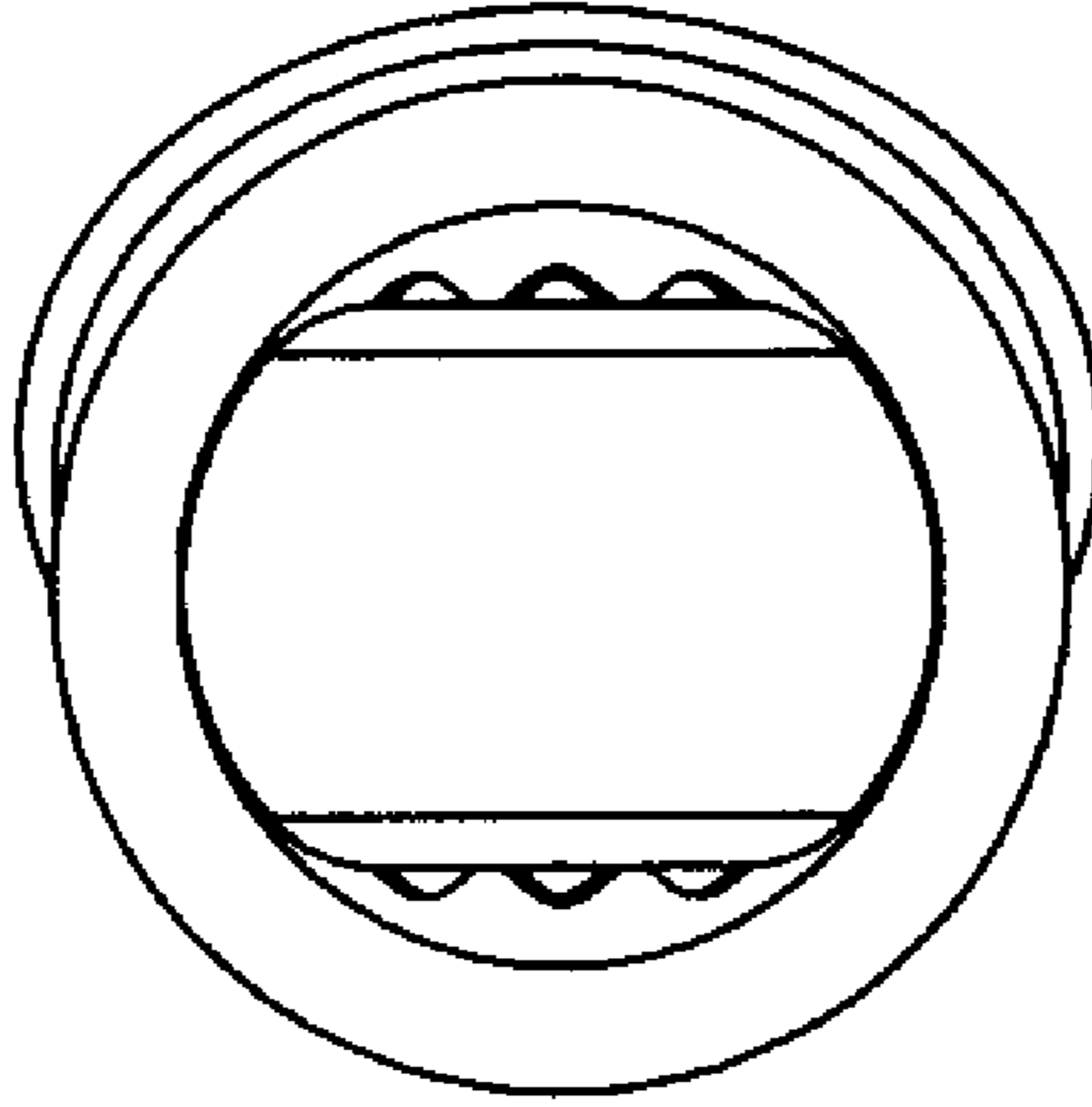

Fig. 7

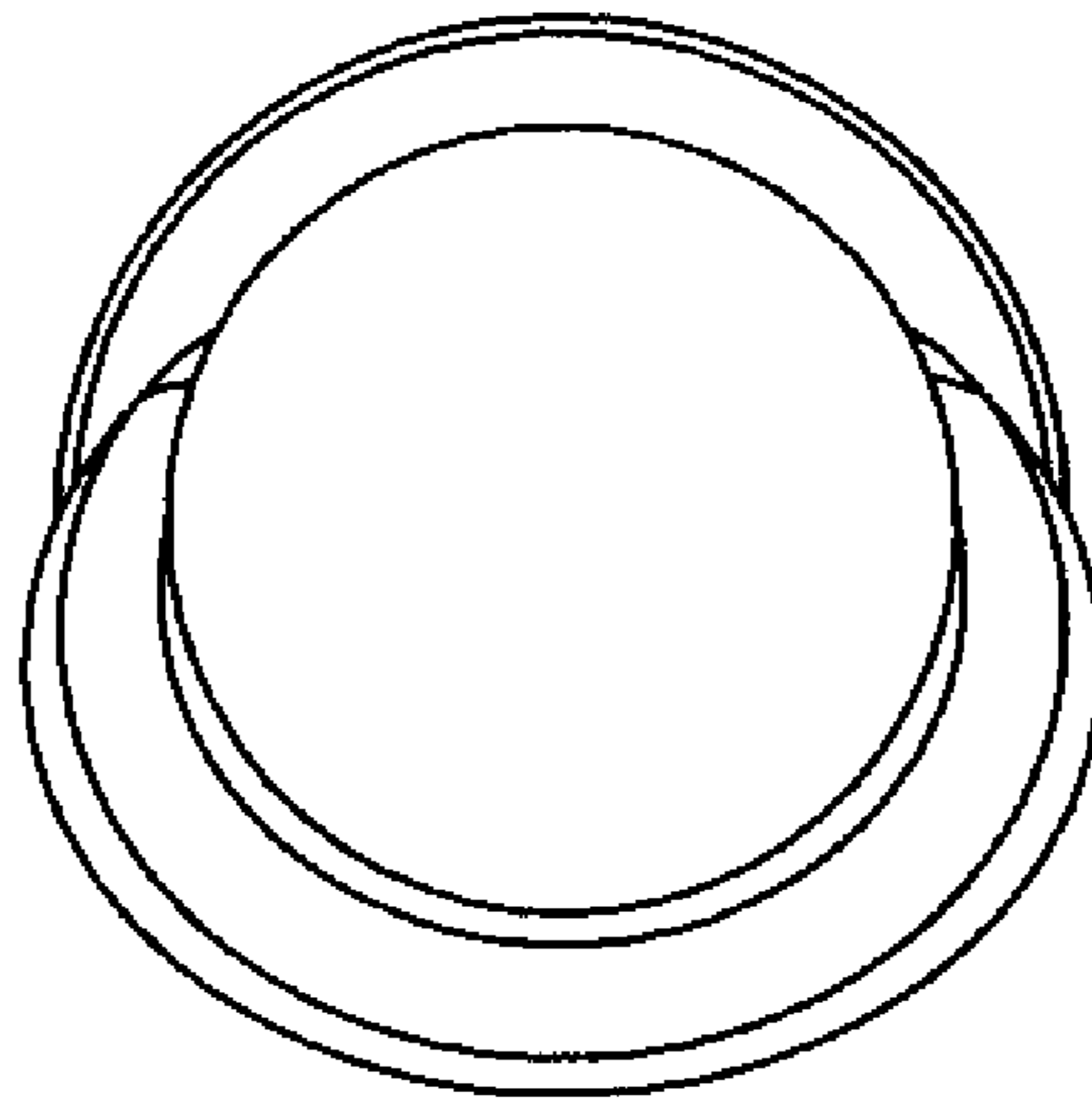

Fig. 8