



US00D584812S

(12) **United States Design Patent**
Ries

(10) **Patent No.:** **US D584,812 S**
(45) **Date of Patent:** **** Jan. 13, 2009**

(54) **MEDICAL PUMP**

(75) Inventor: **Wolfgang Ries**, Linkenheim (DE)

(73) Assignee: **joimax GmbH**, Karlsruhe (DE)

(**) Term: **14 Years**

(21) Appl. No.: **29/270,705**

(22) Filed: **Jan. 3, 2007**

(30) **Foreign Application Priority Data**

Jul. 7, 2006	(EM)	000558093-0001
Jul. 7, 2006	(EM)	000558093-0002
Jul. 7, 2006	(EM)	000558093-0003
Jul. 7, 2006	(EM)	000558093-0004
Jul. 7, 2006	(EM)	000558093-0005

(51) **LOC (9) Cl.** **24-02**

(52) **U.S. Cl.** **D24/111**

(58) **Field of Classification Search** D24/111,
D24/108, 169, 186; 604/155, 154; 128/DIG. 1,
128/DIG. 2

See application file for complete search history.

(56) **References Cited**

U.S. PATENT DOCUMENTS

D311,062 S *	10/1990	Nelson	D24/186
5,507,734 A *	4/1996	Everett et al.	604/320
D412,977 S *	8/1999	Hayamizu	D24/107

D420,738 S *	2/2000	Carter et al.	D24/111
D423,665 S *	4/2000	Herbst et al.	D24/111
D430,286 S *	8/2000	Valerio et al.	D24/108
D434,150 S *	11/2000	Tumey et al.	D24/169
D534,654 S *	1/2007	Hayamizu	D24/138
2002/0087179 A1 *	7/2002	Culp et al.	606/167
2008/0015565 A1 *	1/2008	Davison	606/37

* cited by examiner

Primary Examiner—Ian Simmons

Assistant Examiner—Carissa C Fitts

(74) *Attorney, Agent, or Firm*—Paul Vincent

(57) **CLAIM**

The ornamental design for a medical pump, as shown.

DESCRIPTION

FIG. 1 is a front view of medical pump in accordance with my new invention;

FIG. 2 is a perspective view thereof;

FIG. 3 is a rear view thereof;

FIG. 4 is a top view thereof;

FIG. 5 is a bottom view thereof;

FIG. 6 is a side view thereof; and,

FIG. 7 is a second side view thereof.

The broken line showing is for illustrative purposes only and forms no part of the claimed design.

1 Claim, 7 Drawing Sheets

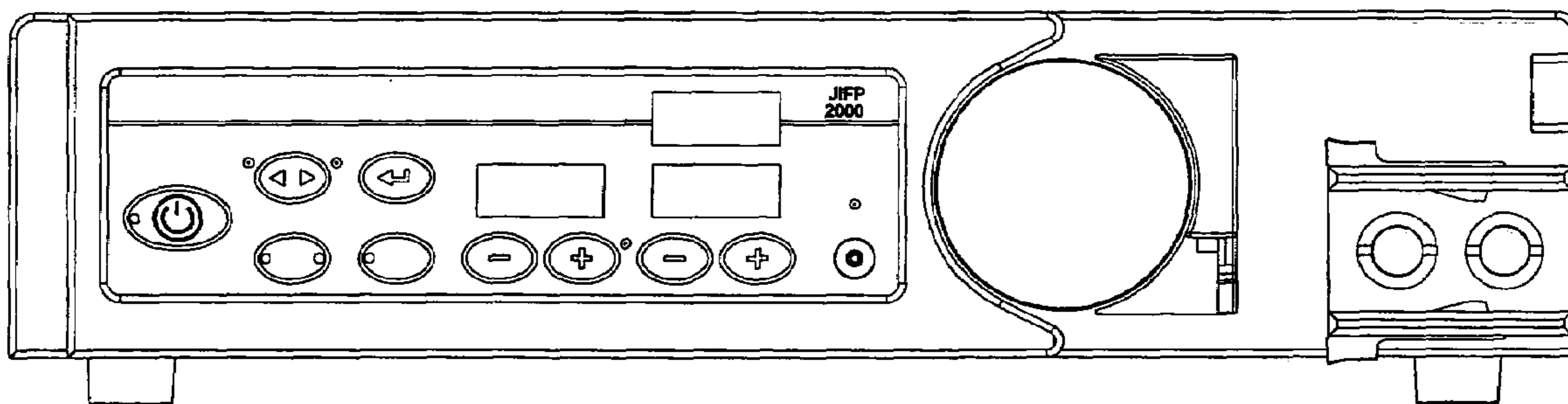

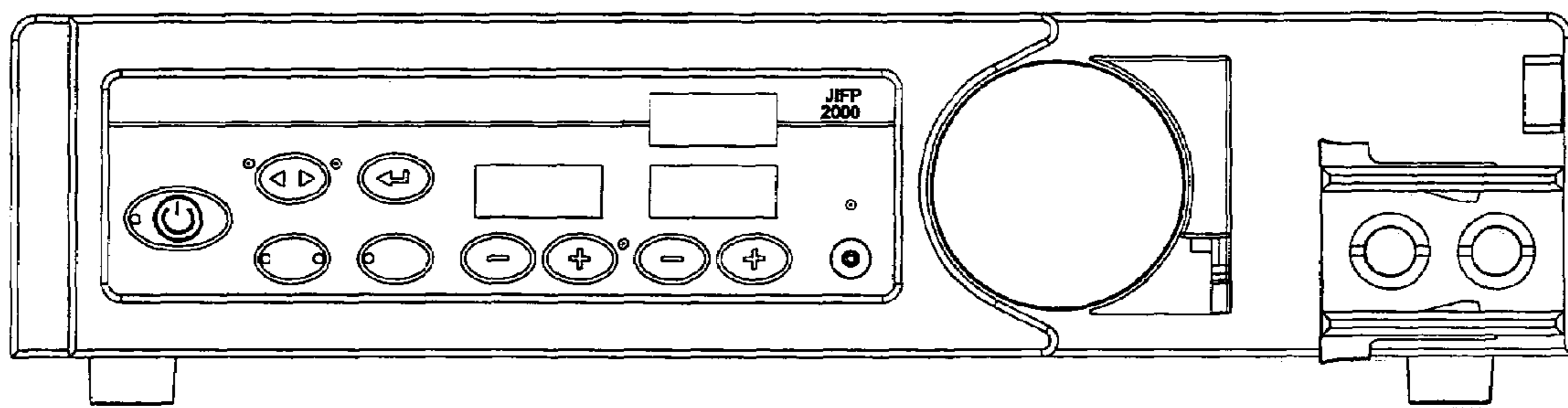

Fig. 1

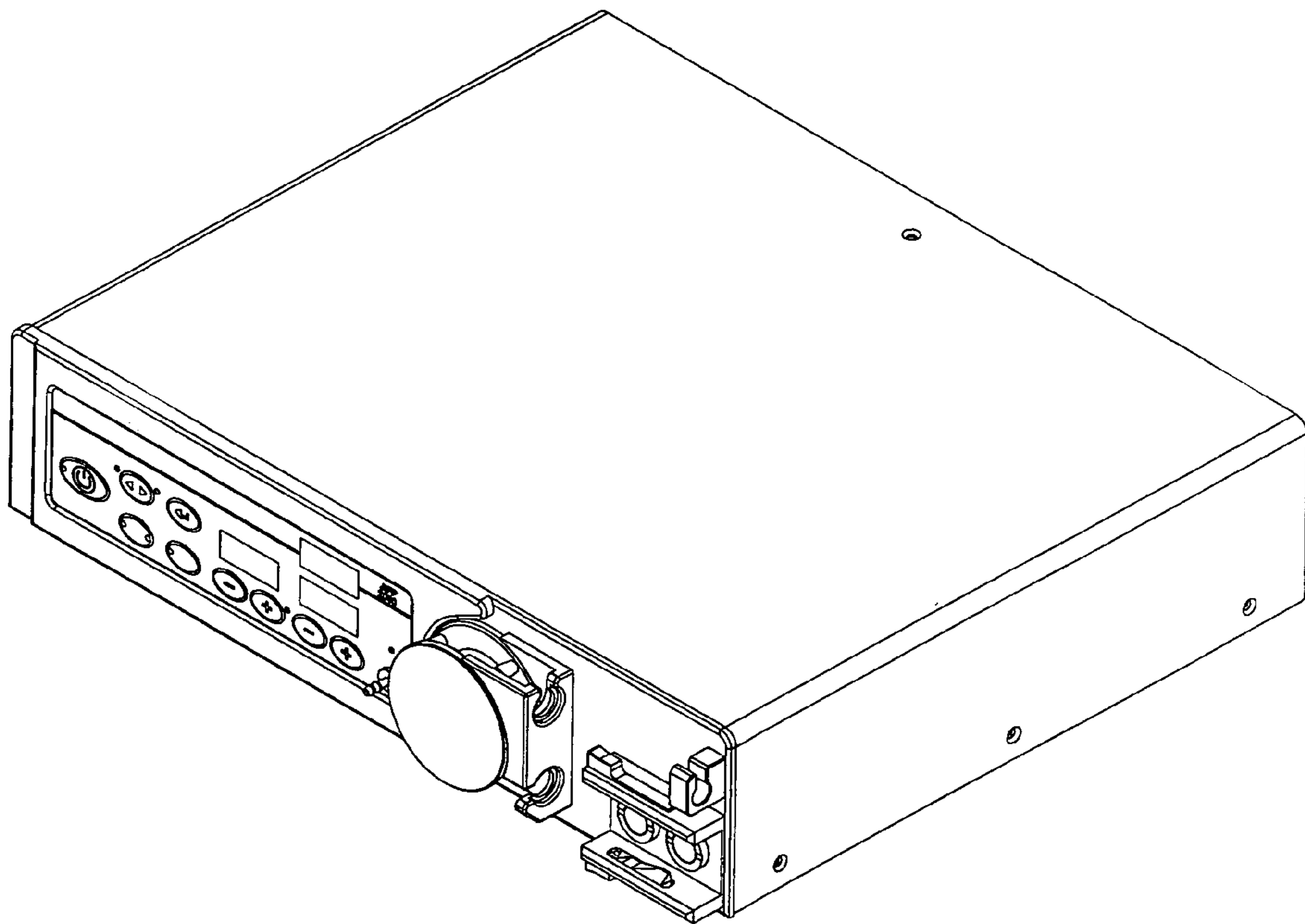

Fig. 2

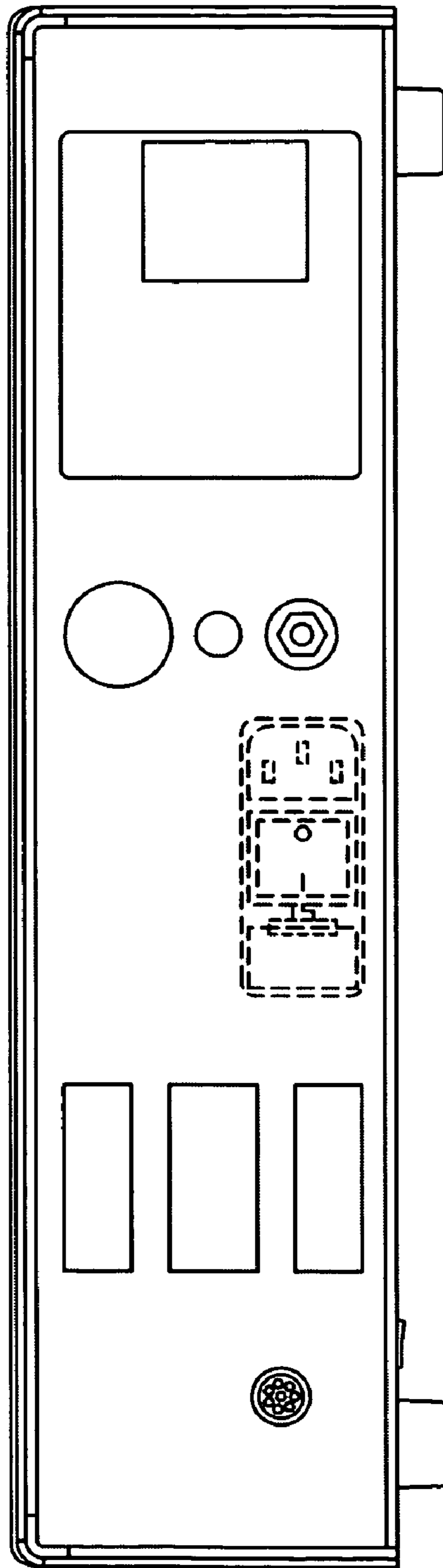

Fig 3

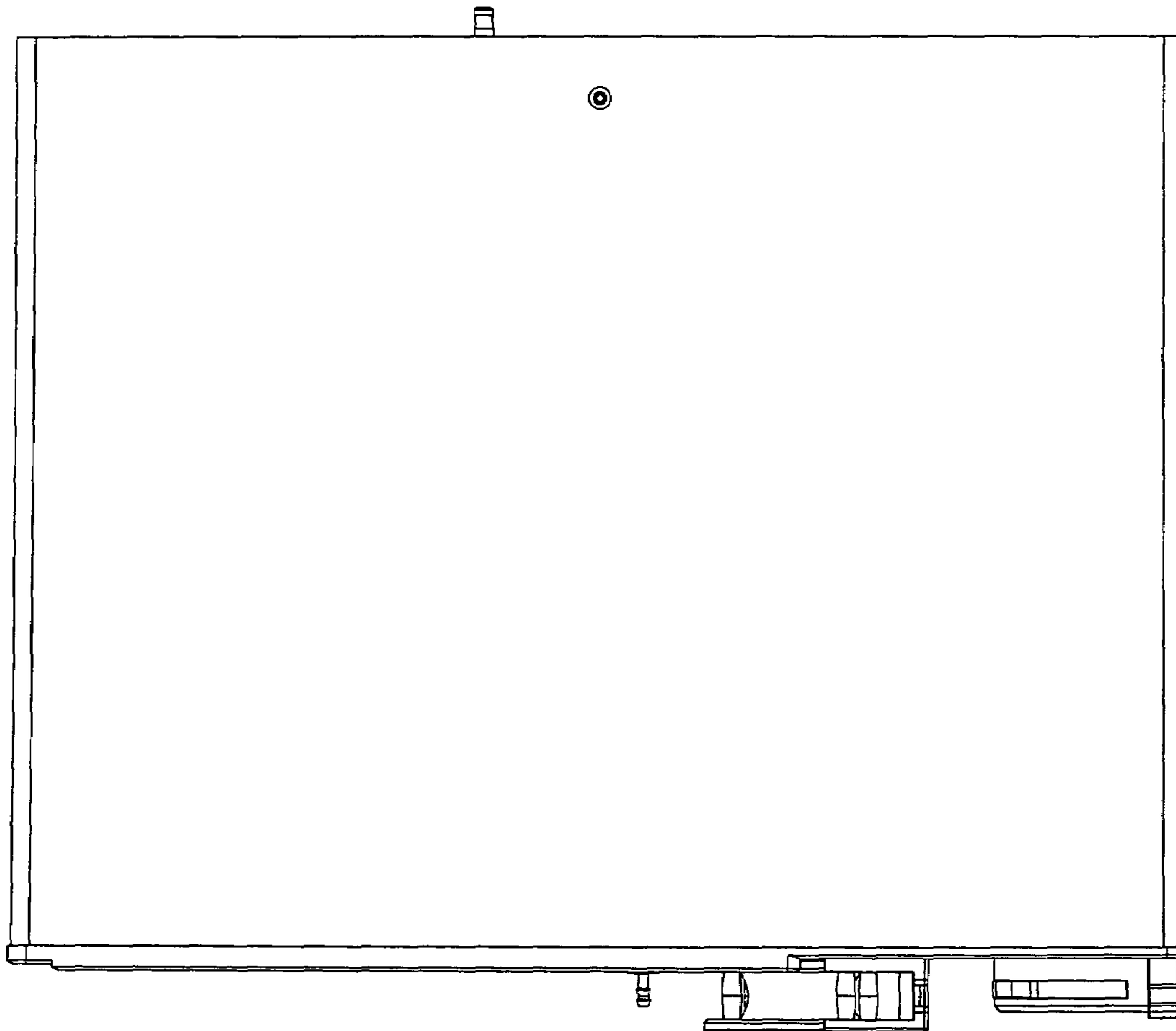

Fig. 4

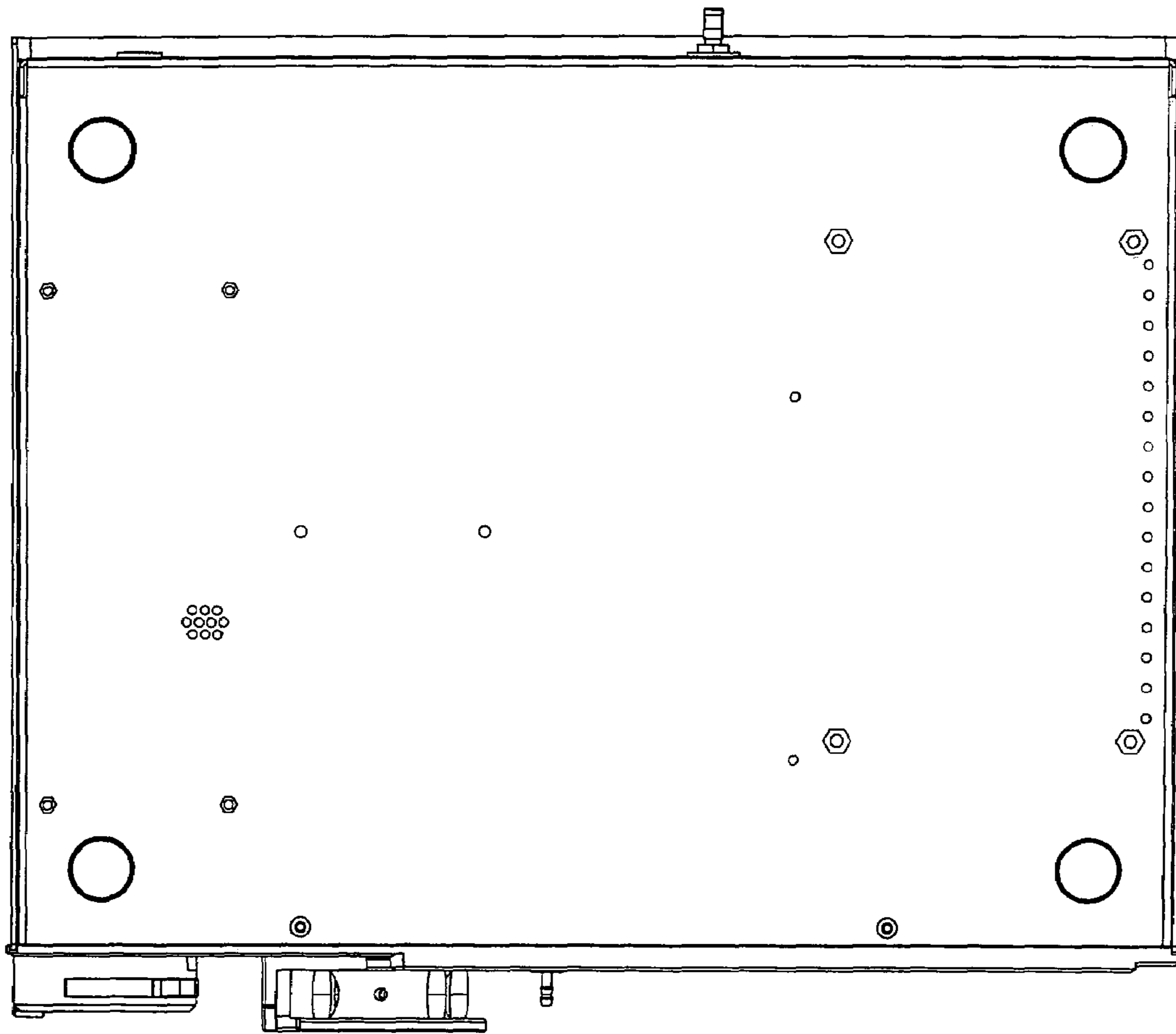

Fig. 5

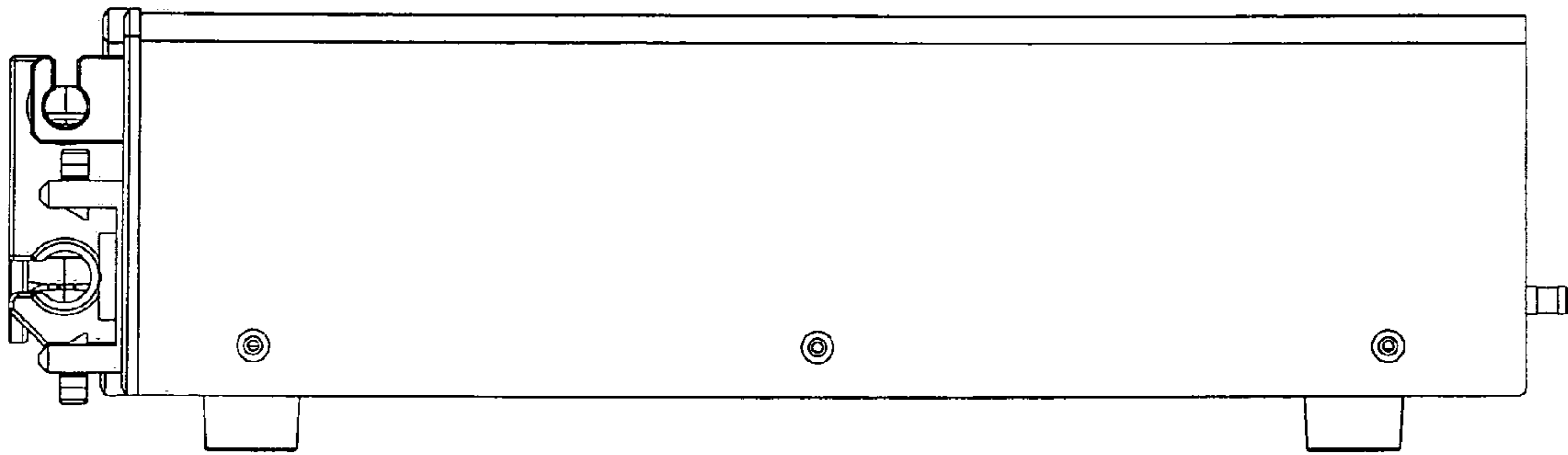

Fig. 6

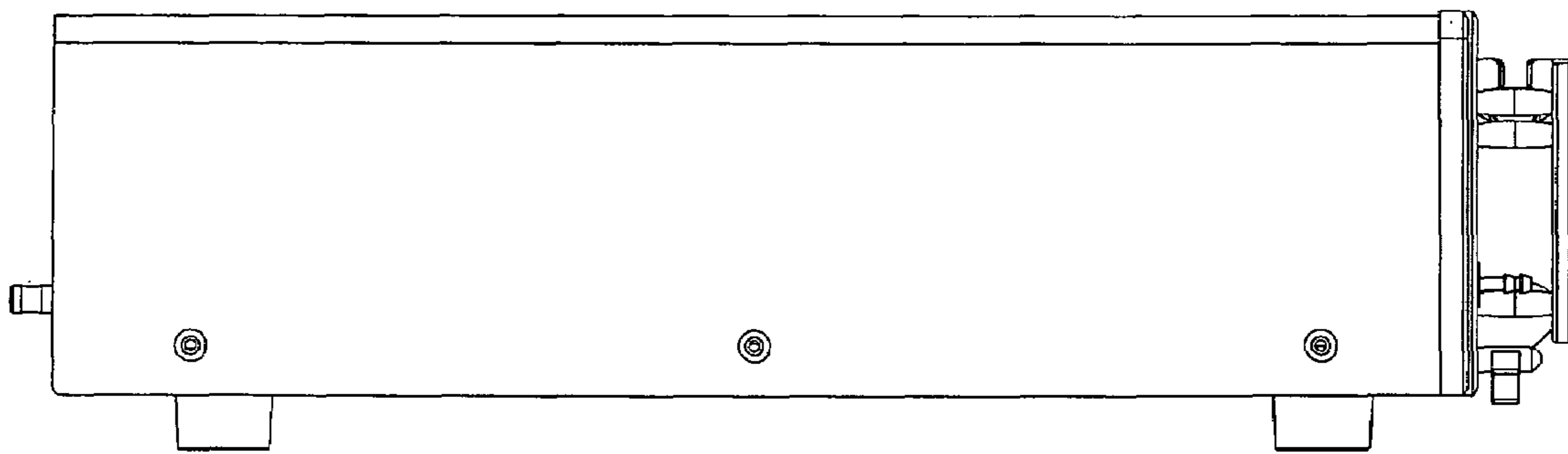

Fig. 7