



US00D584811S

(12) **United States Design Patent**  
**French et al.**

(10) **Patent No.:** **US D584,811 S**

(45) **Date of Patent:** **\*\* Jan. 13, 2009**

(54) **HEATING UNIT**

(75) Inventors: **Ken French**, Meridian, TX (US);  
**Garrett Barker**, Meridian, TX (US);  
**Wyatt Earp**, Los Angeles, CA (US)

(73) Assignee: **ThermaCore Technologies, Inc.**, Dallas, TX (US)

(\*\*) Term: **14 Years**

(21) Appl. No.: **29/252,455**

(22) Filed: **Jan. 24, 2006**

(51) **LOC (9) Cl.** ..... **24-02**

(52) **U.S. Cl.** ..... **D24/111**

(58) **Field of Classification Search** ..... D24/111,  
D24/169, 108; 604/113, 114, 48; 392/465,  
392/481, 489, 470

See application file for complete search history.

(56) **References Cited**

**U.S. PATENT DOCUMENTS**

D232,085	S	*	7/1974	Benzing	.....	D24/111
4,680,445	A	*	7/1987	Ogawa	.....	392/470
4,735,609	A	*	4/1988	Comeau et al.	.....	604/114
5,250,032	A	*	10/1993	Carter et al.	.....	604/113
D350,822	S	*	9/1994	Lanigan	.....	D24/111
5,875,282	A	*	2/1999	Jordan et al.	.....	392/470
6,175,688	B1	*	1/2001	Cassidy et al.	.....	392/470

6,464,666	B1	*	10/2002	Augustine et al.	.....	604/113
6,539,172	B2	*	3/2003	Akahane	.....	392/470
6,788,885	B2	*	9/2004	Mitsunaga et al.	.....	392/470
7,094,219	B2	*	8/2006	Noice et al.	.....	604/113
2006/0222350	A1	*	10/2006	Cassidy	.....	392/470
2007/0049869	A1	*	3/2007	Park	.....	604/113

\* cited by examiner

*Primary Examiner*—Ian Simmons

*Assistant Examiner*—Carissa C Fitts

(74) *Attorney, Agent, or Firm*—Arent Fox LLP

(57) **CLAIM**

The ornamental design for a heating unit, as shown and described.

**DESCRIPTION**

FIG. 1 is a perspective view of the heating unit embodying my design;

FIG. 2 is an alternate perspective view thereof;

FIG. 3 is a top view thereof;

FIG. 4 is a front view thereof;

FIG. 5 is a back view thereof;

FIG. 6 is a right end view thereof;

FIG. 7 is a left end view thereof; and,

FIG. 8 is a bottom view thereof.

**1 Claim, 8 Drawing Sheets**

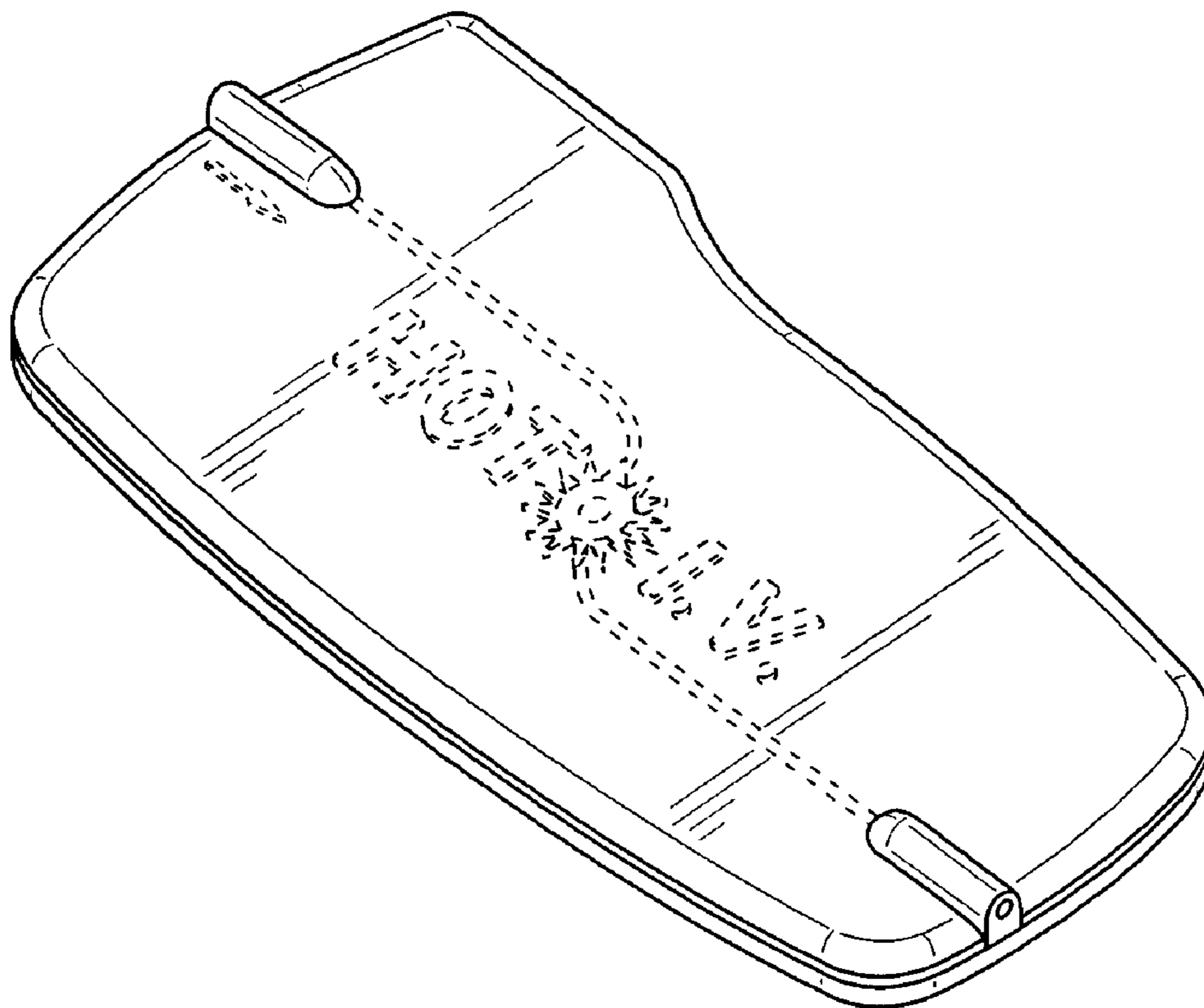

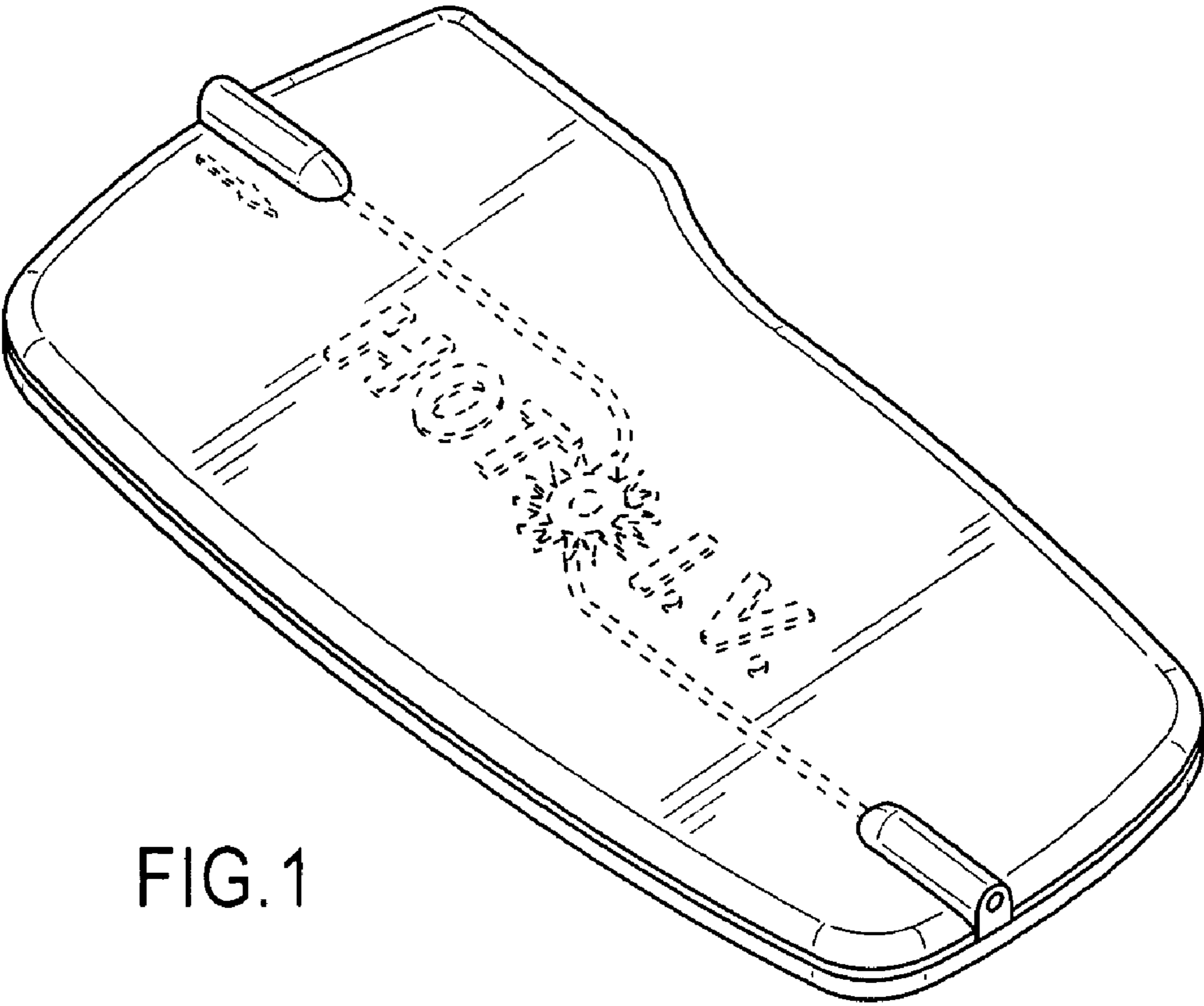

FIG. 1

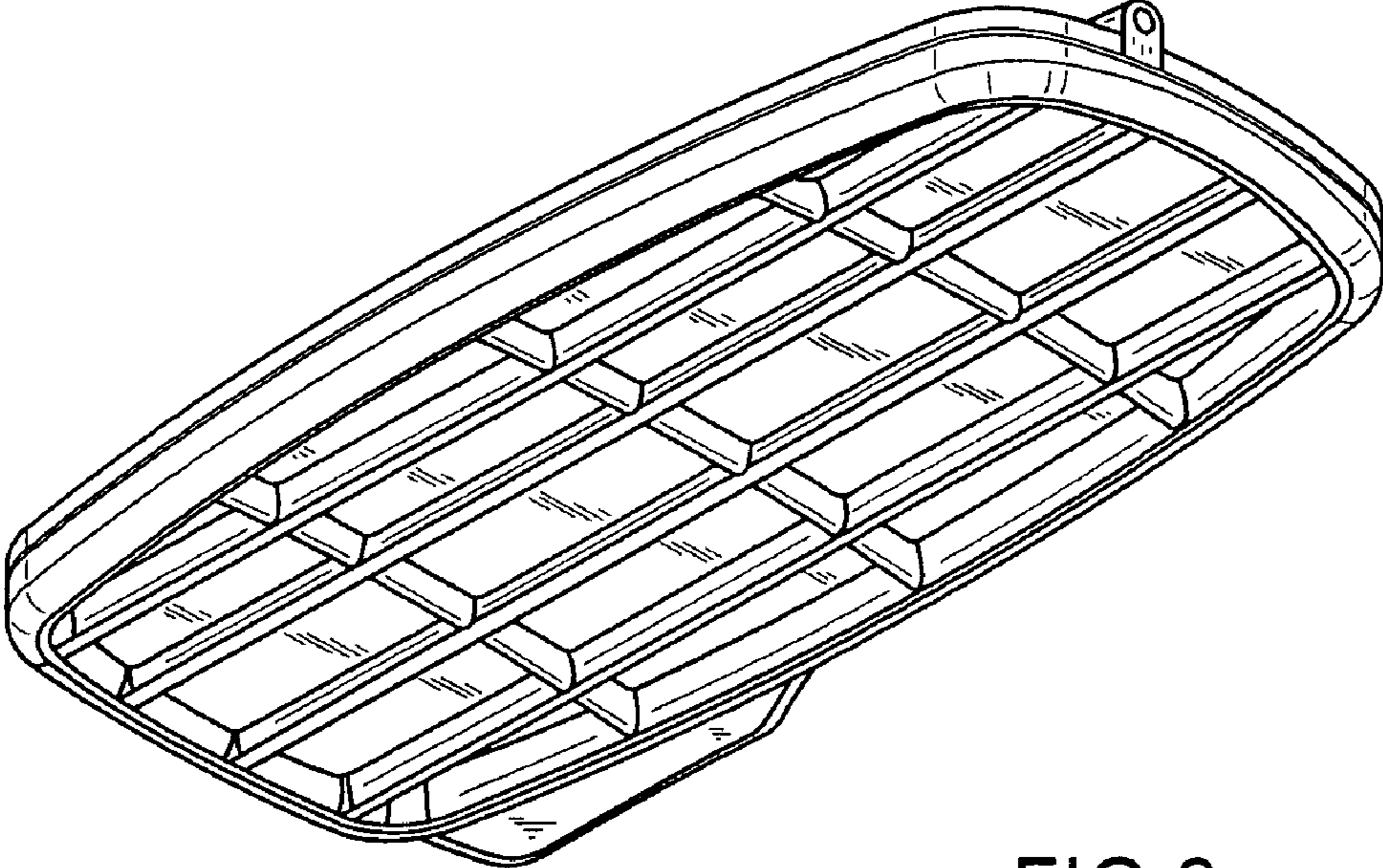

FIG.2

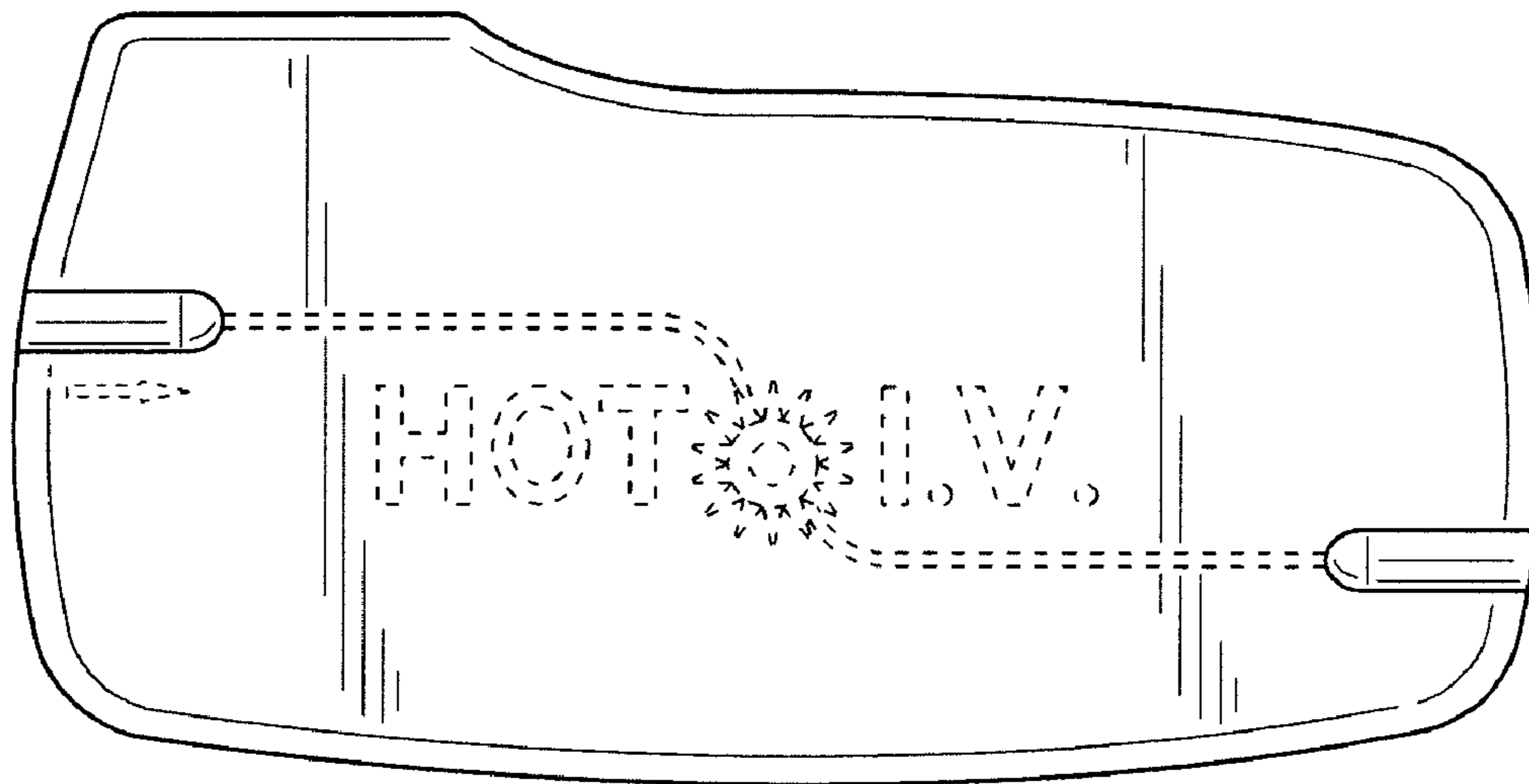

FIG.3



FIG.4

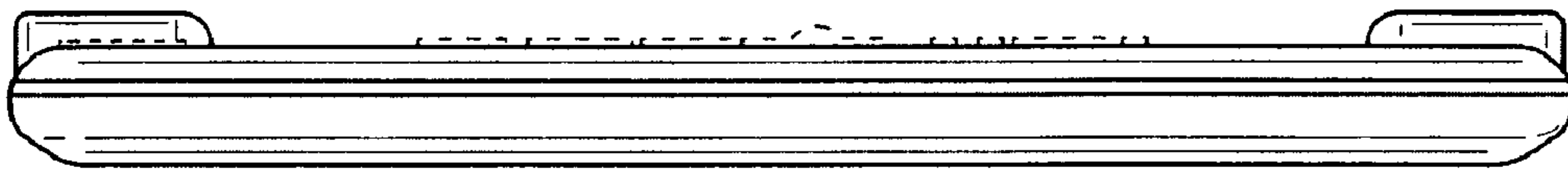

FIG.5

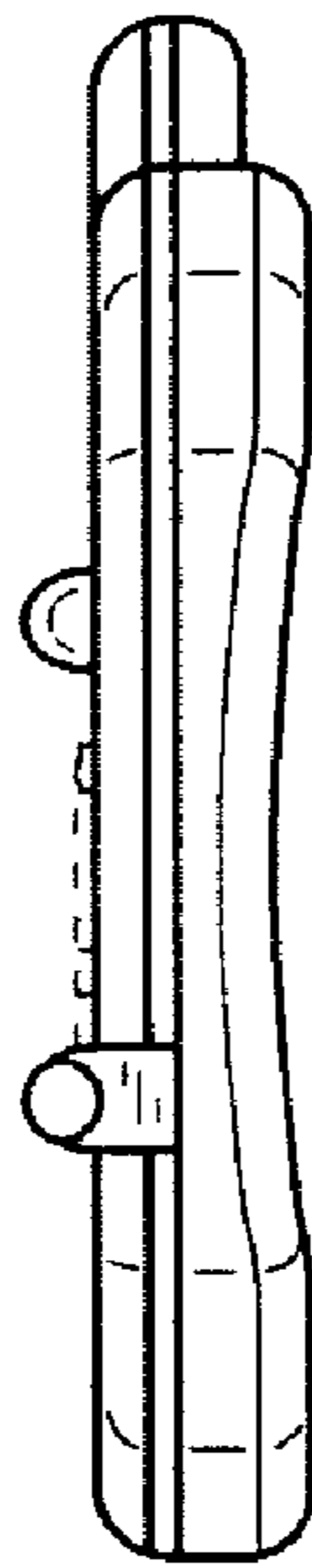

FIG.6

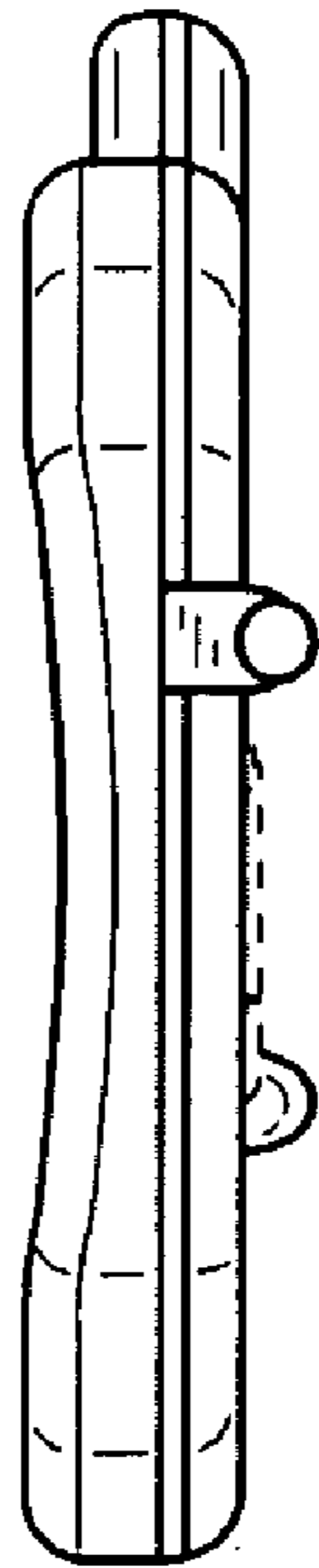

FIG.7



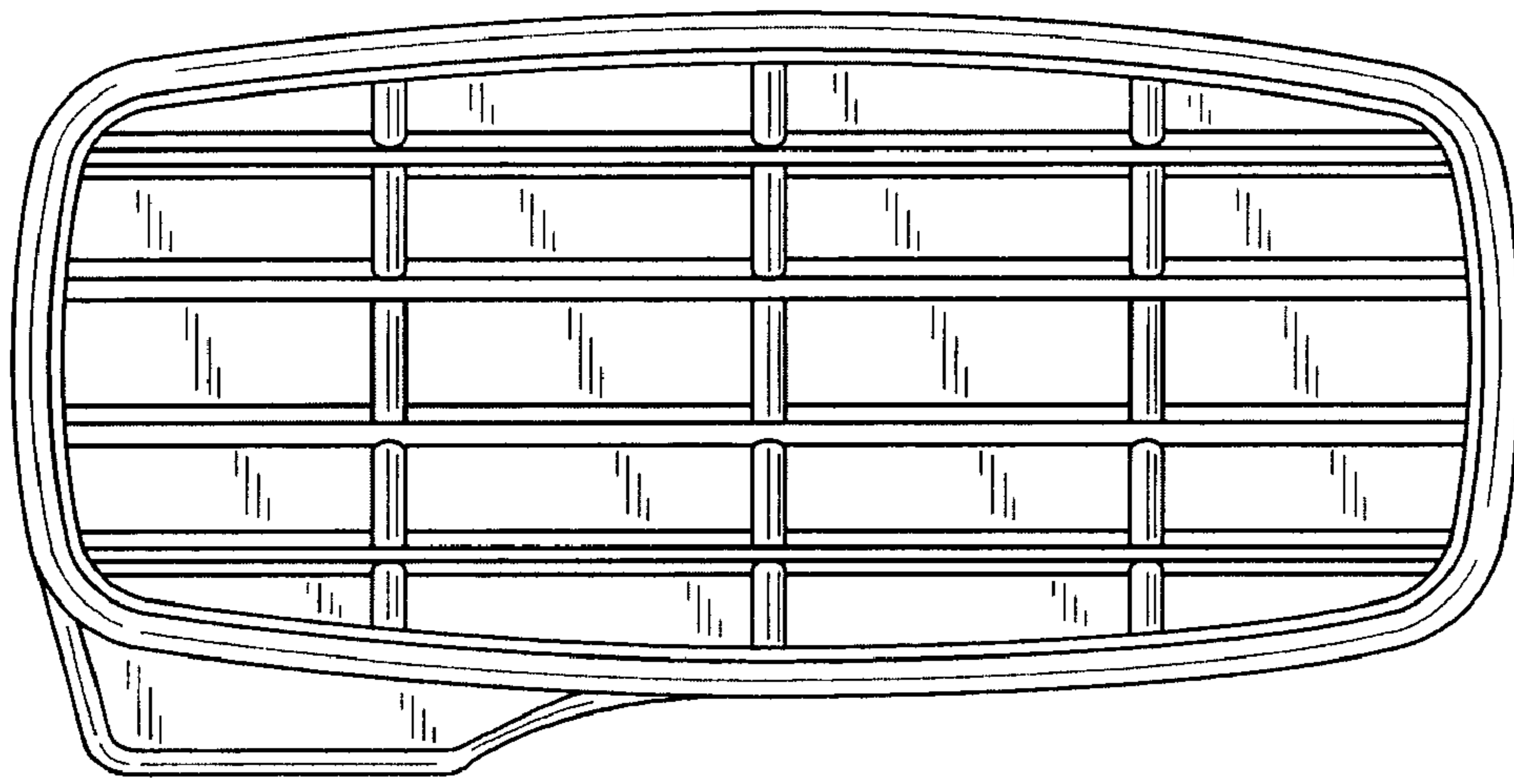

FIG.8