



US00D584715S

(12) **United States Design Patent**
Brennwald

(10) **Patent No.:** **US D584,715 S**
(45) **Date of Patent:** **** Jan. 13, 2009**

(54) **HEADPHONE**

(75) Inventor: **Joerg Brennwald**, Kiel (DE)

(73) Assignee: **Sennheiser electronic GmbH & Co. KG**, Wedemark (DE)

(**) Term: **14 Years**

(21) Appl. No.: **29/282,342**

(22) Filed: **Jul. 17, 2007**

(30) **Foreign Application Priority Data**

Jan. 26, 2007 (DE) 4 07 00 480

(51) **LOC (9) Cl.** **14-01**

(52) **U.S. Cl.** **D14/205**

(58) **Field of Classification Search** D14/205,
D14/206, 223; D29/112; 2/209, 410, 423;
181/129-130; 381/370-371, 374, 376, 377,
381/378, 379; 379/430, 440, 433.01; D21/483;
455/565, 575.2

See application file for complete search history.

(56) **References Cited**

U.S. PATENT DOCUMENTS

3,454,964 A * 7/1969 Brinkhoff 2/209
5,793,878 A * 8/1998 Chang 381/370
D422,592 S * 4/2000 Deguchi D14/205
D435,249 S * 12/2000 Yasutomi D14/205
D457,512 S * 5/2002 Yoneda D14/205
D491,163 S * 6/2004 Green D14/205

D497,608 S * 10/2004 Birgersson D14/205
D514,087 S * 1/2006 Wilson et al. D14/206
D519,497 S * 4/2006 Komiyama D14/223
D532,407 S * 11/2006 Motoishi D14/205
D541,255 S * 4/2007 Taylor et al. D14/205
D549,688 S * 8/2007 Suzuki D14/205
D563,382 S * 3/2008 Wikel D14/205

* cited by examiner

Primary Examiner—Paula Greene

(74) *Attorney, Agent, or Firm*—Reed Smith LLP

(57) **CLAIM**

The ornamental design for headphone, as shown and described.

DESCRIPTION

FIG. 1 illustrates a front view of a headphone in accordance with the invention;

FIG. 2 illustrates a rear view of a headphone in accordance with the invention;

FIG. 3 illustrates a right side view of a headphone in accordance with the invention;

FIG. 4 illustrates a left side view of a headphone in accordance with the invention;

FIG. 5 illustrates a bottom view of a headphone in accordance with the invention; and,

FIG. 6 illustrates a top view of a headphone in accordance with the invention.

1 Claim, 4 Drawing Sheets

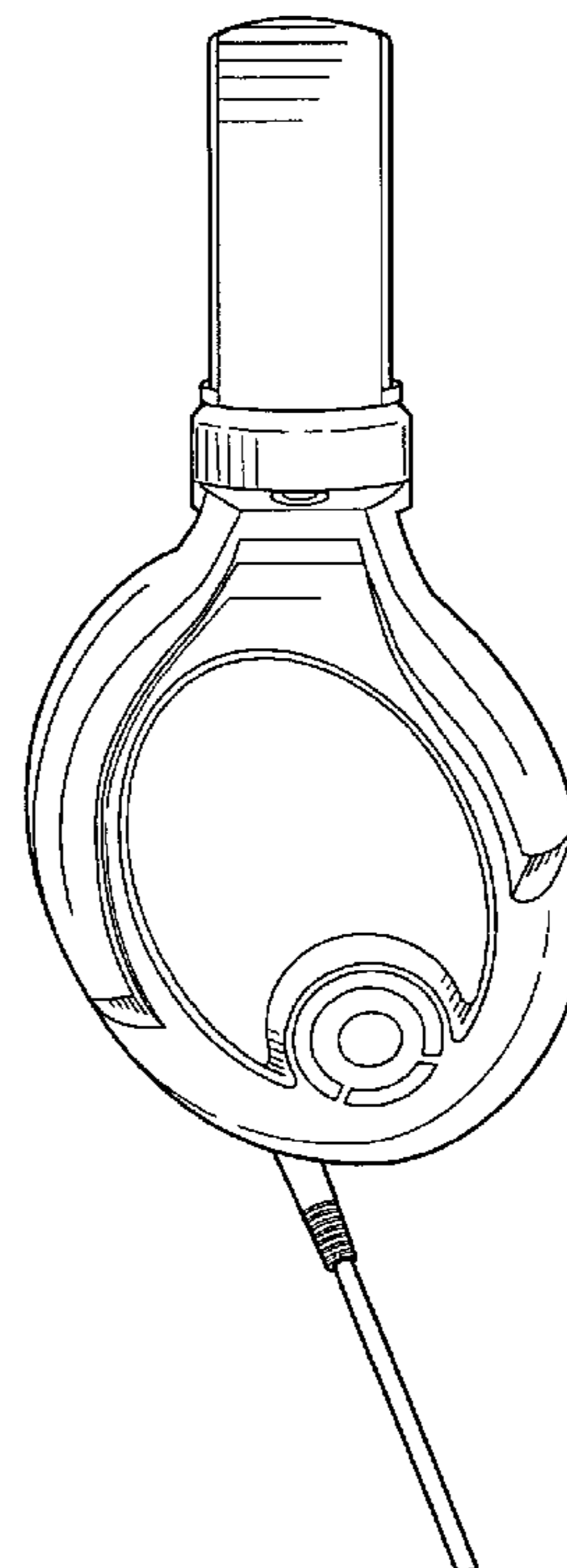
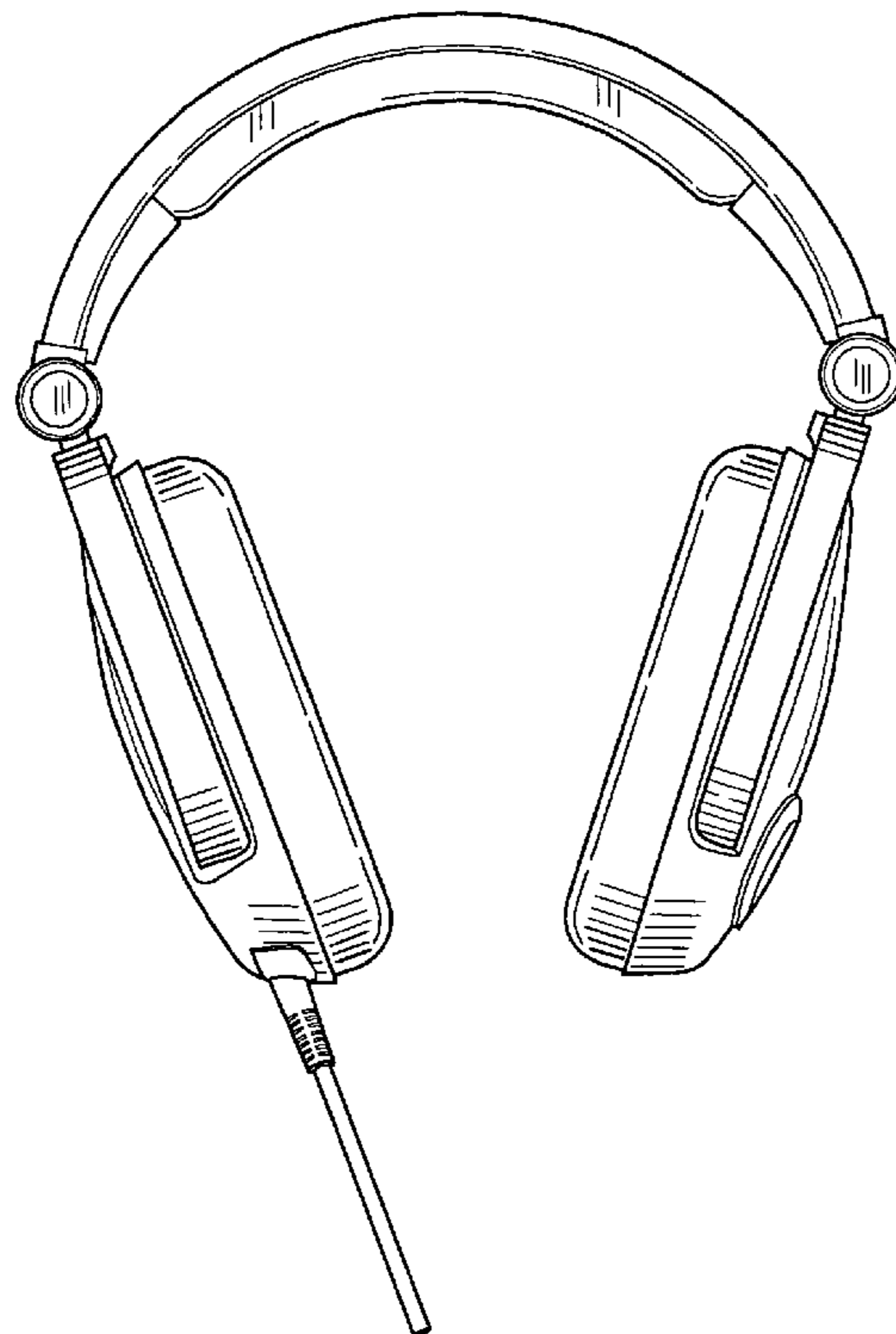

FIG. 1

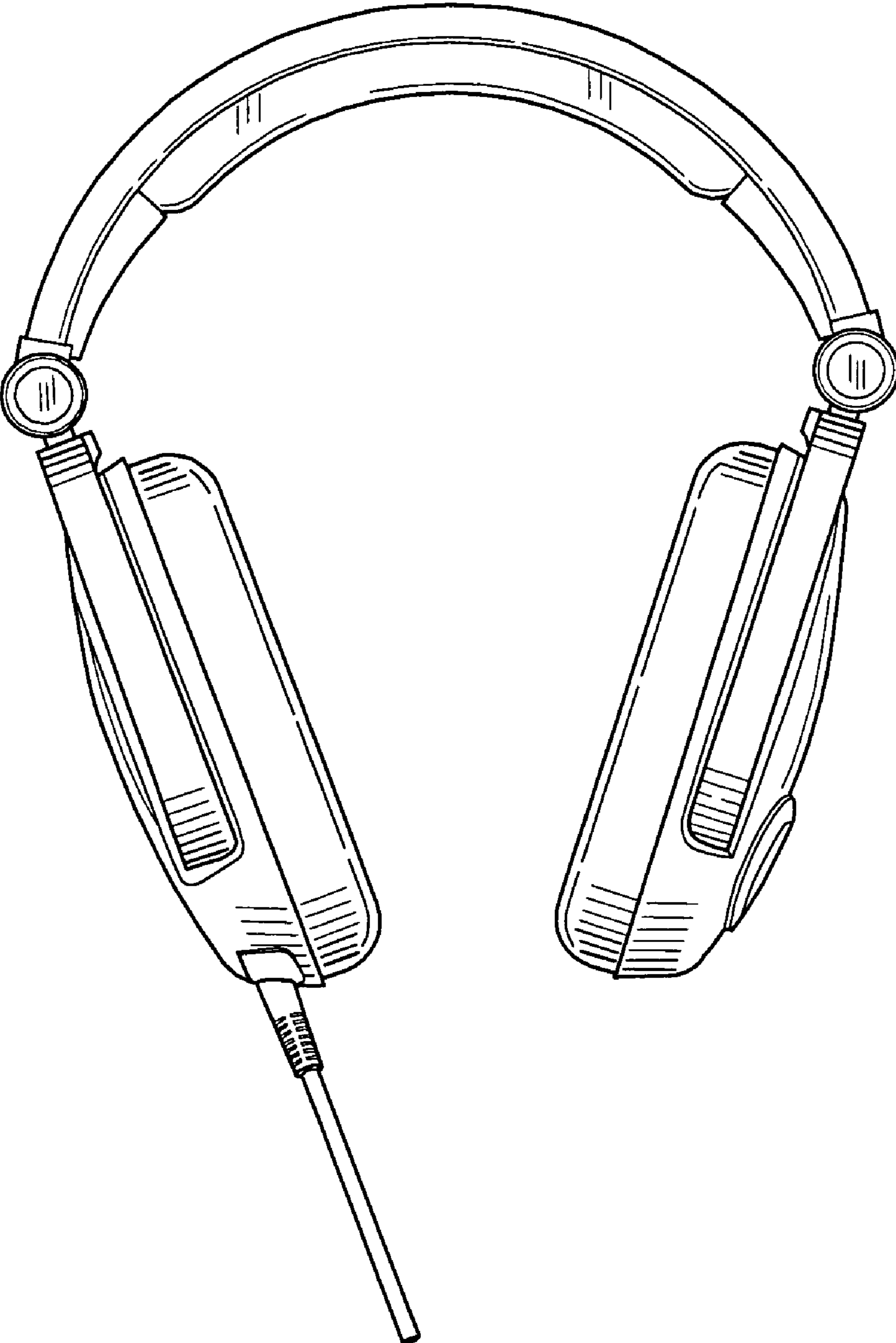

FIG. 2

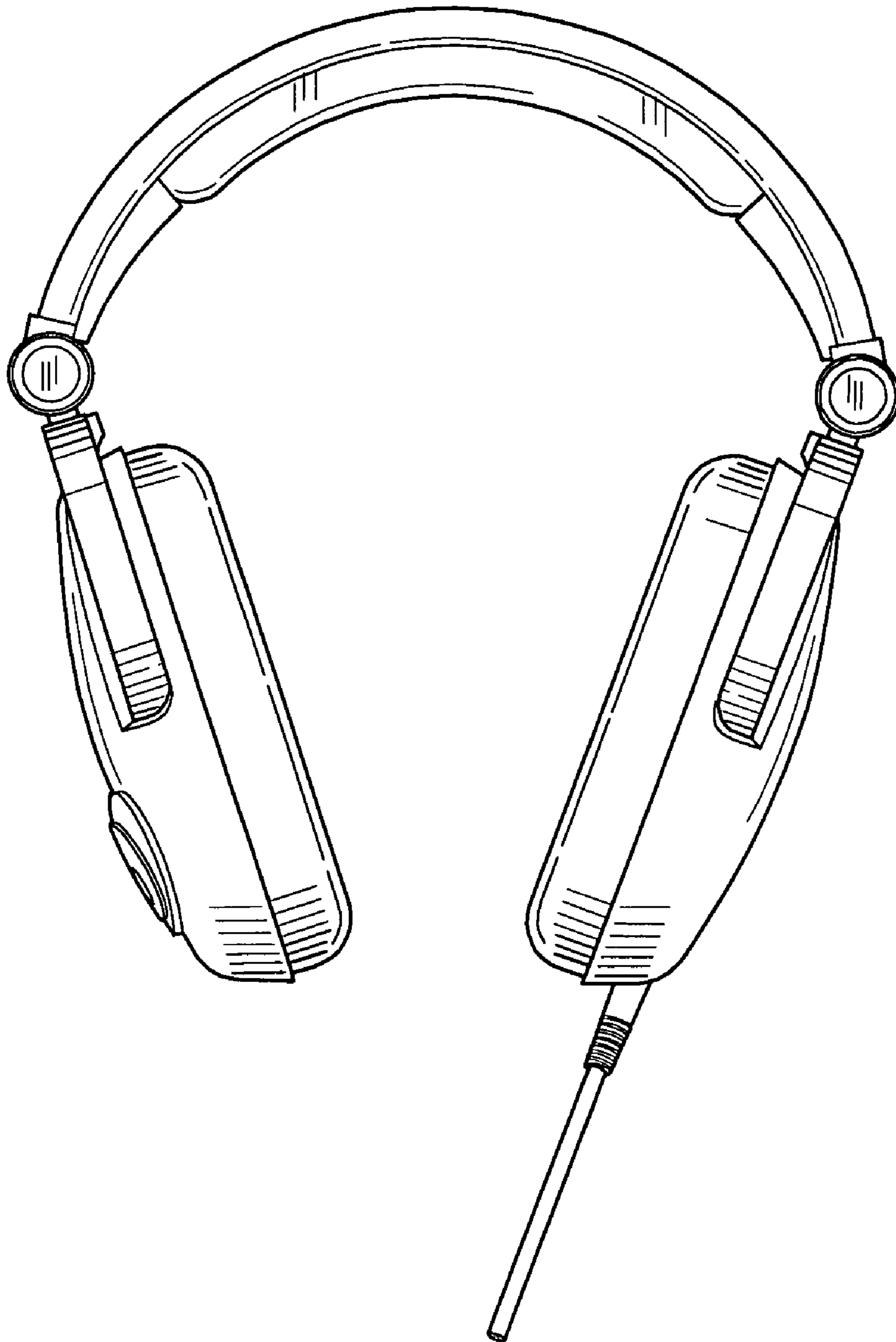

FIG. 3

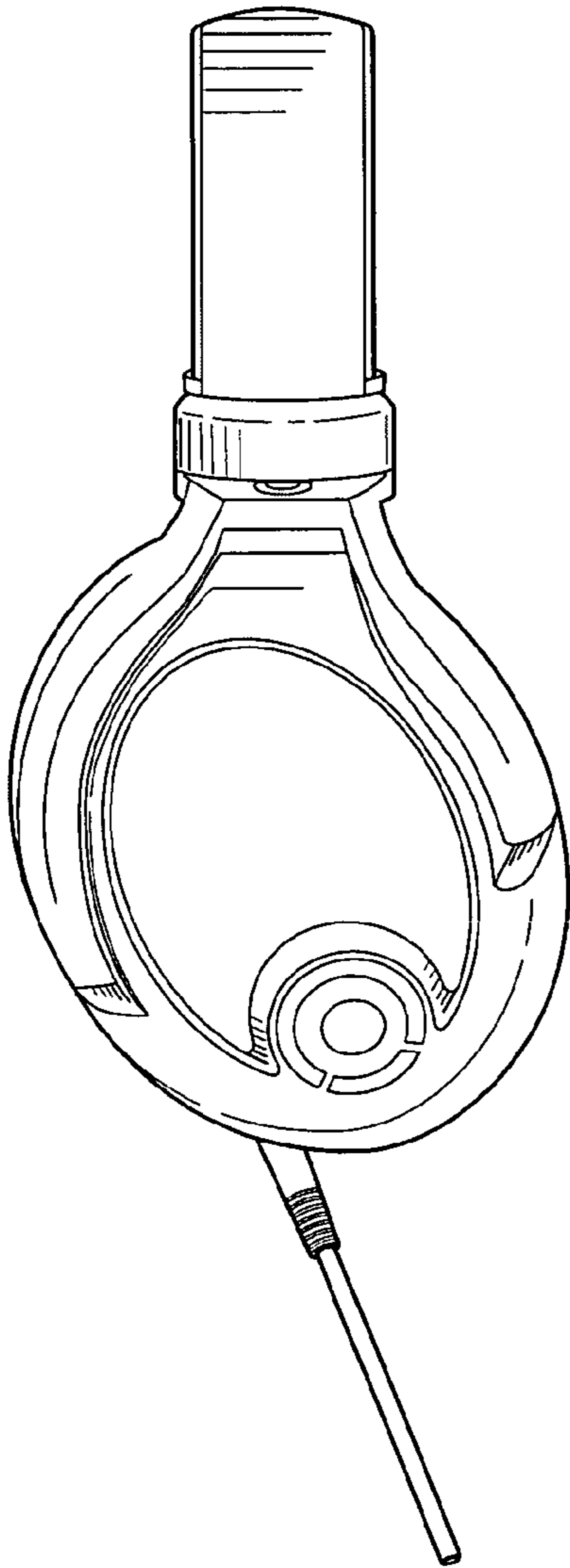

FIG. 4

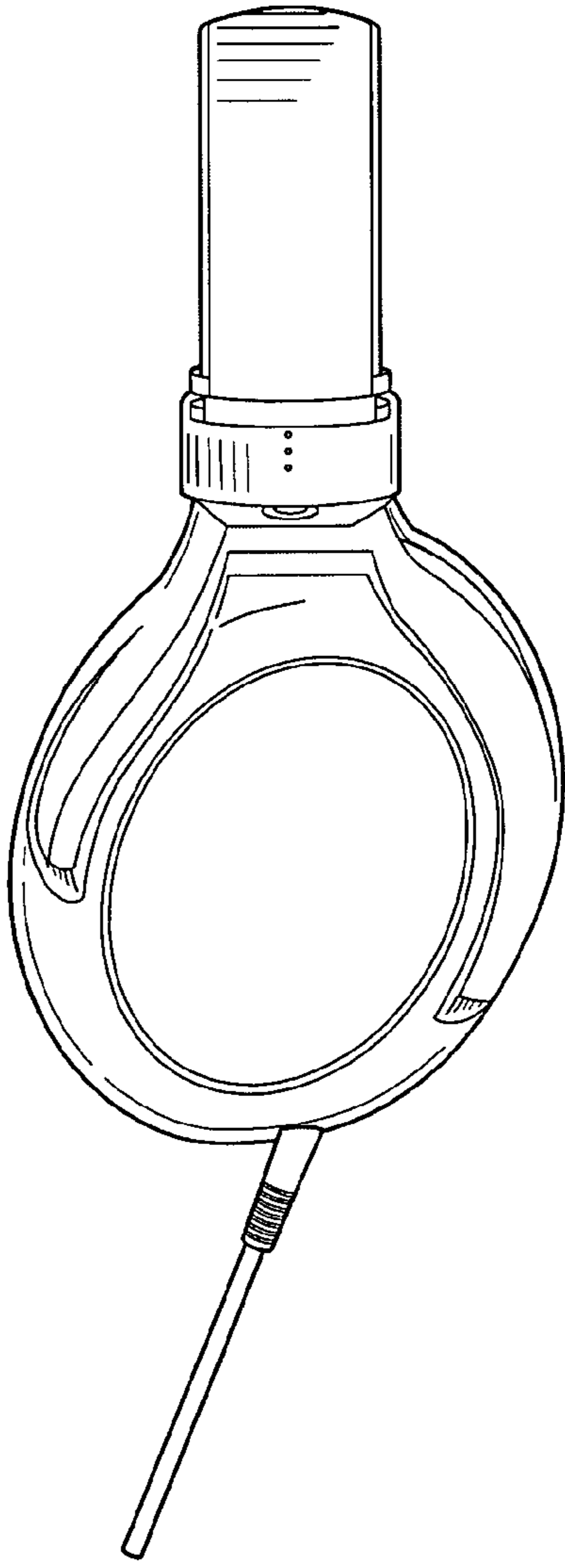

FIG. 5

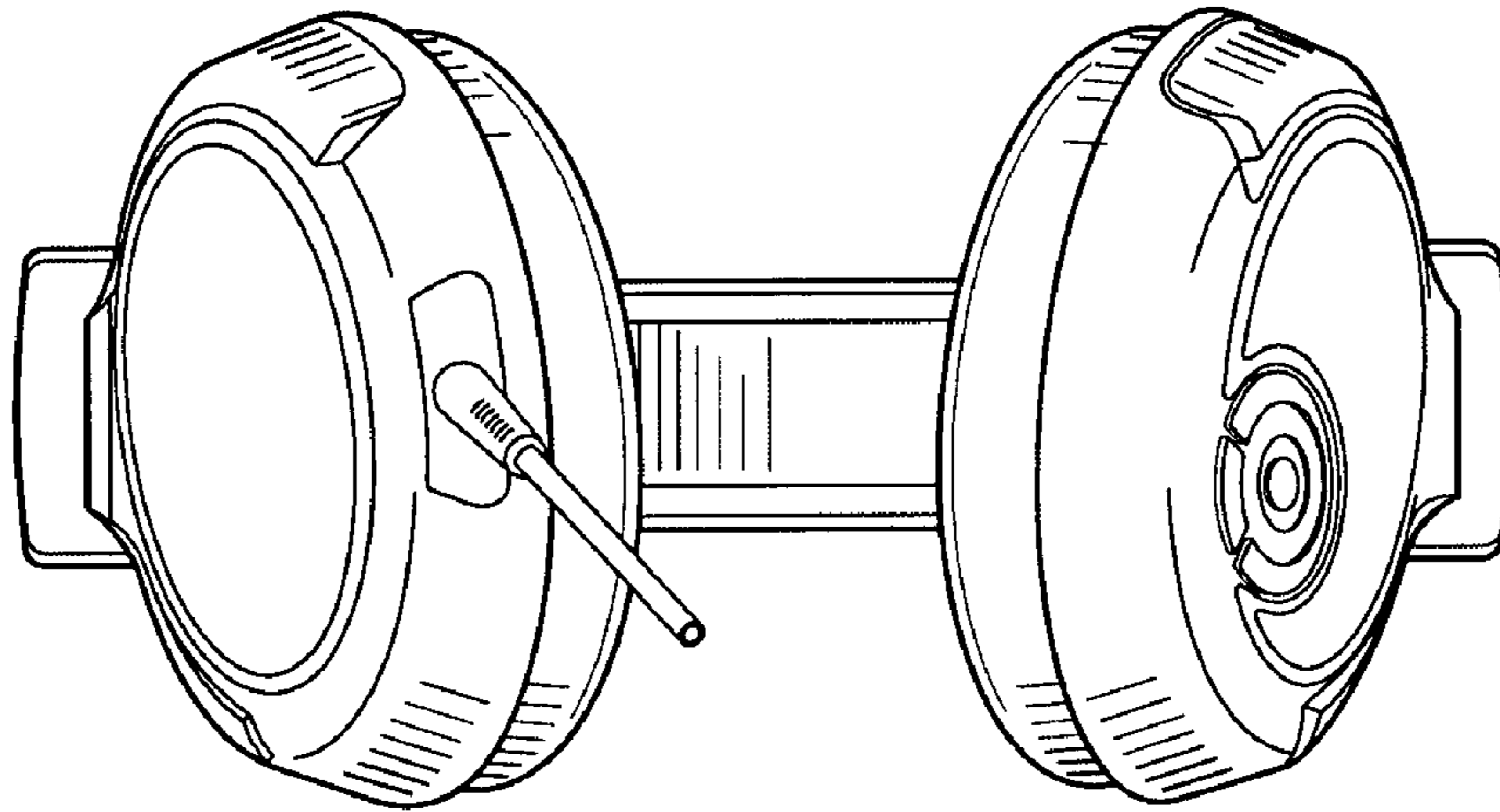

FIG. 6

