



US00D584694S

(12) **United States Design Patent**
Greitzke

(10) **Patent No.:** **US D584,694 S**
(45) **Date of Patent:** **** Jan. 13, 2009**

(54) **REMOTE CONTROL**

(75) Inventor: **Stephan Greitzke**, Iserlohn (DE)

(73) Assignee: **Wilo SE**, Dortmund (DE)

(**) Term: **14 Years**

(21) Appl. No.: **29/291,530**

(22) Filed: **Sep. 4, 2007**

(30) **Foreign Application Priority Data**

Mar. 5, 2007 (EM) 000682174-0005

(51) **LOC (9) Cl.** **13-03**

(52) **U.S. Cl.** **D13/168**

(58) **Field of Classification Search** D13/168;
D10/104, 106; D14/218, 247; 340/825.22,
340/825.24, 825.25, 825.31, 825.36, 825.69,
340/825.72; 341/20, 22, 23, 34, 176; 345/156,
345/158, 169; 348/734; 455/92, 95, 100,
455/128, 151.1-151.4, 352-355; 463/39;
700/17, 19, 20, 65, 83

See application file for complete search history.

(56) **References Cited**

U.S. PATENT DOCUMENTS

D317,310 S * 6/1991 Schwartz D14/218

D341,837 S * 11/1993 Curbbun D14/218
D370,863 S * 6/1996 Carmi D10/106
D428,350 S * 7/2000 Weingartner D10/104
D437,298 S * 2/2001 Picozza et al. D13/168
D512,383 S * 12/2005 Arz et al. D13/168
D561,116 S * 2/2008 Kato D13/168

* cited by examiner

Primary Examiner—Selina Sikder

(74) *Attorney, Agent, or Firm*—Collard & Roe, P.C.

(57) **CLAIM**

The ornamental design for a remote control, as shown and described.

DESCRIPTION

FIG. 1 shows a top perspective view of my design for a remote control;

FIG. 2 shows a top view thereof;

FIG. 3 shows a bottom view thereof;

FIG. 4 shows a front view thereof;

FIG. 5 shows a rear view thereof;

FIG. 6 shows a side view thereof; and,

FIG. 7 shows an opposite side view thereof.

1 Claim, 5 Drawing Sheets

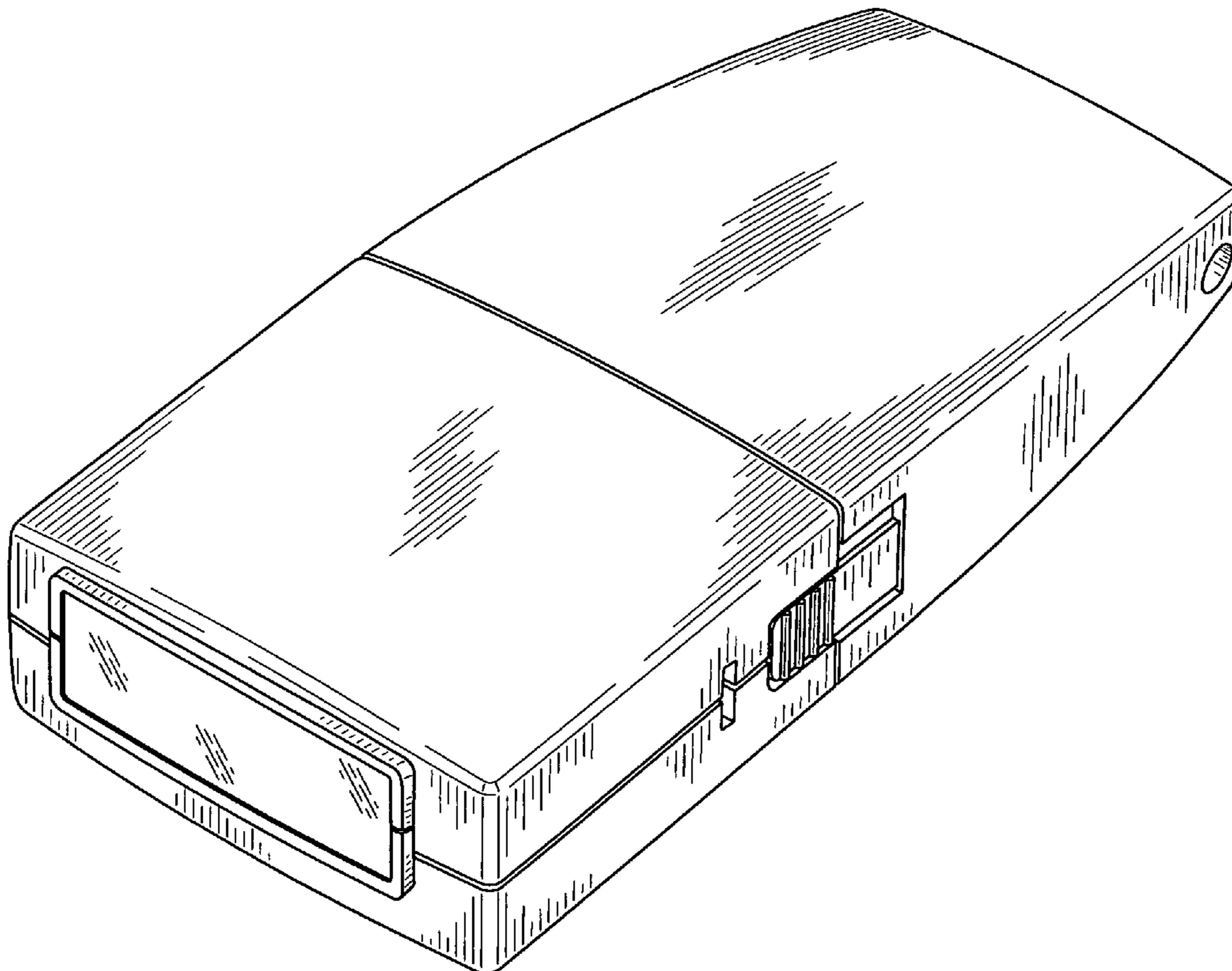

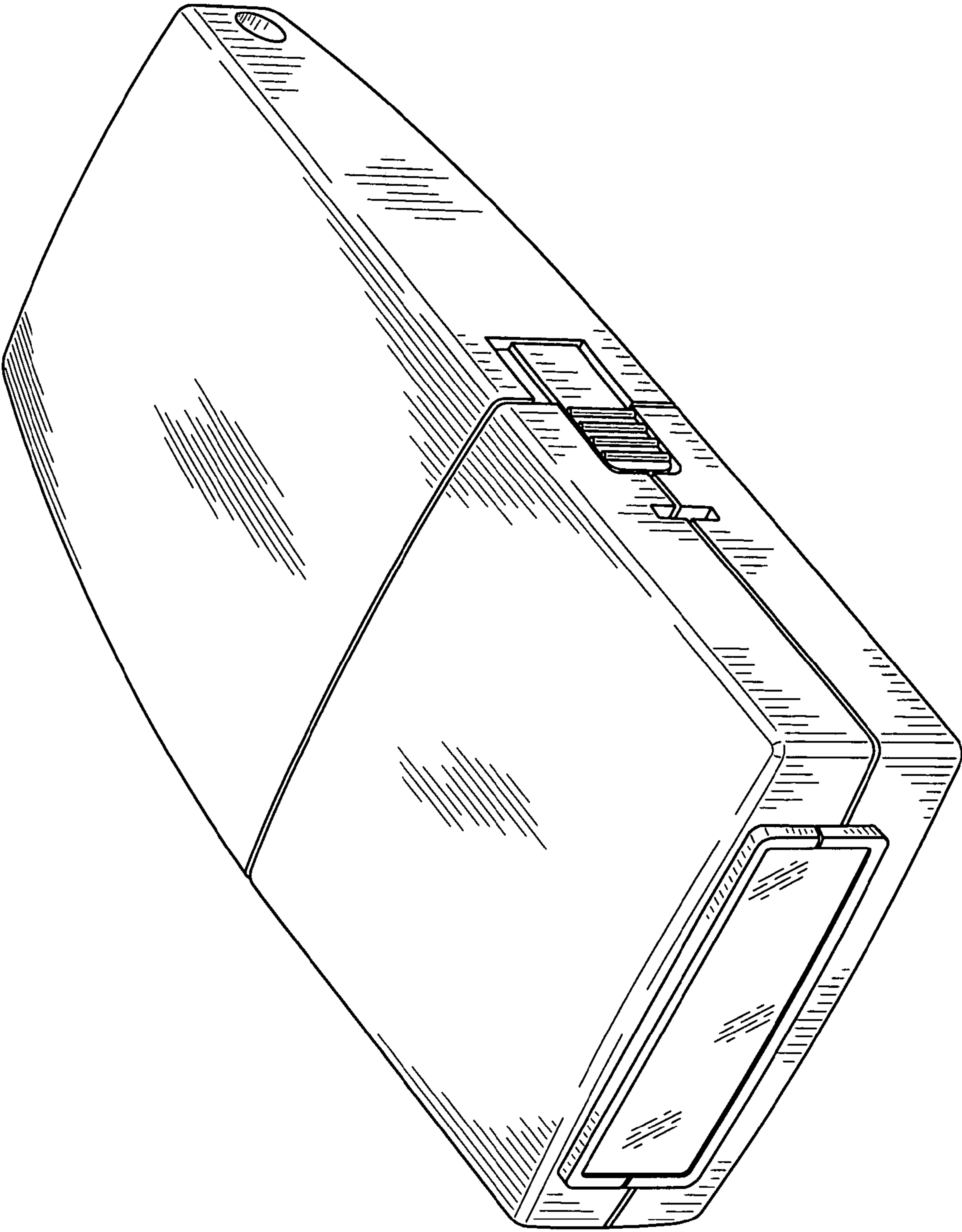

FIG. 1

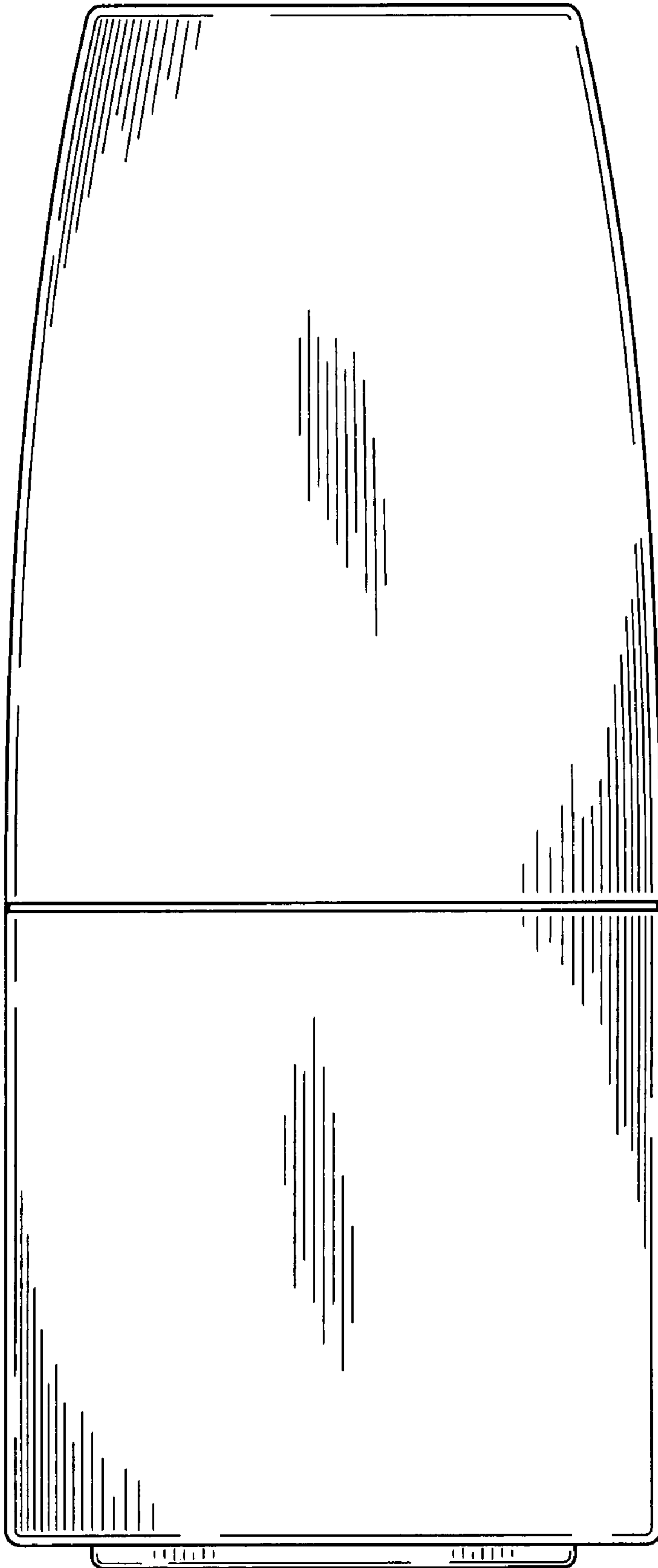

FIG. 2

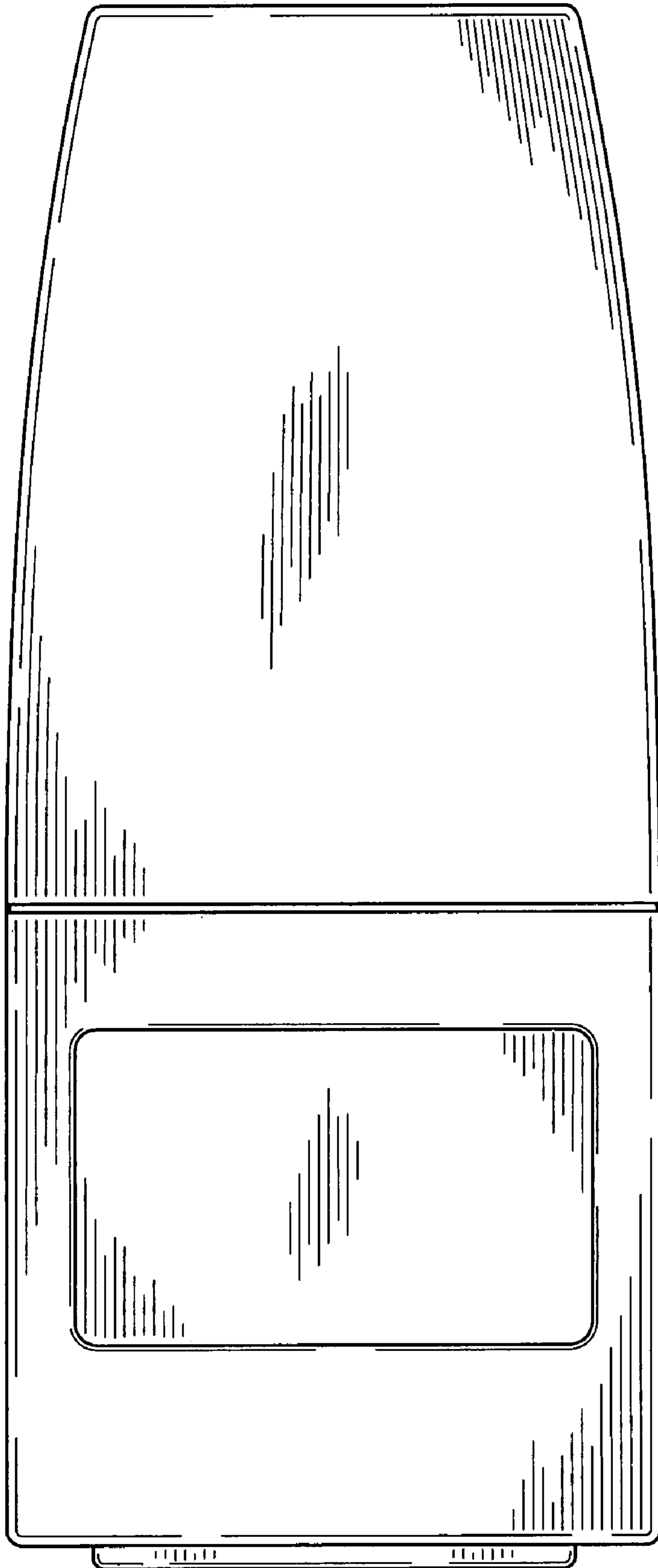

FIG. 3

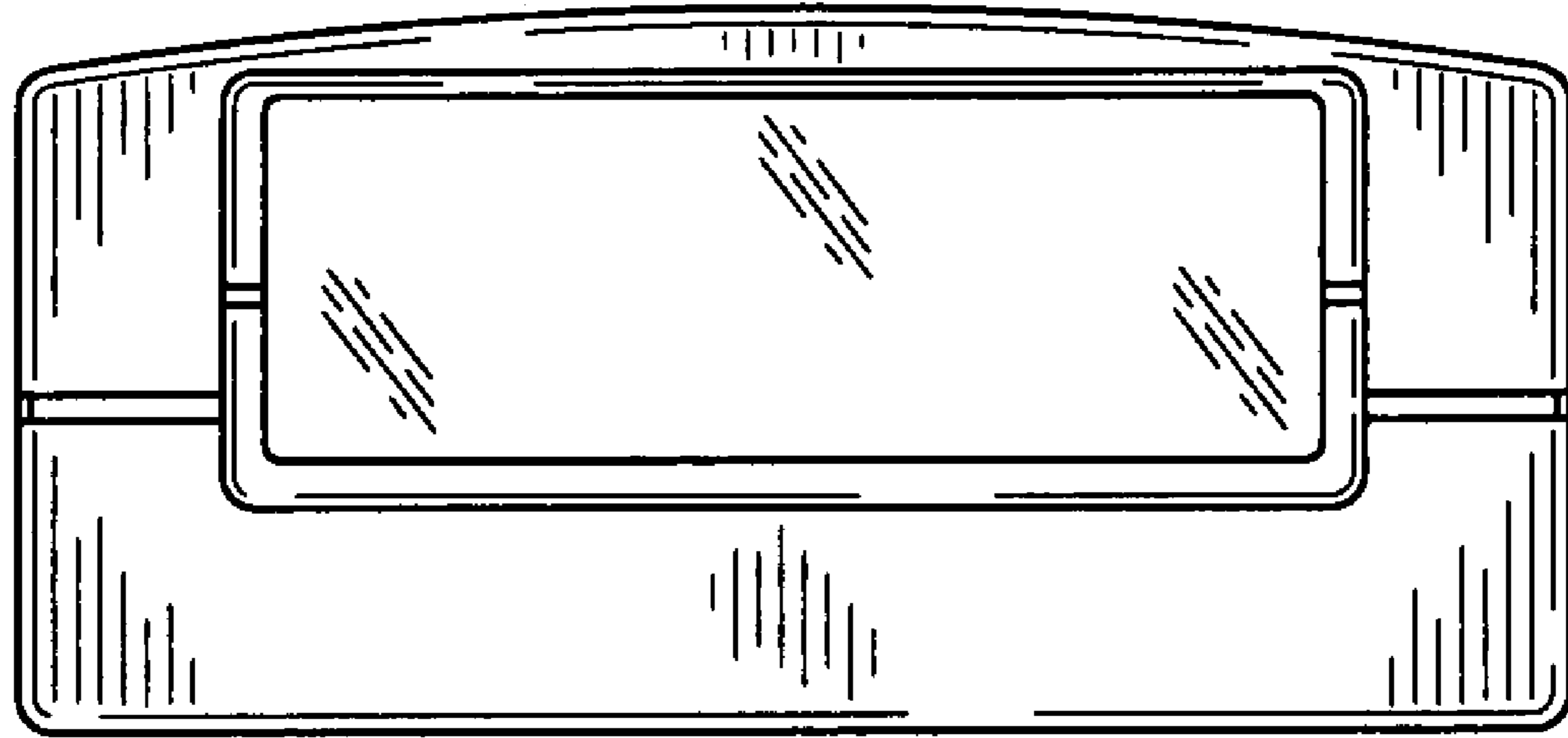

FIG. 4

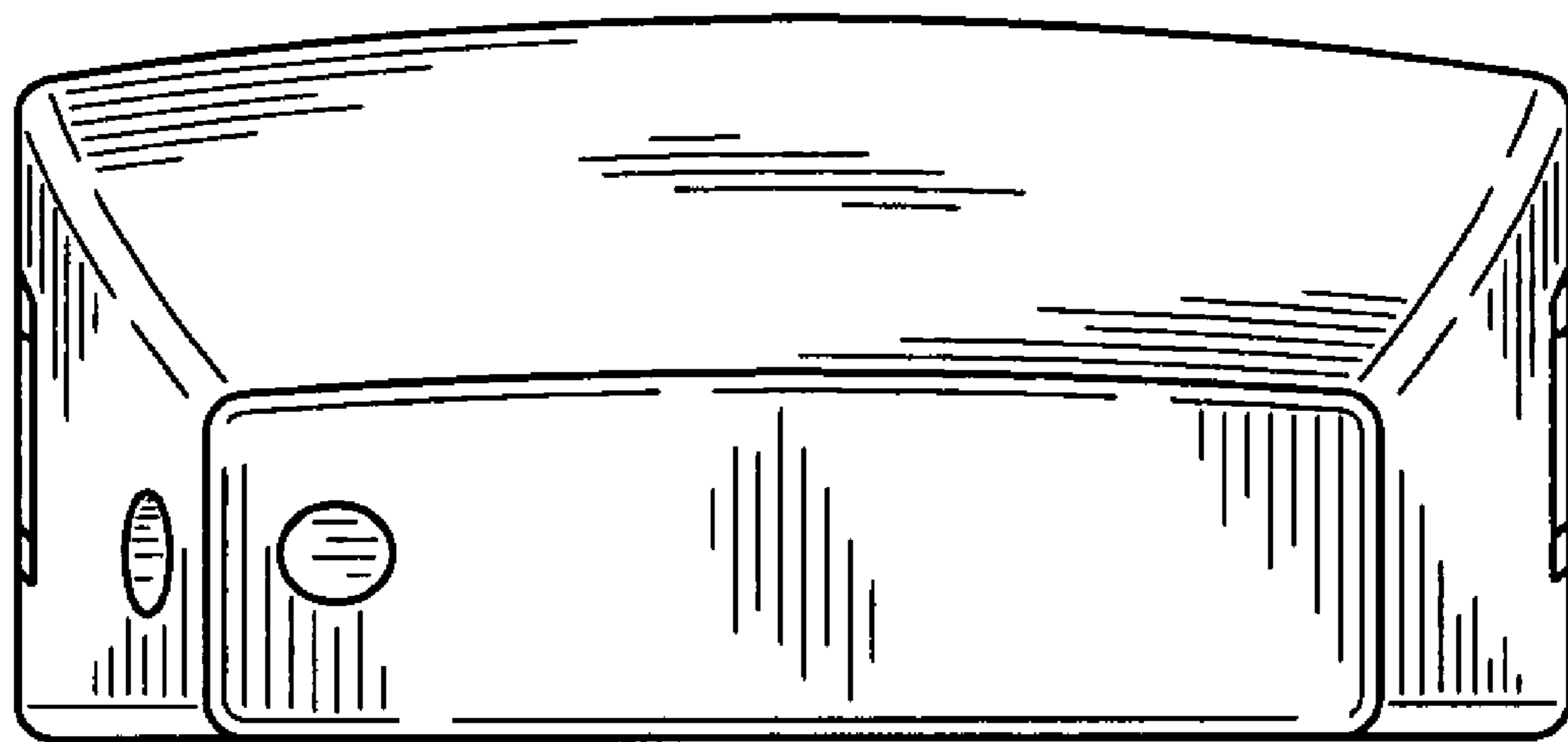

FIG. 5

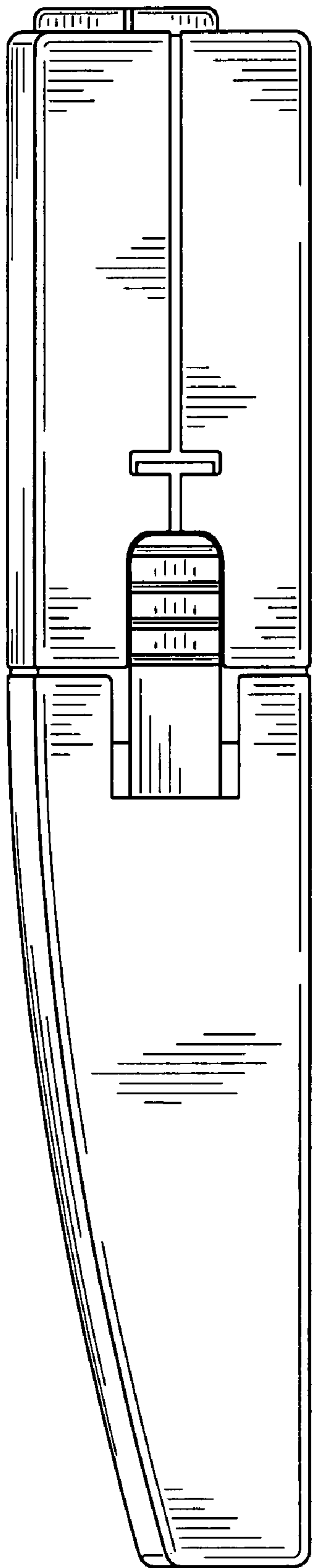

FIG. 6

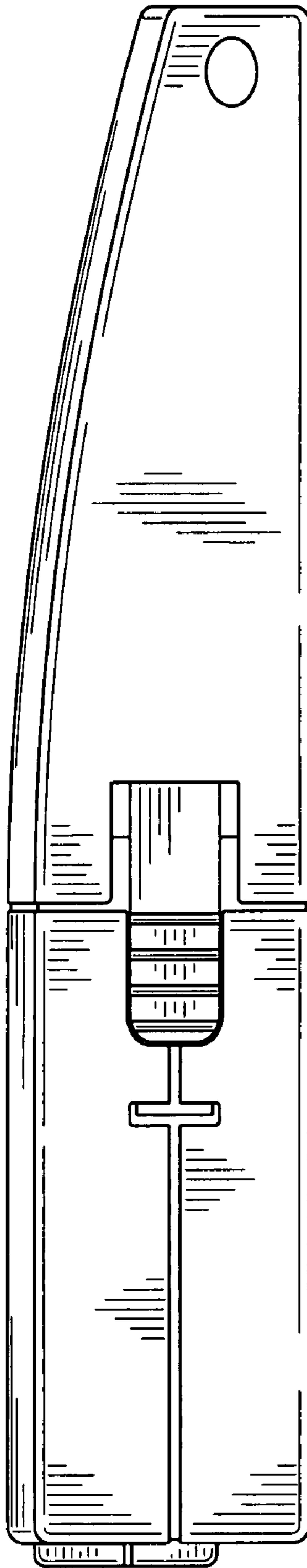

FIG. 7