



US00D584677S

(12) **United States Design Patent**
Jones

(10) **Patent No.:** **US D584,677 S**
(45) **Date of Patent:** **** Jan. 13, 2009**

(54) **FITTED PICKUP TRUCK BED COVERING TARP**

(76) Inventor: **Mack E Jones**, 2797 San Marino Rd., Palm Springs, CA (US) 92262

(**) Term: **14 Years**

(21) Appl. No.: **29/308,889**

(22) Filed: **Jul. 14, 2008**

(51) **LOC (9) Cl.** **12-16**

(52) **U.S. Cl.** **D12/401**

(58) **Field of Classification Search** D12/16,
D12/400-404, 414, 181, 190, 106, 96-100,
D12/196; D25/56; 296/91, 98, 99, 181,
296/183, 90.01, 190.02, 190.08, 190.09,
296/100, 136, 100.1, 39.1, 39.2; 160/26,
160/33, 133; 150/154, 166; 280/770, 847;
180/89.12-89.13, 89.19

See application file for complete search history.

(56) **References Cited**

U.S. PATENT DOCUMENTS

- 5,263,761 A * 11/1993 Hathaway et al. 296/100.18
- D428,382 S * 7/2000 Hall D12/401
- D434,361 S * 11/2000 Block et al. D12/401
- D513,226 S * 12/2005 Sancer D12/401
- 7,086,685 B1 8/2006 Zeugner

* cited by examiner

Primary Examiner—Caron Veynar
Assistant Examiner—Katrina A Kile
(74) *Attorney, Agent, or Firm*—Loyal McKinley Hanson

(57) **CLAIM**

I claim the ornamental design for a fitted pickup truck bed covering tarp, as shown and described.

DESCRIPTION

FIG. 1 of the drawings is a perspective view showing the back, right side, and top of a fitted pickup truck bed covering tarp embodying the design of my invention,

FIG. 2 is an elevation view of the back of the fitted pickup truck bed covering tarp;

FIG. 3 is an elevation view of the right side of the fitted pickup truck bed covering tarp;

FIG. 4 is a plan view of the top of the fitted pickup truck bed covering tarp;

FIG. 5 is an elevation view of the right side of the fitted pickup truck bed covering tarp;

FIG. 6 is an elevation view of the front of the fitted pickup truck bed covering tarp; and,

FIG. 7 is a plan view of the bottom of the fitted pickup truck bed covering tarp.

In the drawings, the broken lines showing a pick up truck and tie down cords form no part of the claimed design.

1 Claim, 5 Drawing Sheets

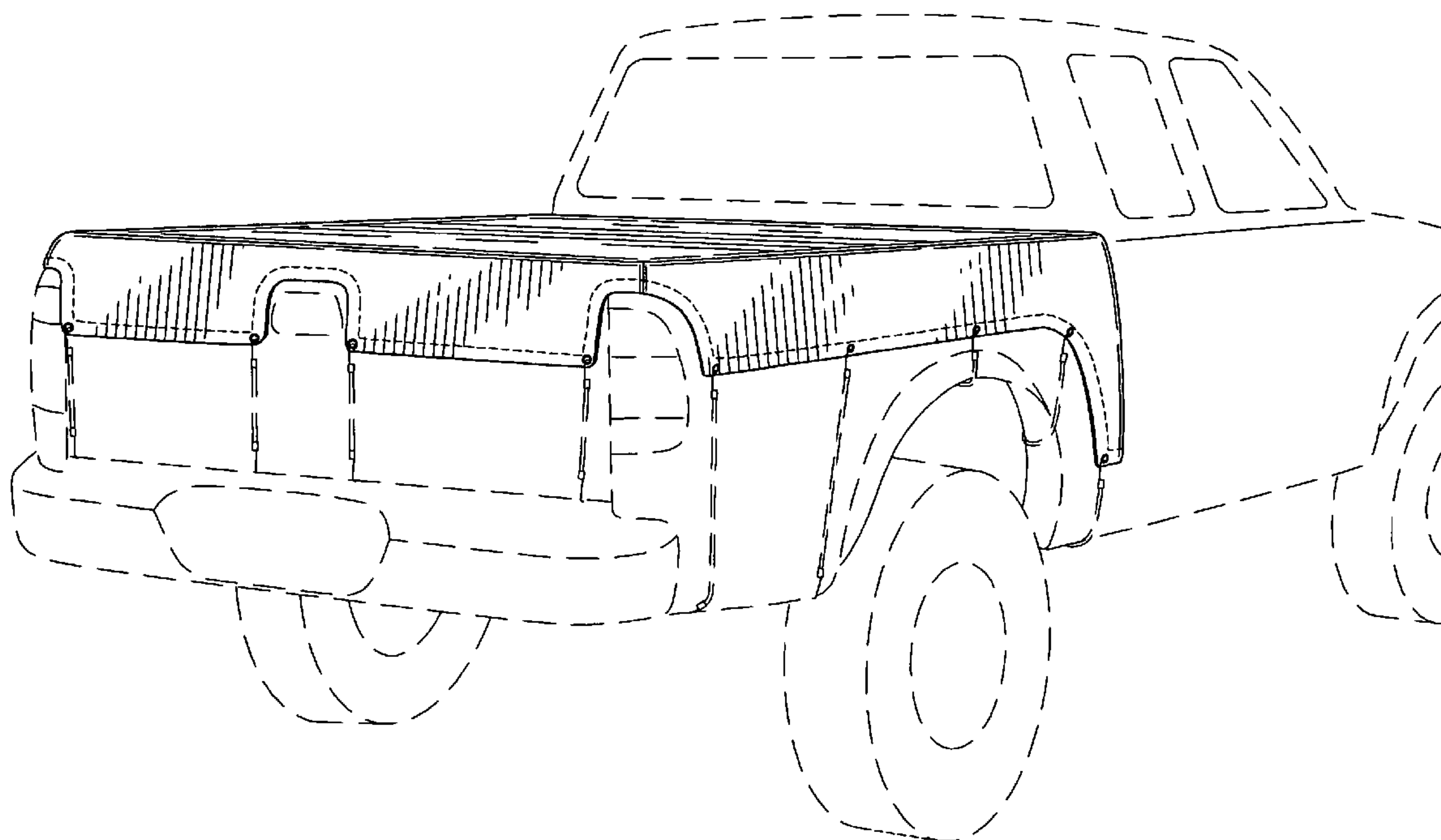

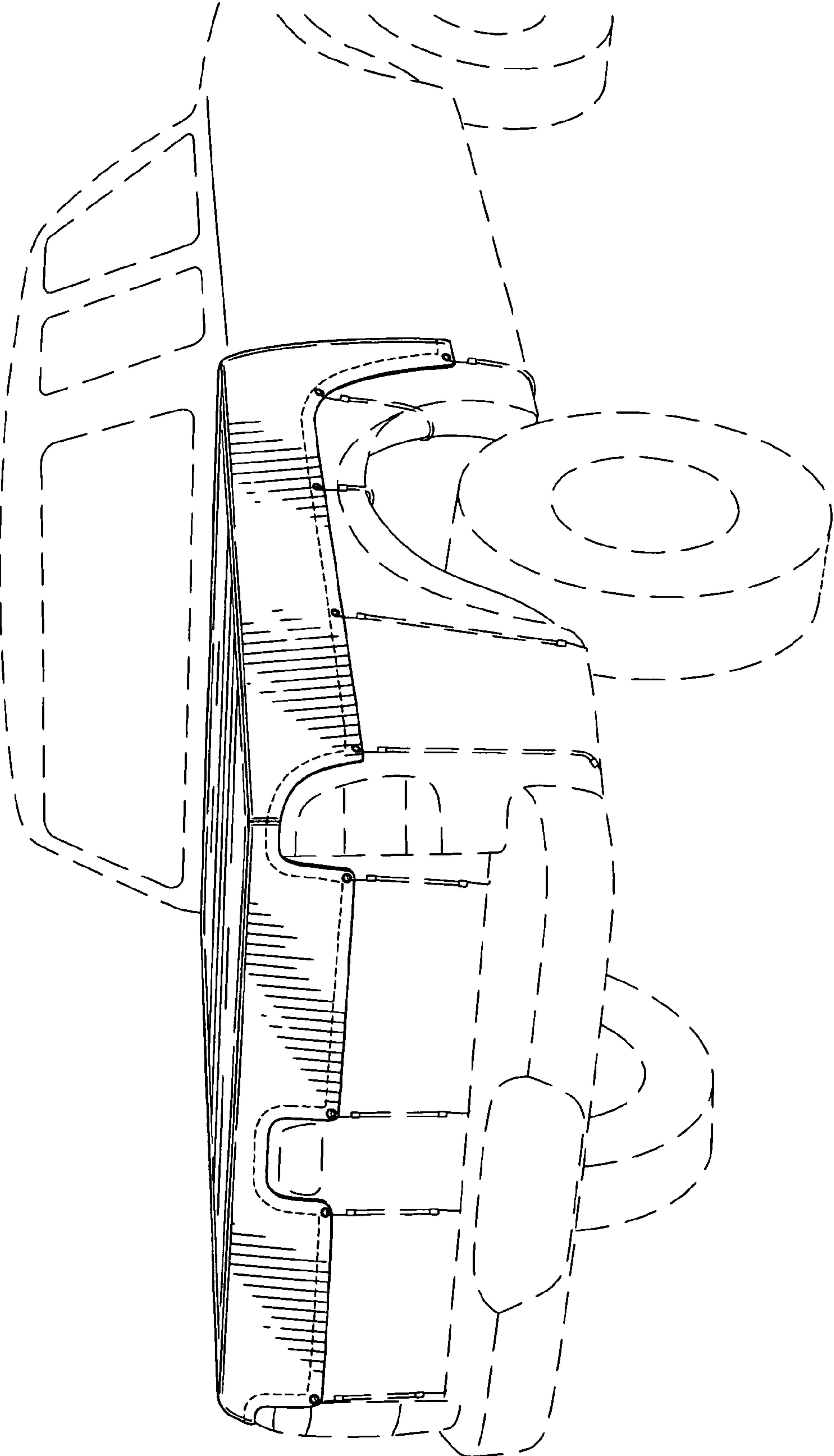

FIG. 1

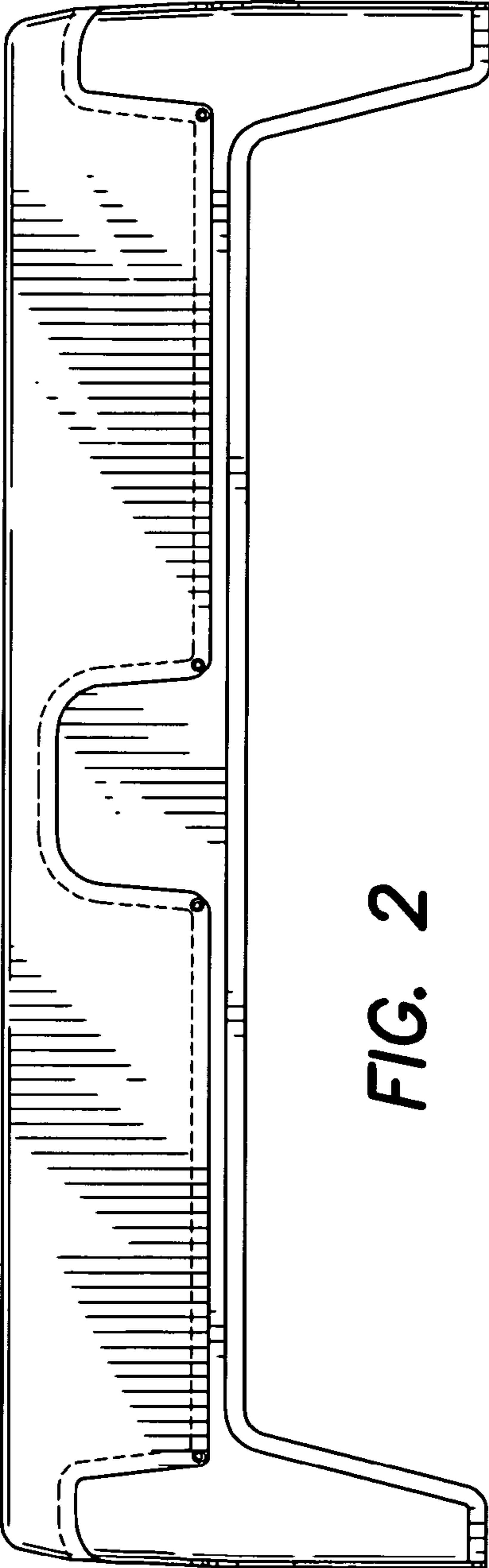

FIG. 2

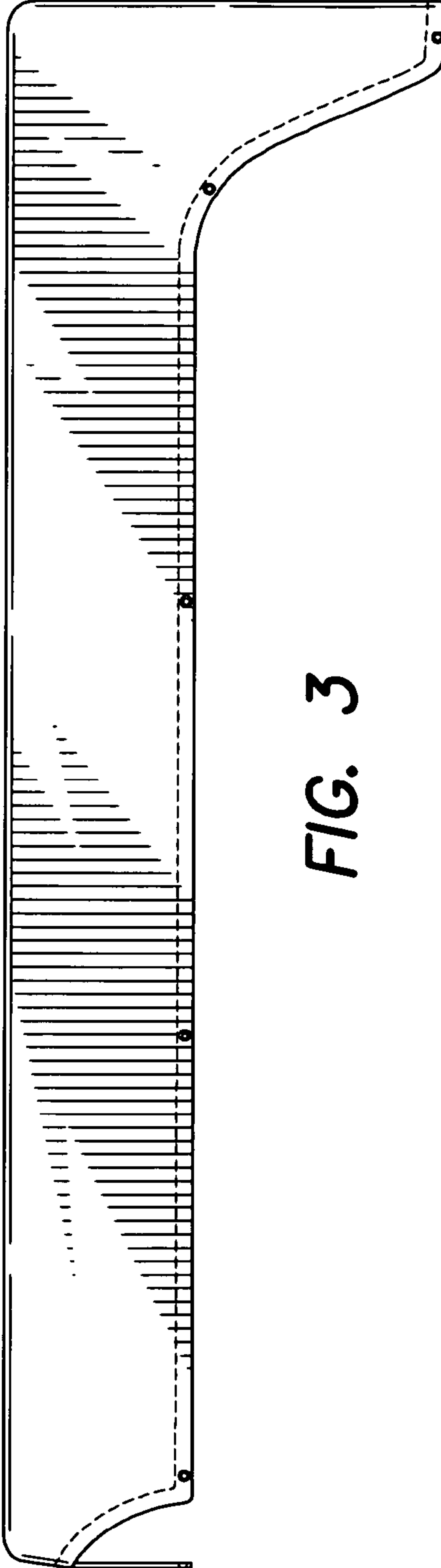

FIG. 3

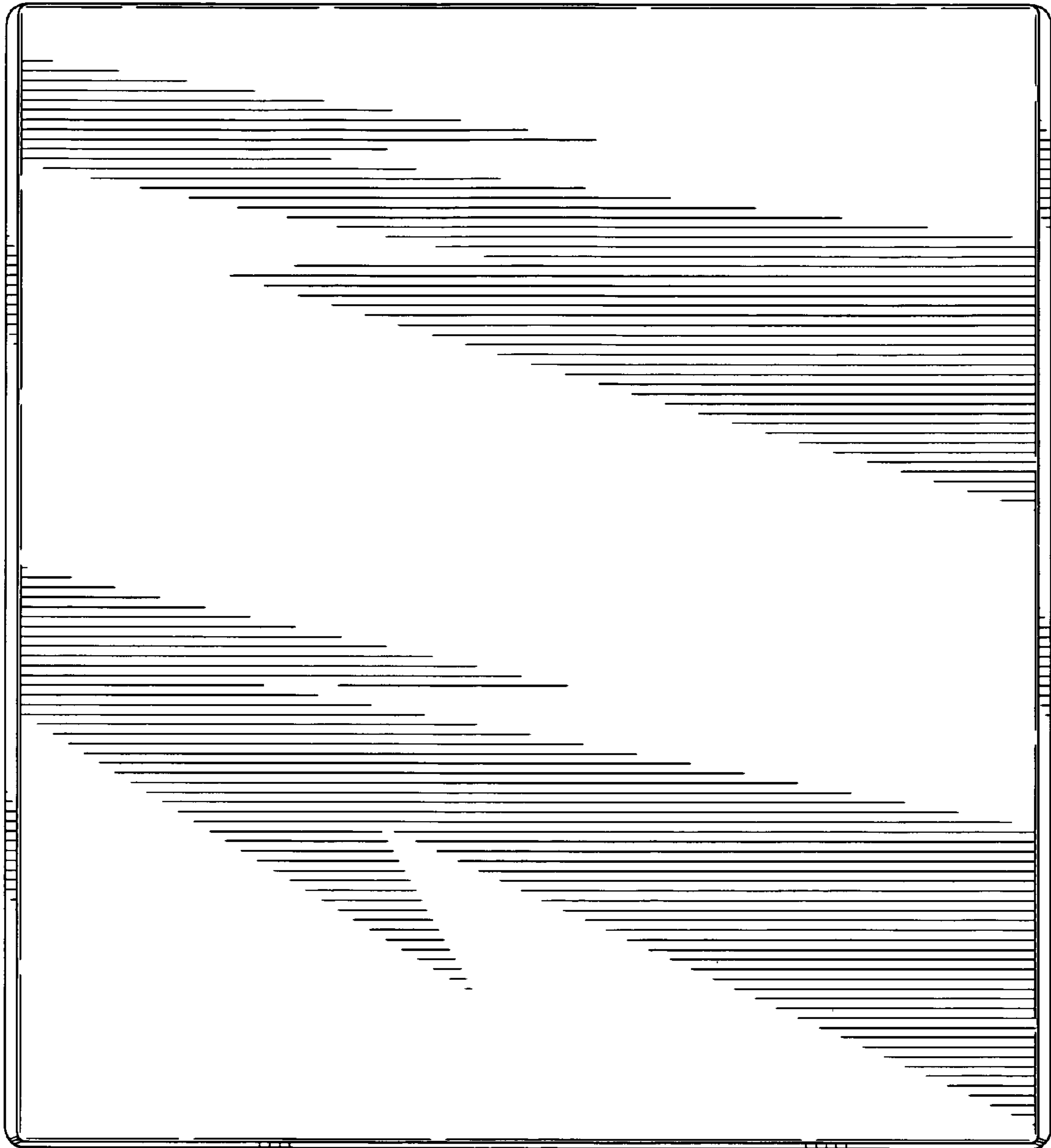

FIG. 4

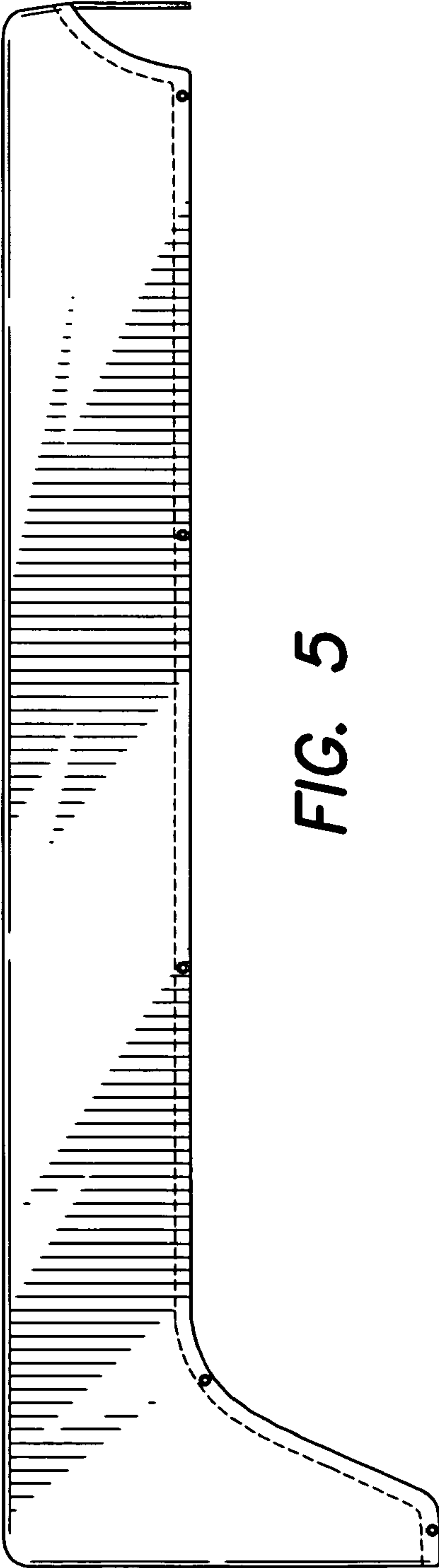

FIG. 5

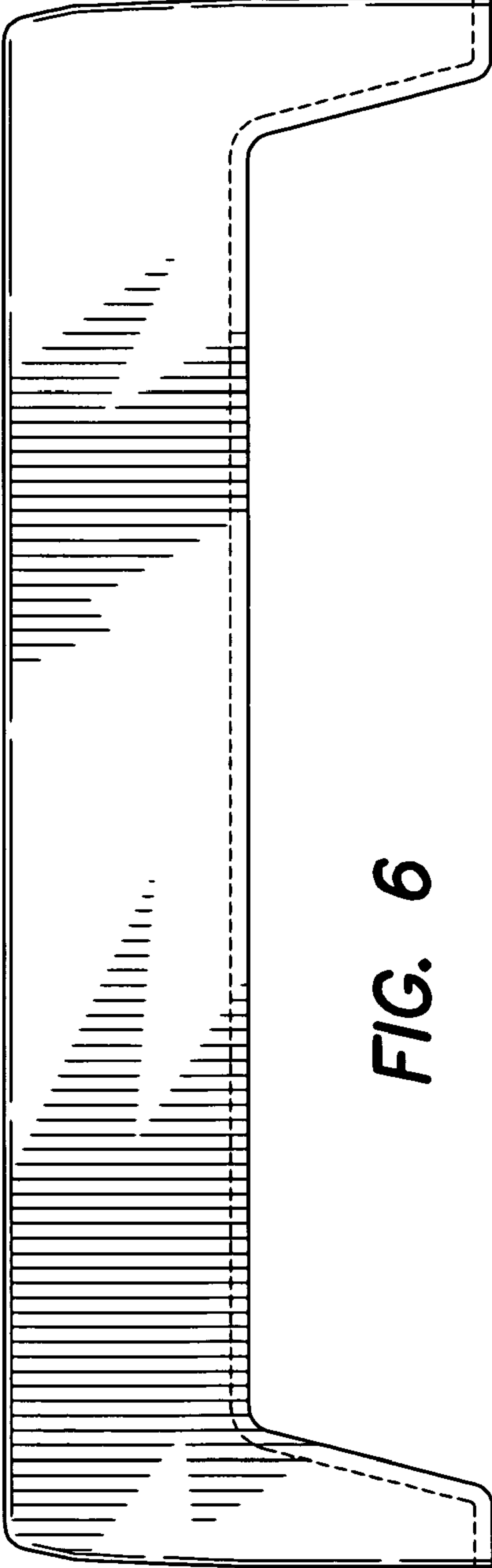

FIG. 6

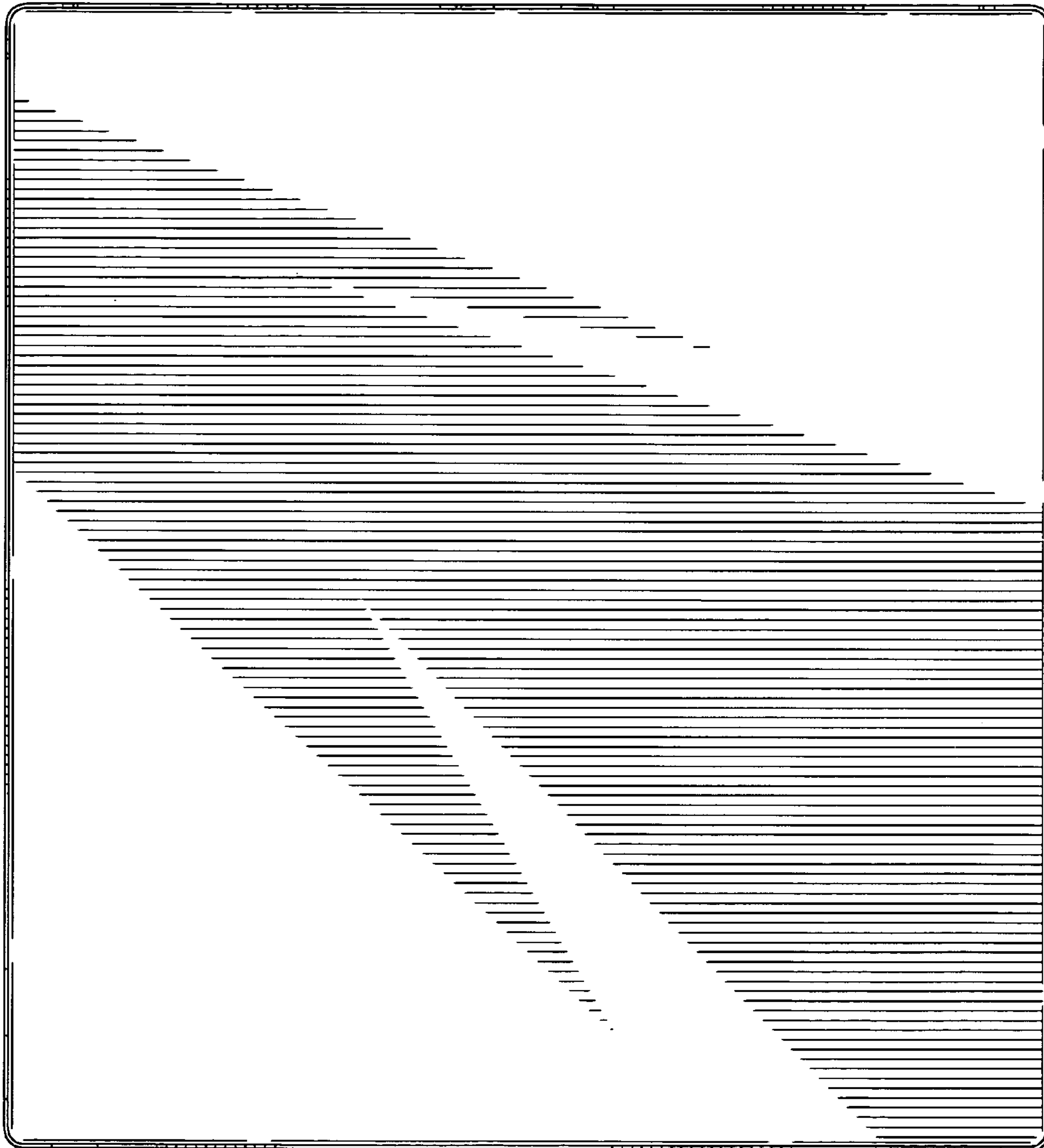

FIG. 7