



US00D584571S

(12) **United States Design Patent**  
**Roth et al.**

(10) **Patent No.:** **US D584,571 S**  
(45) **Date of Patent:** **\*\* Jan. 13, 2009**

(54) **CONTAINER**

(76) Inventors: **Donna Roth**, 10 Cordage Park Cir.,  
Suite 212, Plymouth, MA (US) 02360;  
**Henry Roth**, 10 Cordage Park Cir., Suite  
212, Plymouth, MA (US) 02360

(\*\*) Term: **14 Years**

(21) Appl. No.: **29/322,819**

(22) Filed: **Aug. 13, 2008**

**Related U.S. Application Data**

(62) Division of application No. 29/281,556, filed on Jun.  
26, 2007, now Pat. No. Des. 576,450.

(51) **LOC (9) Cl.** ..... **07-01**  
(52) **U.S. Cl.** ..... **D7/629**  
(58) **Field of Classification Search** ..... D7/510,  
D7/511, 612-615, 629, 601, 602; 220/780-806,  
220/203.1, 574-575; D9/428, 549, 559,  
D9/435, 446

See application file for complete search history.

(56) **References Cited**

**U.S. PATENT DOCUMENTS**

D180,049 S 4/1957 Tupper  
D208,935 S \* 10/1967 Marien et al. .... D7/321  
D421,547 S 3/2000 Demers

D447,917 S 9/2001 Miller et al.  
D482,936 S 12/2003 Miller et al.  
D527,588 S 9/2006 de Groote et al.  
D531,461 S 11/2006 Littmann

\* cited by examiner

*Primary Examiner*—Terry A Wallace  
(74) *Attorney, Agent, or Firm*—Garcia-Zamor IP Law; Ruy  
M. Garcia-Zamor

(57) **CLAIM**

We claim a new ornamental design for a container, as shown  
and described.

**DESCRIPTION**

FIG. 1 is a perspective view of a container showing our new  
design.

FIG. 2 is a right side elevation view thereof, the opposite side  
being a mirror image.

FIG. 3 is a front elevation view thereof.

FIG. 4 is a top plan view thereof.

FIG. 5 is a rear elevation view thereof; and,

FIG. 6 is a bottom plan view thereof.

The broken lines are for illustrative purposes only and form  
no part of the claimed design.

**1 Claim, 3 Drawing Sheets**

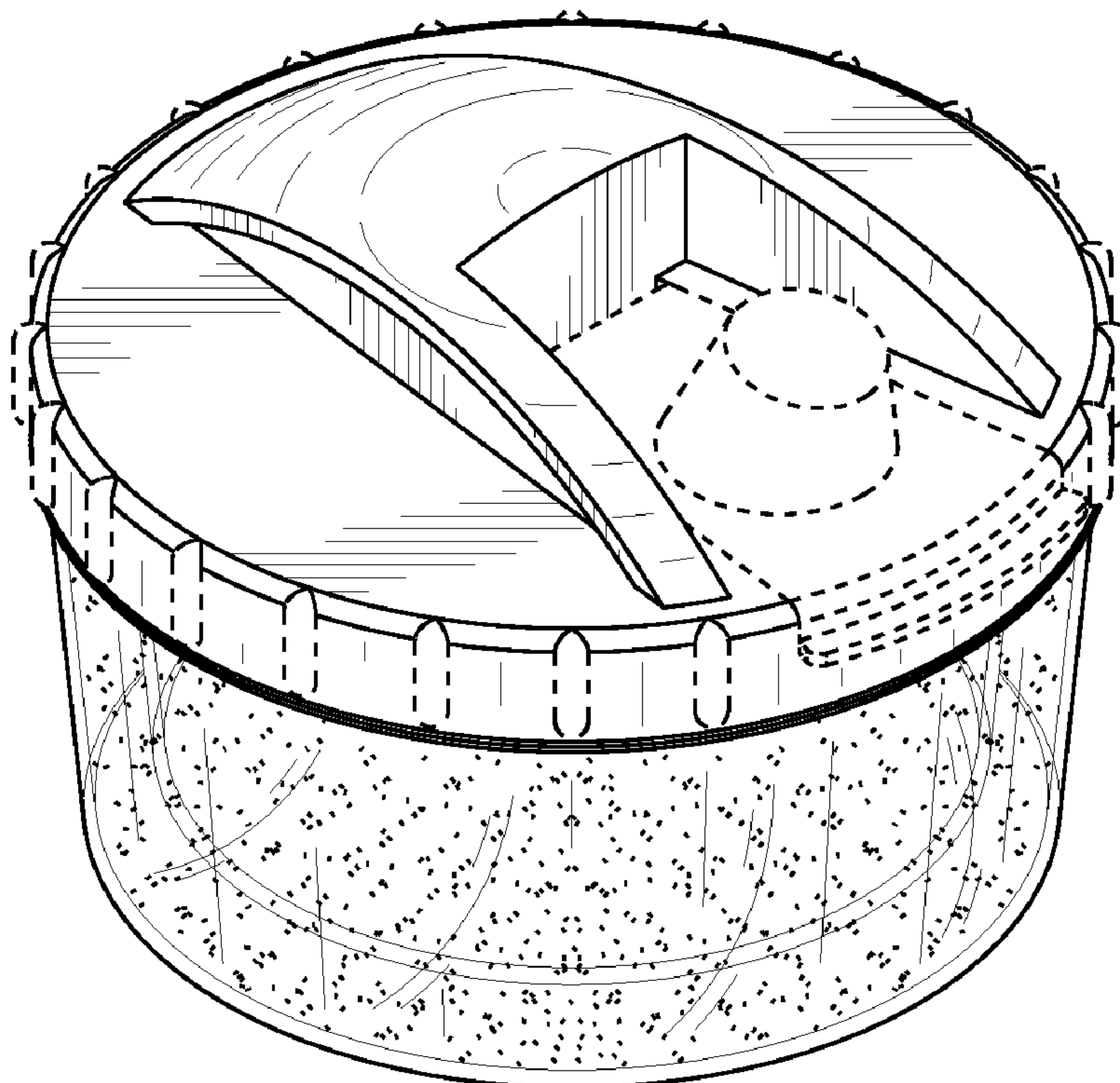

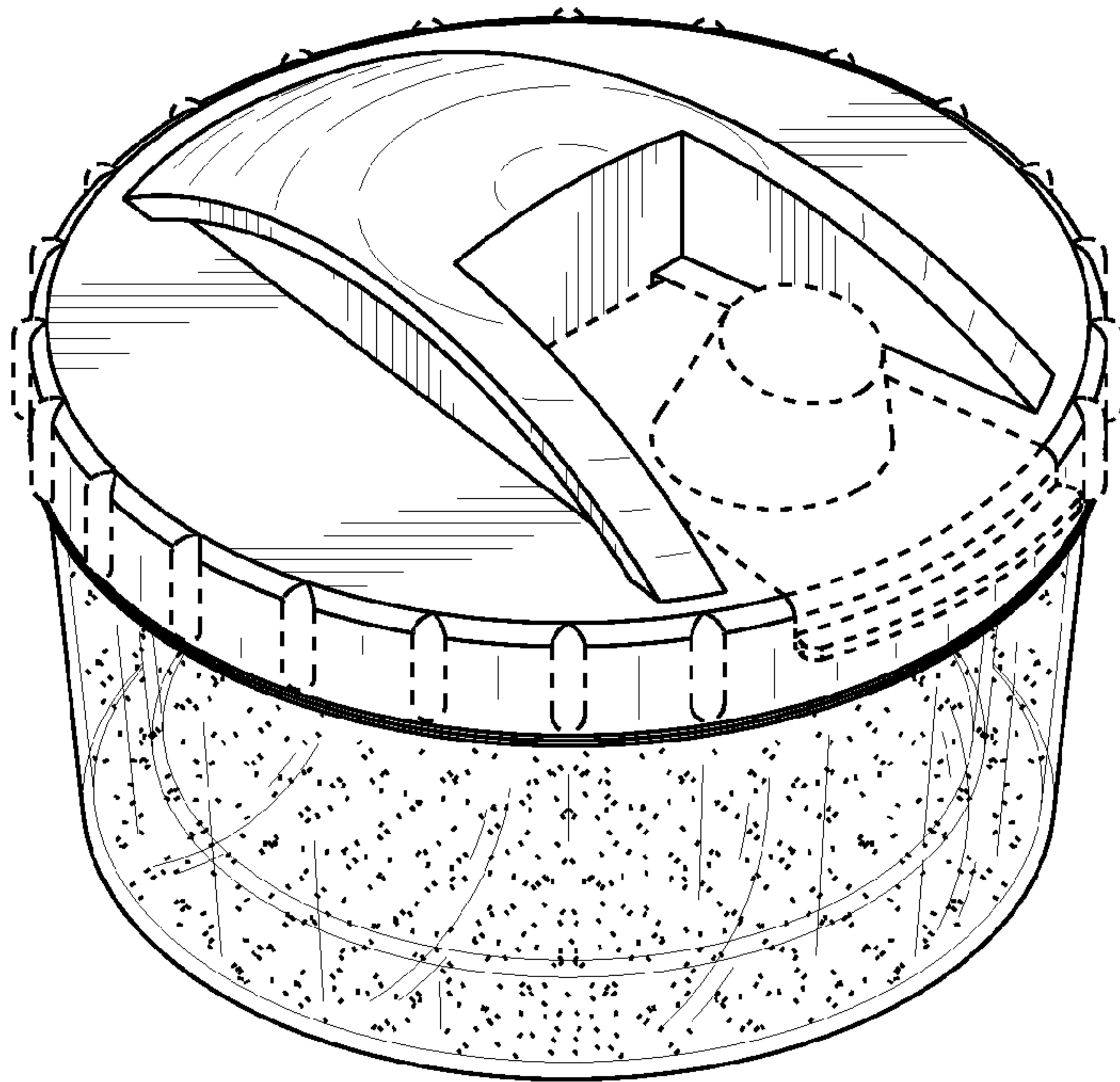

FIG. 1

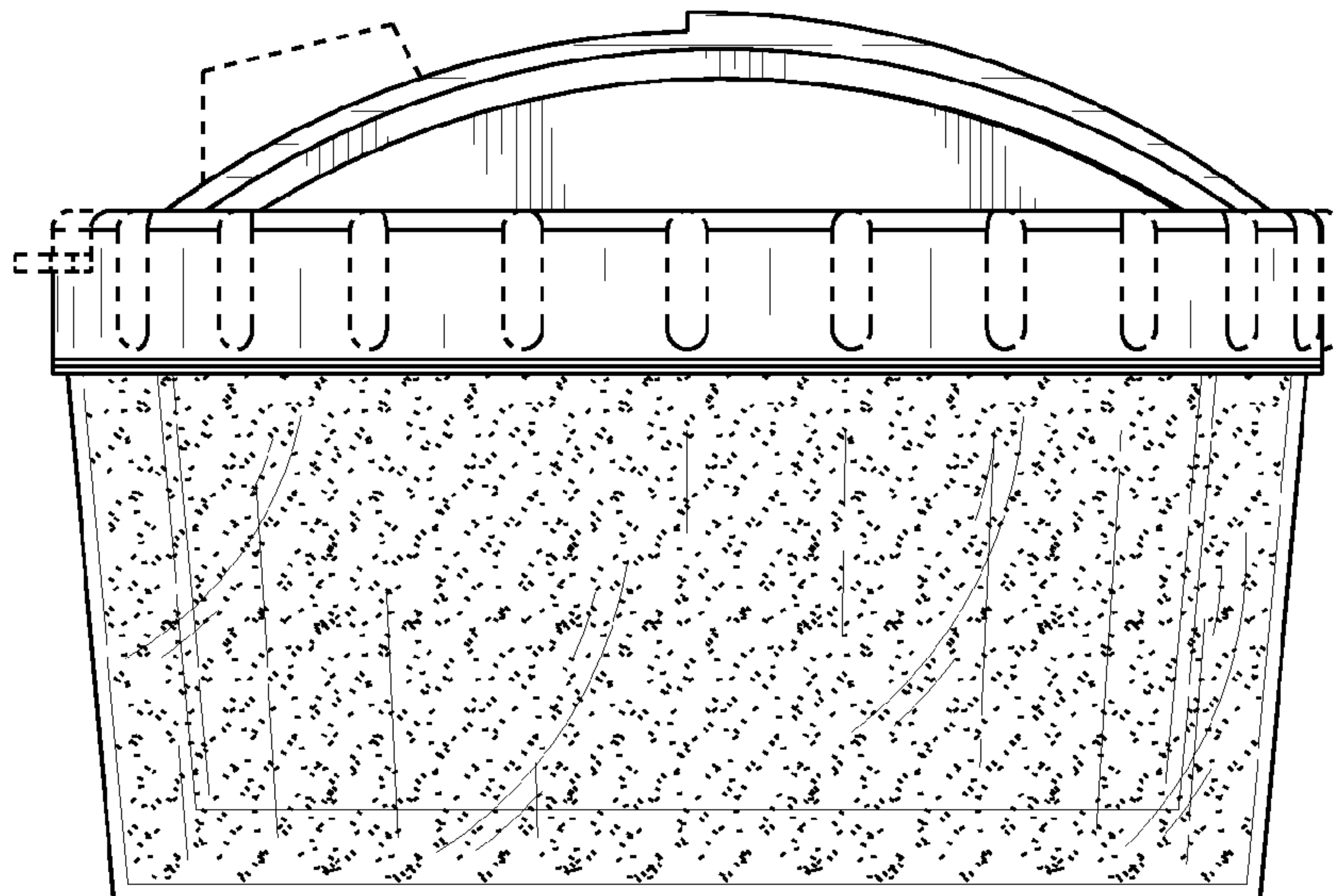

FIG. 2

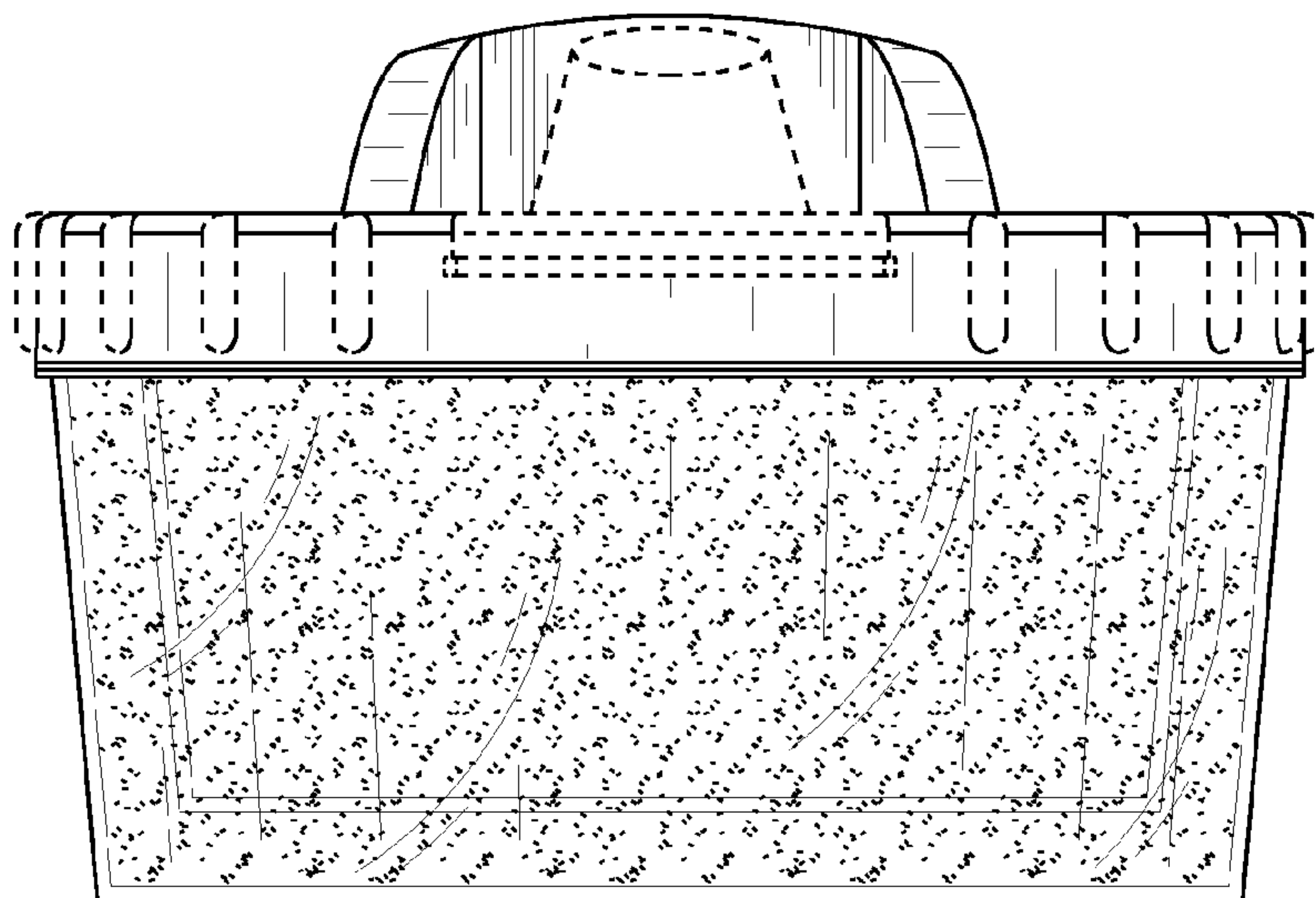

FIG. 3

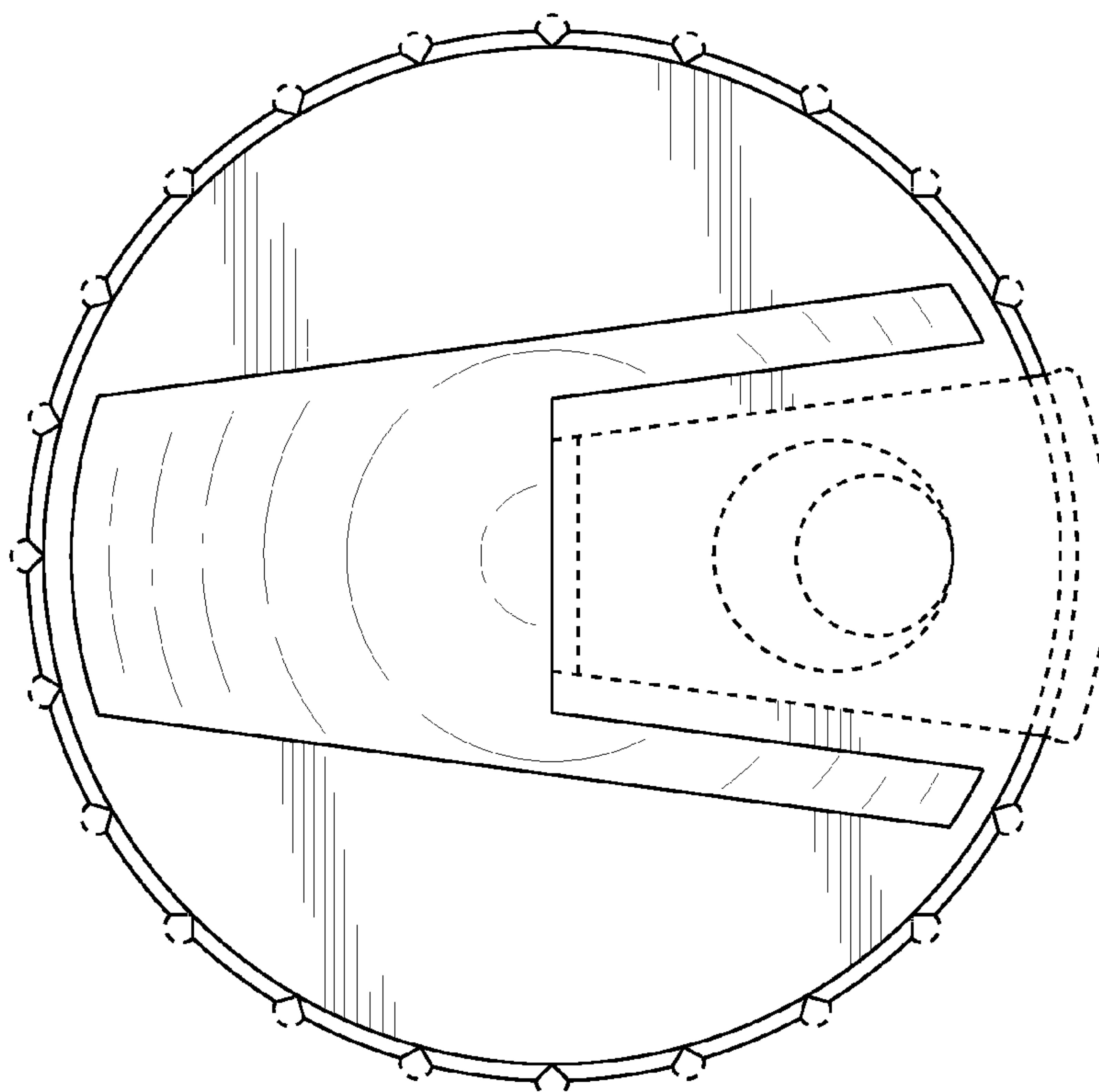

FIG. 4



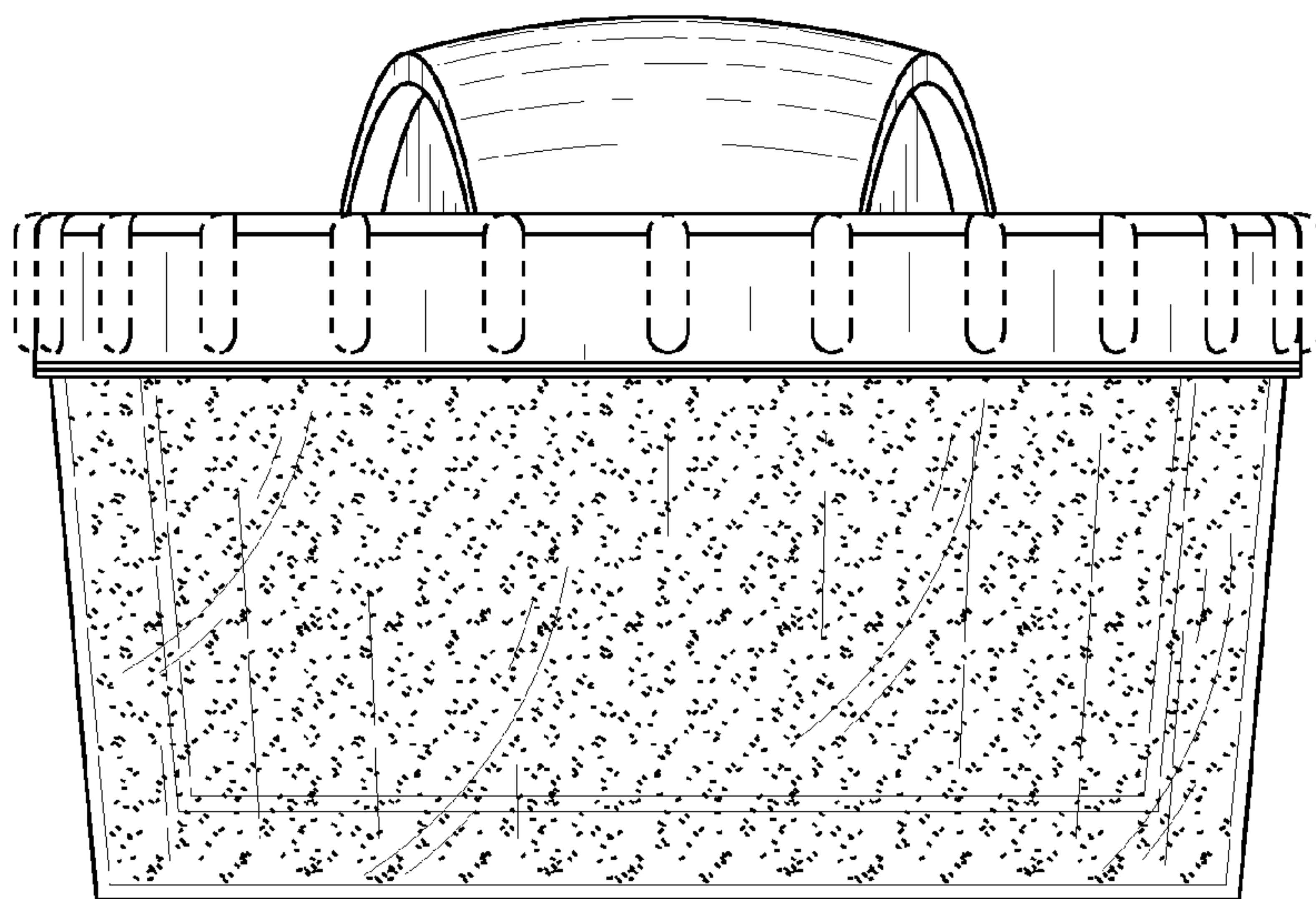

FIG. 5

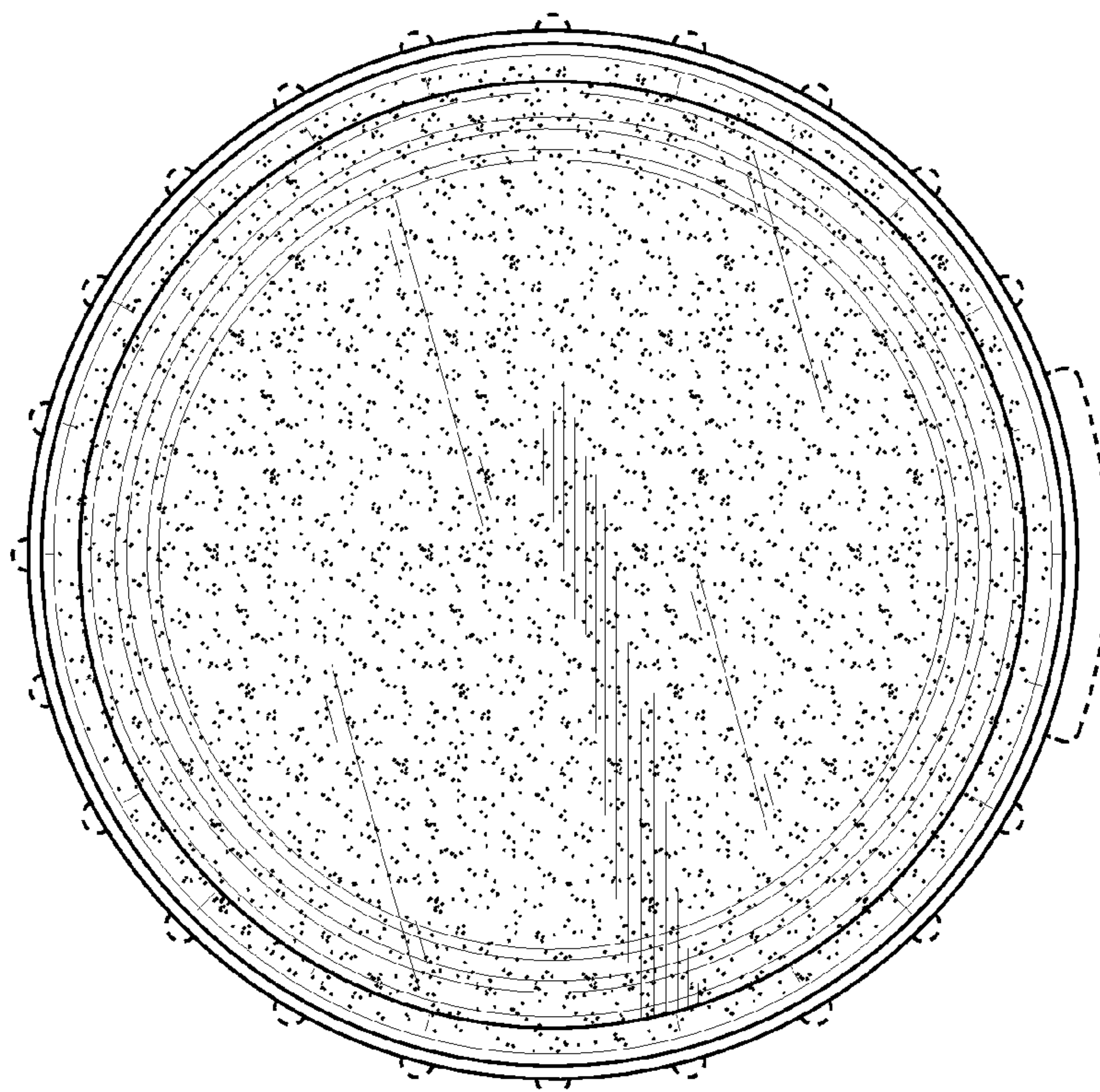

FIG. 6