



US00D584558S

(12) **United States Design Patent**
Bodum

(10) **Patent No.:** **US D584,558 S**

(45) **Date of Patent:** **** Jan. 13, 2009**

(54) **DOUBLE WALL CHOCOLATE JUG**

D563,713 S * 3/2008 Bodum D7/319
D566,454 S * 4/2008 Bodum D7/319

(75) Inventor: **Jørgen Bodum**, Meggen (CH)

* cited by examiner

(73) Assignee: **Pi-Design, AG**, Triengen (CH)

Primary Examiner—Antoine D Davis

(**) Term: **14 Years**

(74) *Attorney, Agent, or Firm*—Cowan, Liebowitz & Latman, PC

(21) Appl. No.: **29/283,390**

(57) **CLAIM**

(22) Filed: **Aug. 13, 2007**

The ornamental design for a double wall chocolate jug, as shown and described.

(30) **Foreign Application Priority Data**

Feb. 13, 2007 (DK) DA 2007 00039

DESCRIPTION

(51) **LOC (9) Cl.** **07-01**

FIG. 1 is a perspective view of the double wall chocolate jug, showing my design thereof;

(52) **U.S. Cl.** **D7/319; D7/317**

FIG. 2 is a front view thereof;

(58) **Field of Classification Search** D7/300–322,
D7/516, 533, 536; D23/207, 209; 99/297,
99/319; 210/282, 635; 222/164, 165, 465.1,
222/466

FIG. 3 is a back view thereof;

FIG. 4 is a right side view thereof;

FIG. 5 is a left side view thereof;

See application file for complete search history.

FIG. 6 is a top view thereof;

FIG. 7 is a bottom view thereof; and,

FIG. 8 is a cross-sectional view thereof taken along line 8—8 of FIG. 6.

(56) **References Cited**

U.S. PATENT DOCUMENTS

D500,626 S * 1/2005 Ranzoni D7/317

D557,978 S * 12/2007 Bodum D7/399

1 Claim, 8 Drawing Sheets

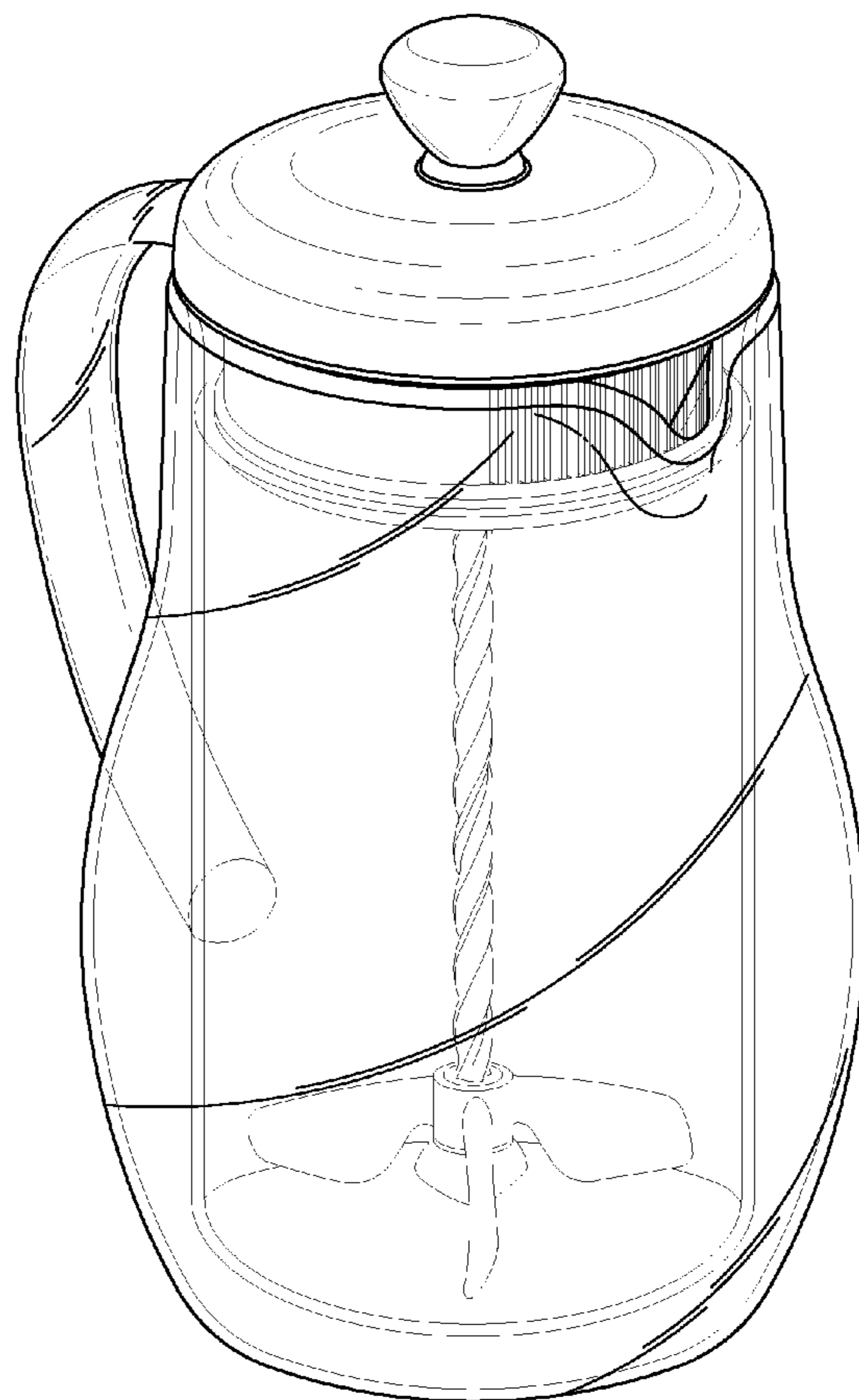

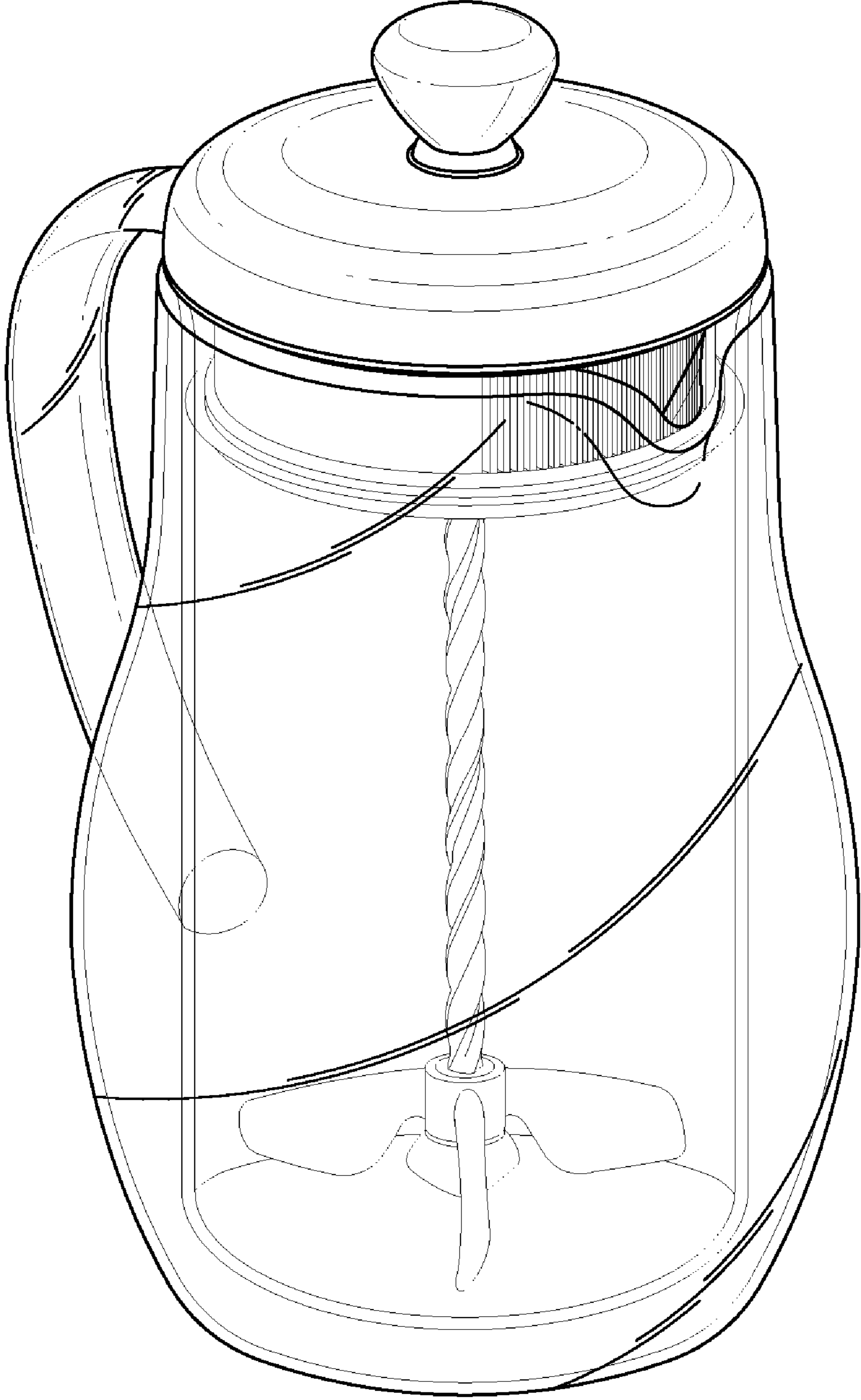

FIG. 1

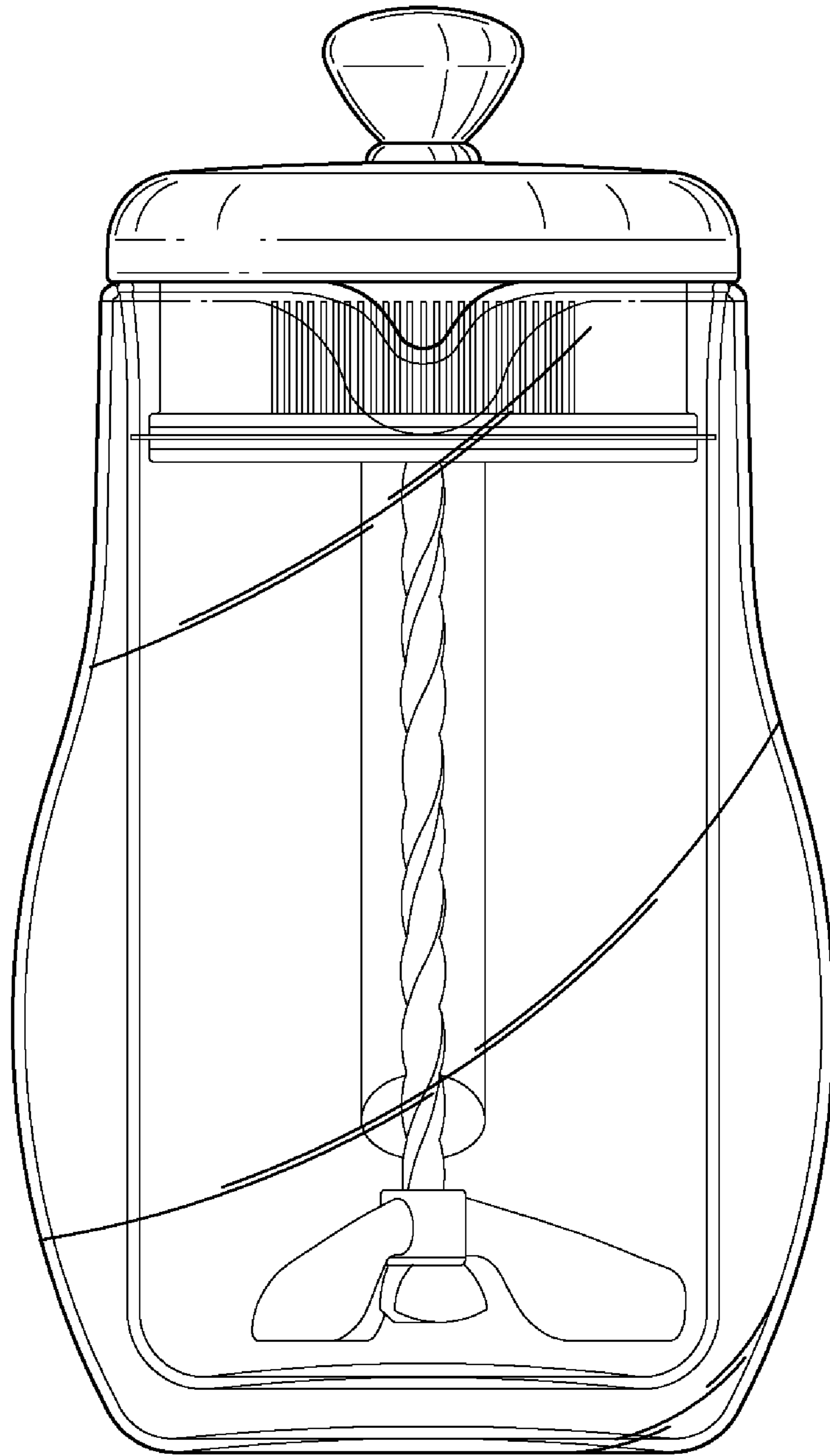

FIG. 2

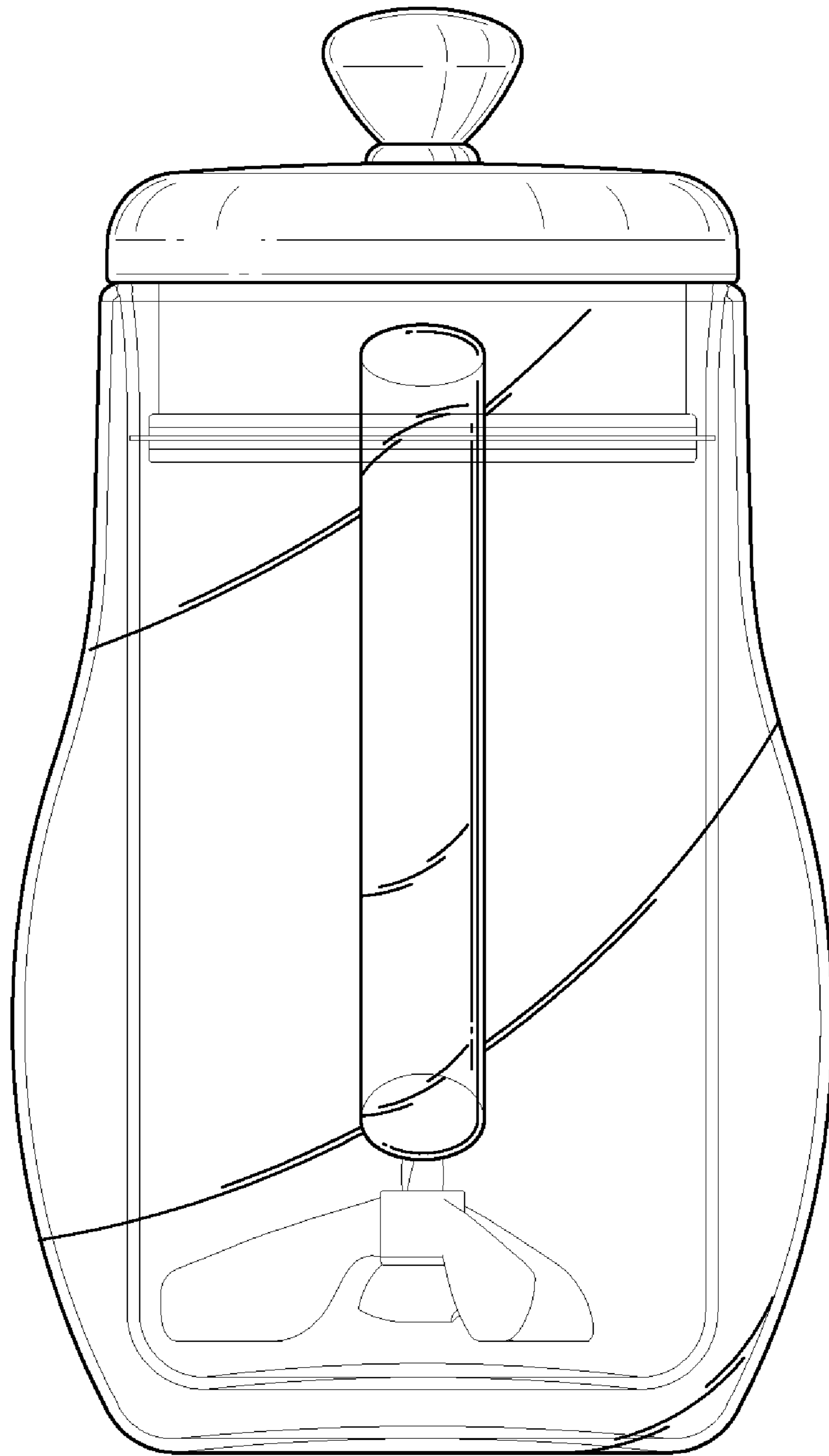

FIG. 3

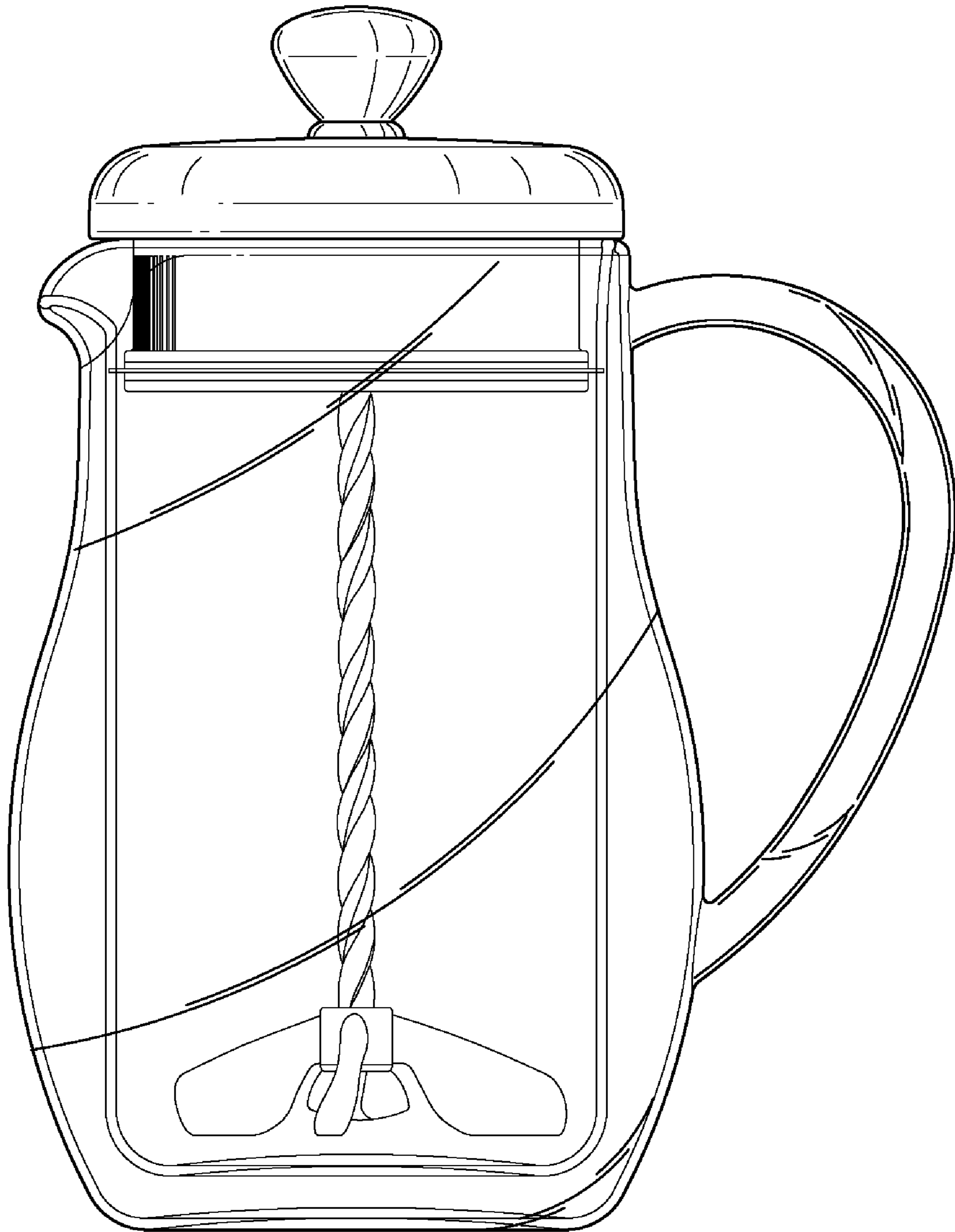

FIG. 4

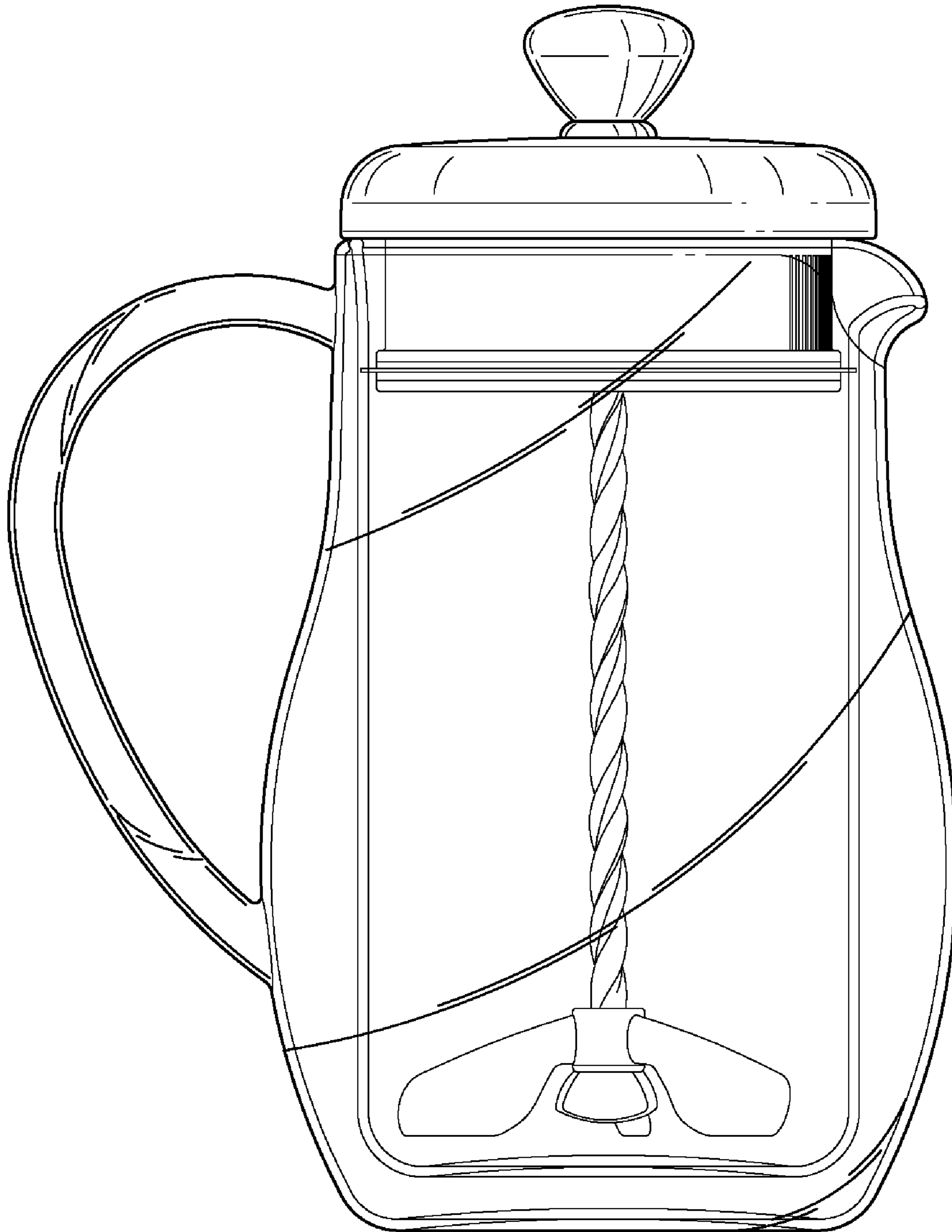

FIG. 5

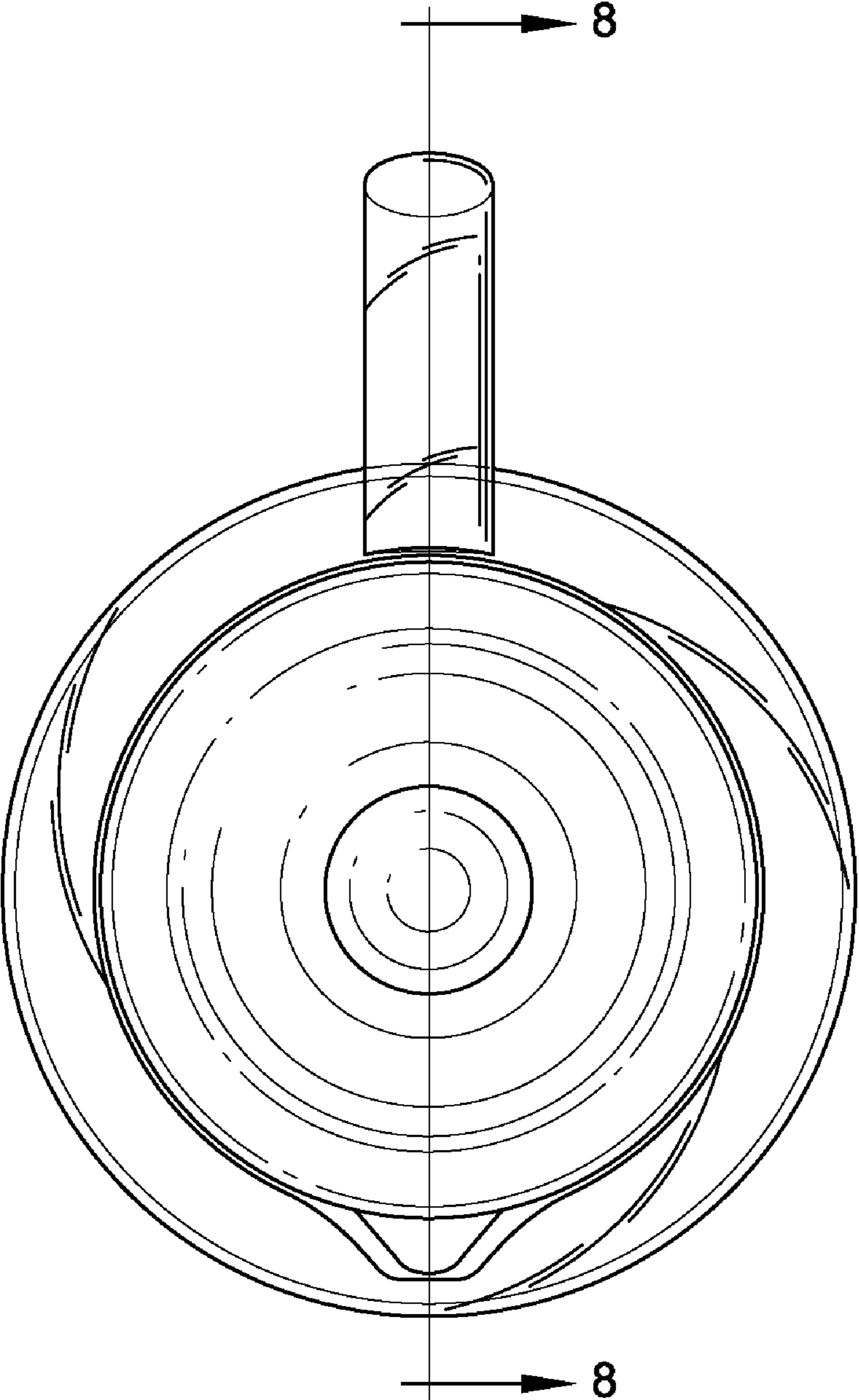

FIG. 6

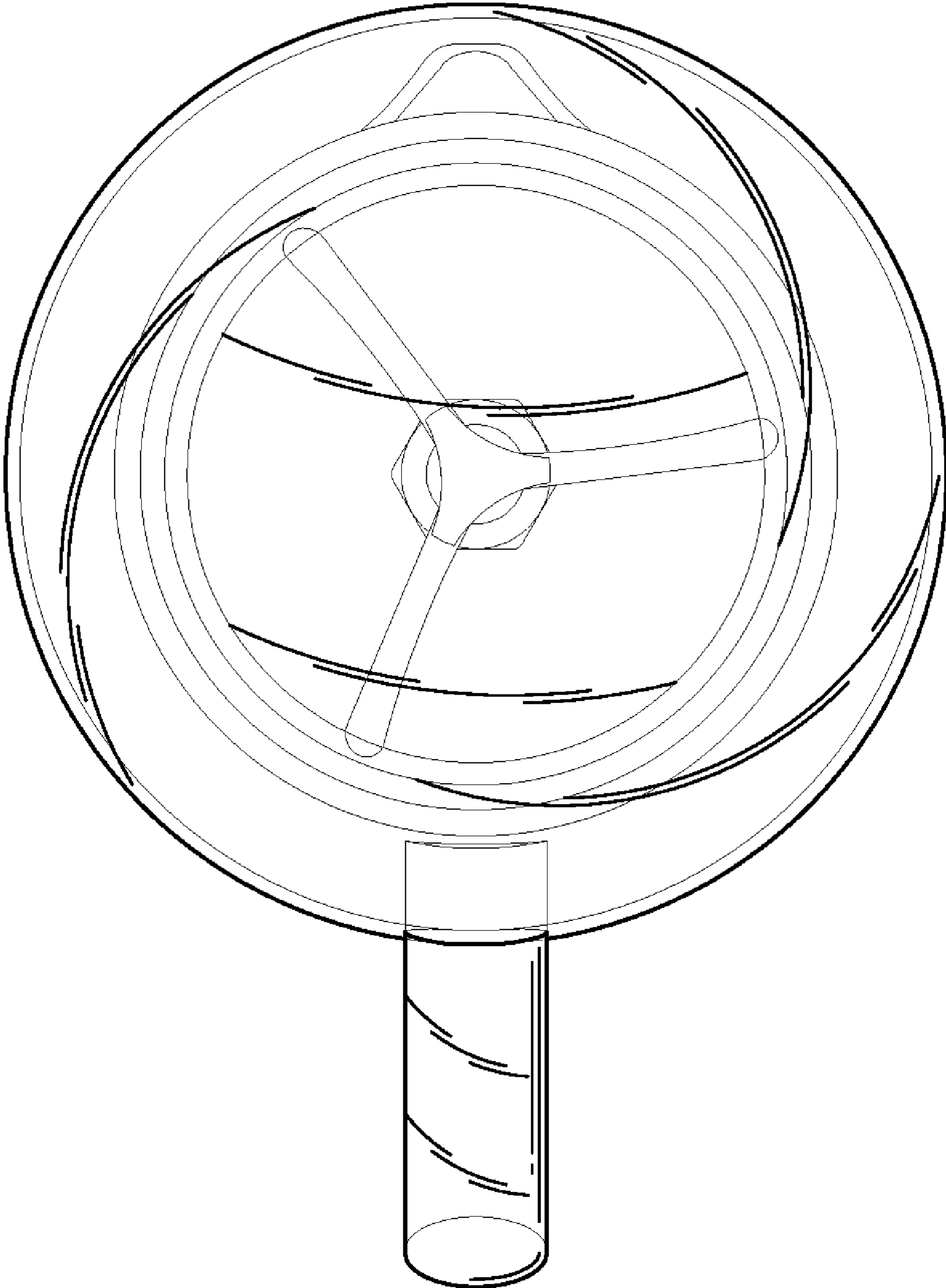

FIG. 7

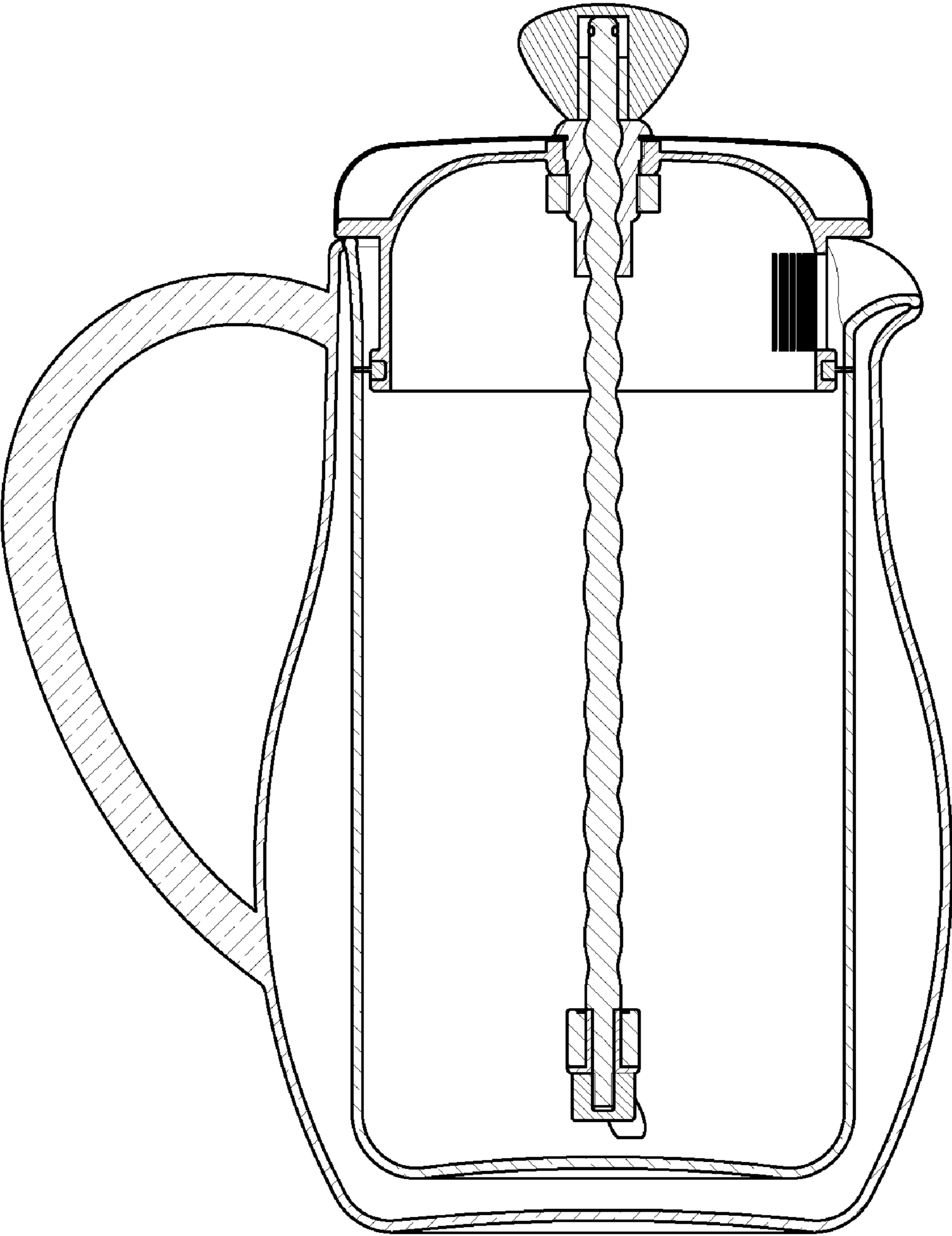

FIG. 8