



US00D584479S

(12) **United States Design Patent**  
**Jones et al.**

(10) **Patent No.:** **US D584,479 S**

(45) **Date of Patent:** **\*\* Jan. 13, 2009**

(54) **WEARABLE SEATING CUSHION**

D500,393 S \* 12/2004 Beacham et al. .... D29/100  
D546,029 S \* 7/2007 Rindle ..... D2/738

(76) Inventors: **Cortrell Jones**, 3769 silver Chalice Dr.,  
Memphis, TN (US) 38115; **Gloria**  
**Jones**, 3769 Silver Chalice Dr.,  
Memphis, TN (US) 38115

\* cited by examiner

*Primary Examiner*—Ian Simmons  
*Assistant Examiner*—Anna J Burmeister

(74) *Attorney, Agent, or Firm*—Wyatt, Tarrant & Combs, LLP

(\*\*) Term: **14 Years**

(21) Appl. No.: **29/297,358**

(57) **CLAIM**

(22) Filed: **Nov. 9, 2007**

The ornamental design for a wearable seating cushion, as shown and described.

(51) **LOC (9) Cl.** ..... **02-01**

(52) **U.S. Cl.** ..... **D2/712; D29/101.5**

(58) **Field of Classification Search** ..... D2/712,  
D2/624–625, 731, 738, 742; 2/400, 413,  
2/406, 407, 238, 401; D29/101.5; D6/595,  
D6/596, 601

See application file for complete search history.

**DESCRIPTION**

FIG. 1 is a front perspective view of a wearable seating cushion, showing our new design;

FIG. 2 is a front elevational view thereof;

FIG. 3 is a left side elevational view thereof; whereas the right side elevational view is a mirror image;

FIG. 4 is a rear elevational view thereof;

FIG. 5 is a top plan view thereof;

FIG. 6 is a bottom plan view thereof;

FIG. 7 is a left side, rear perspective view thereof, shown in use; and,

FIG. 8 is a right side elevational view thereof, shown in use.

The broken lines shown in the drawings are for illustrative purposes only and form no part of the claimed design.

(56) **References Cited**

**U.S. PATENT DOCUMENTS**

D201,861 S *	8/1965	Cummins	.....	D29/120.1
5,497,511 A *	3/1996	Zade	.....	2/22
5,500,952 A *	3/1996	Keyes	.....	2/465
D378,469 S *	3/1997	Tremblay	.....	D2/738
5,711,029 A *	1/1998	Visco et al.	.....	2/24
5,806,087 A *	9/1998	Grotfend	.....	2/1
5,954,564 A *	9/1999	Ganz	.....	450/99
6,023,789 A *	2/2000	Wilson et al.	.....	2/228
6,070,273 A *	6/2000	Sgro	.....	2/455

**1 Claim, 5 Drawing Sheets**

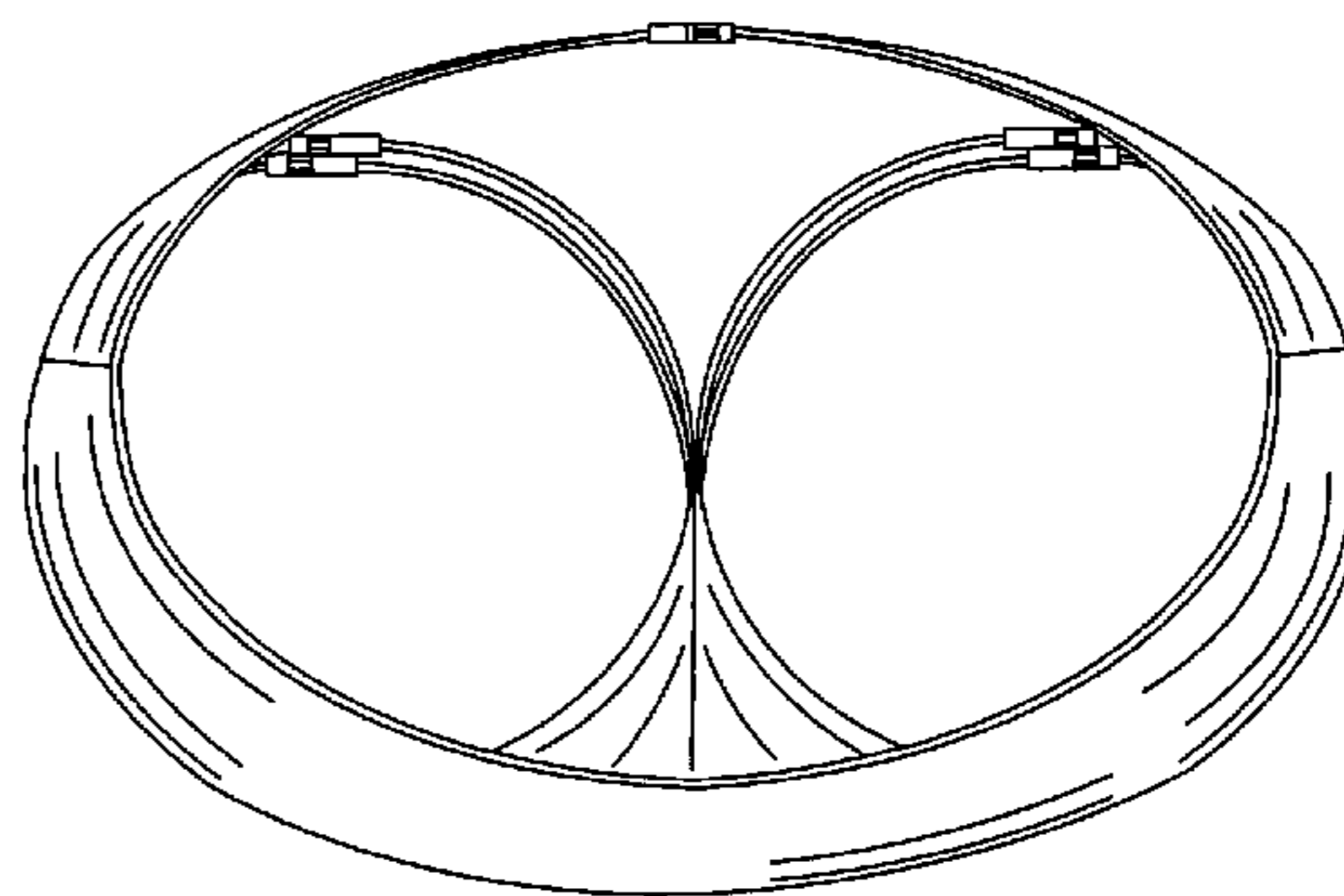
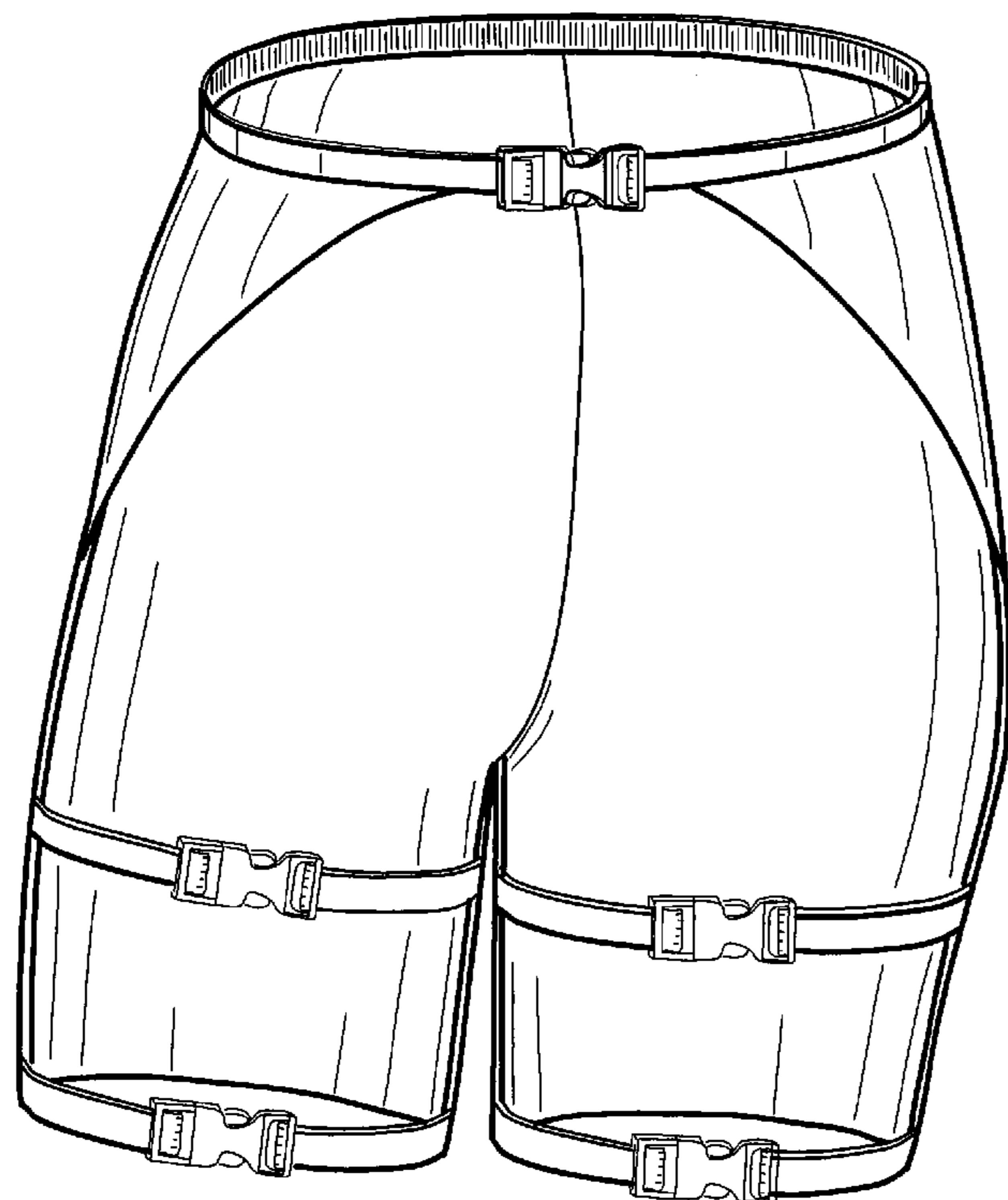

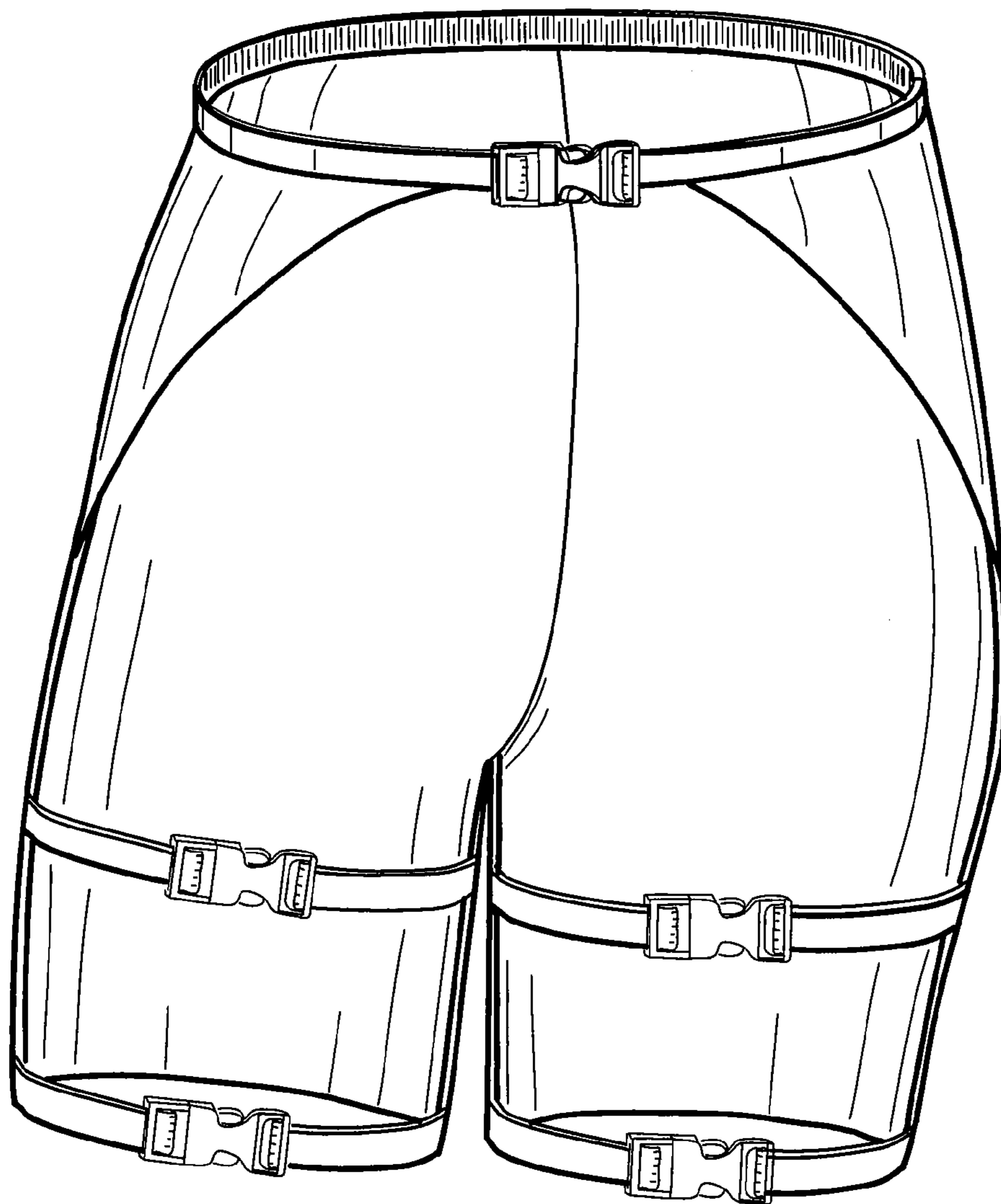

FIG. 1

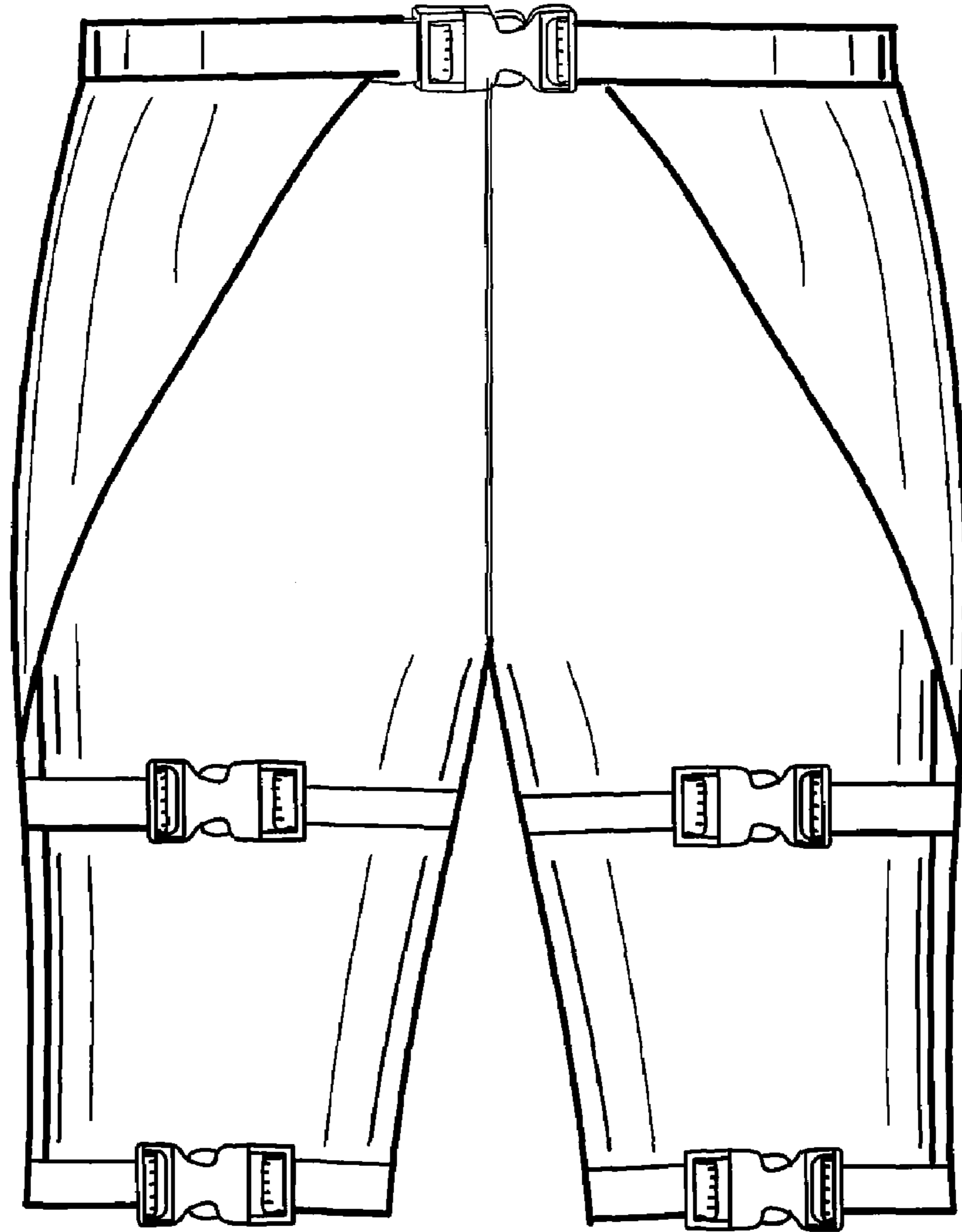

FIG. 2

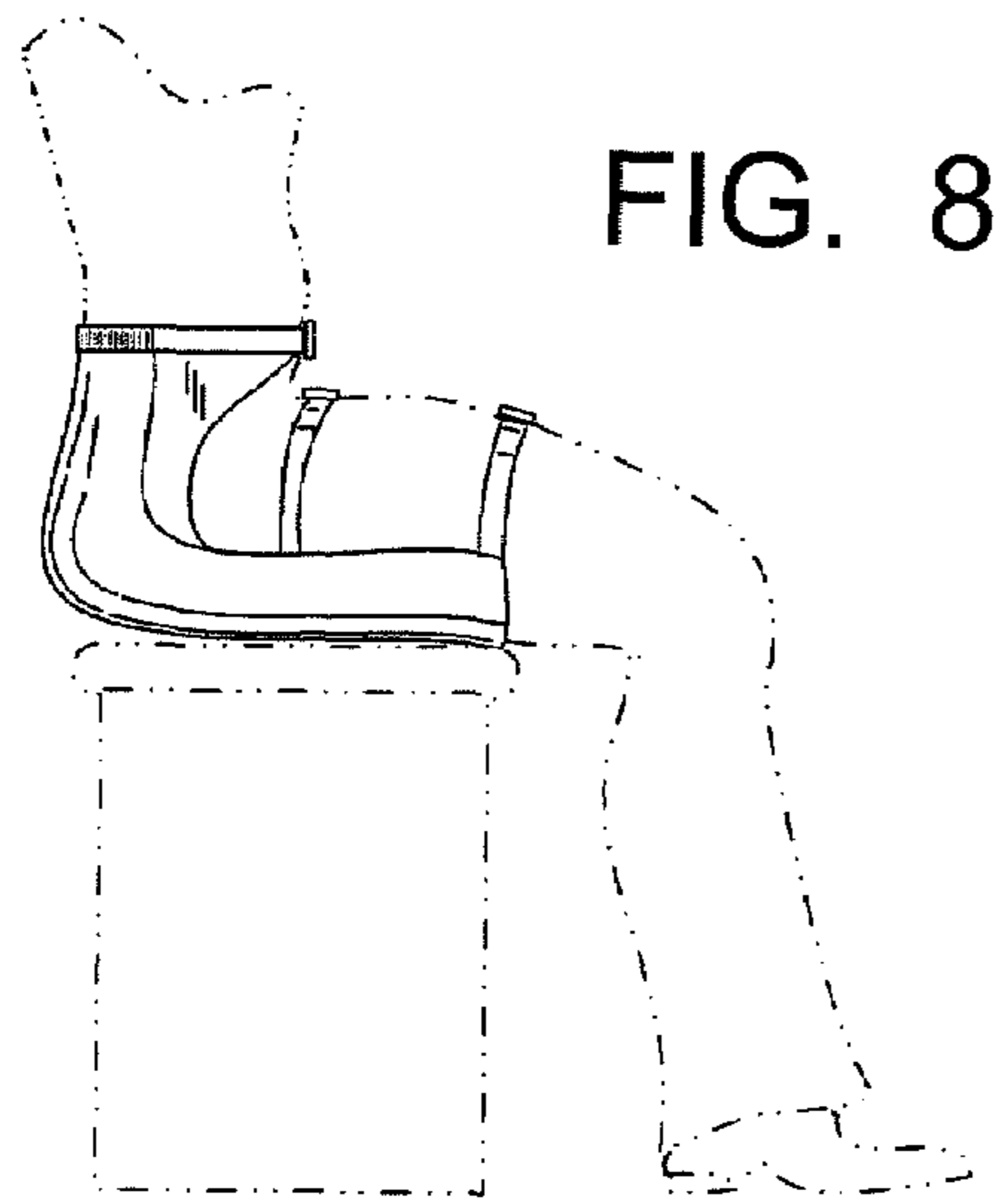

FIG. 8

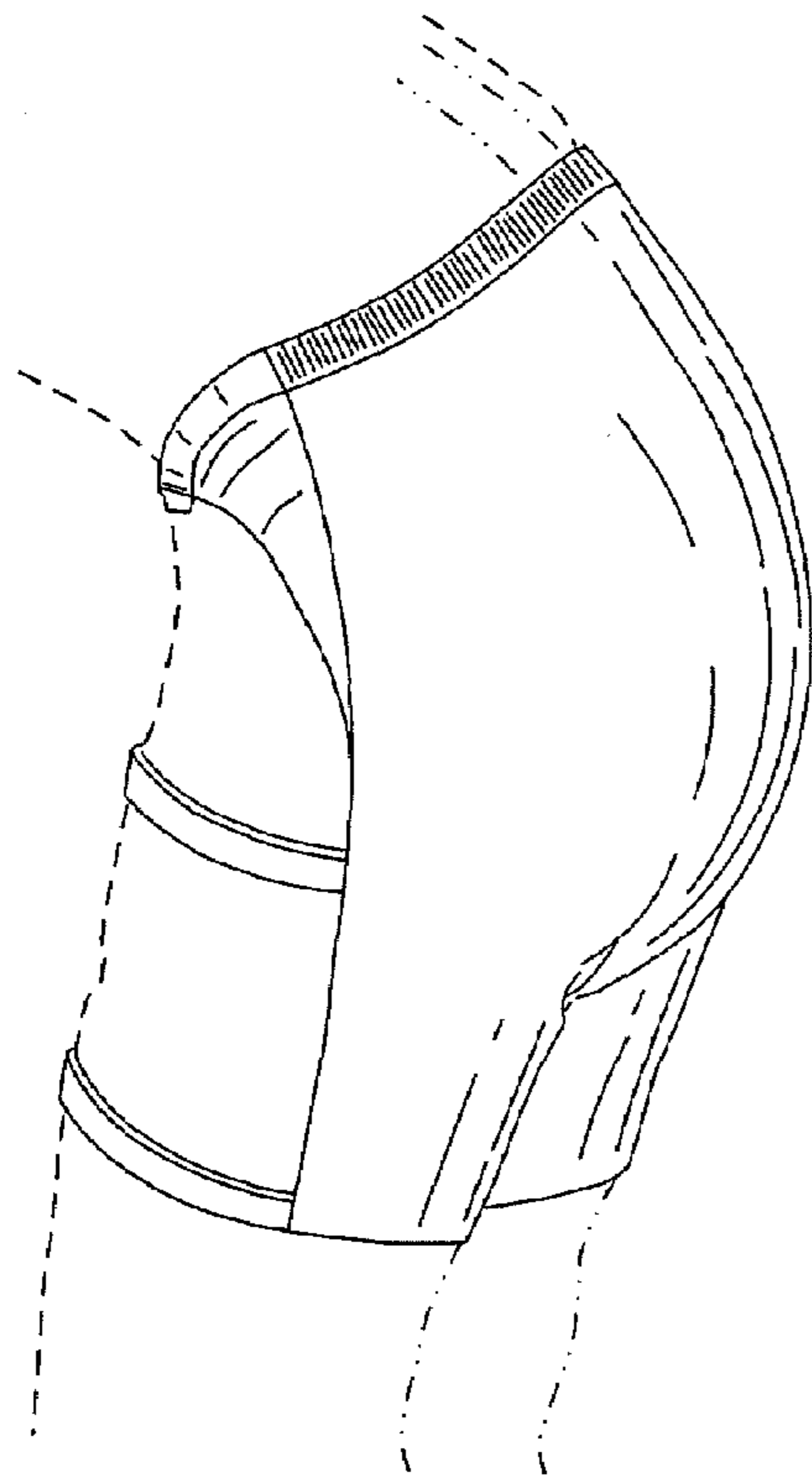

FIG. 7

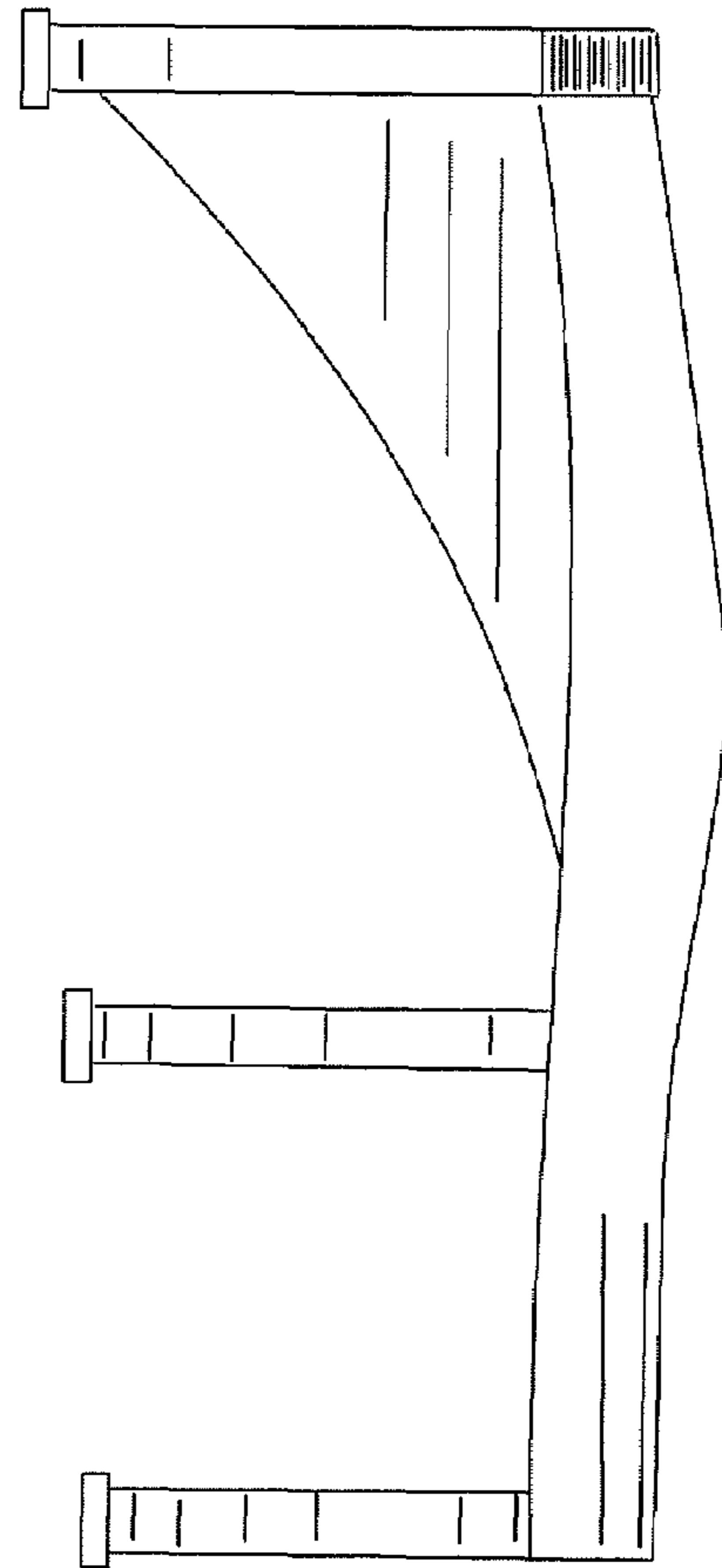

FIG. 3

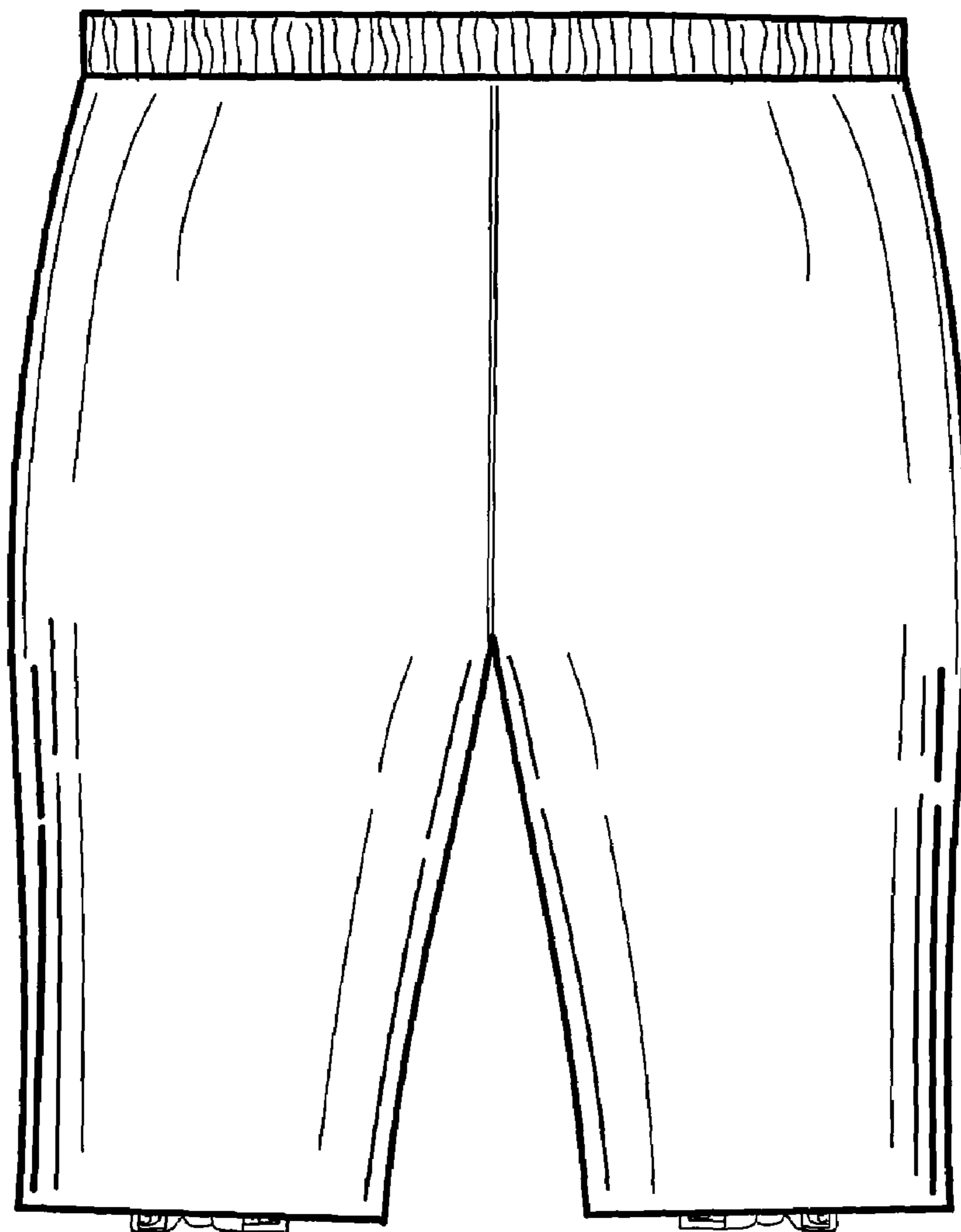

FIG. 4

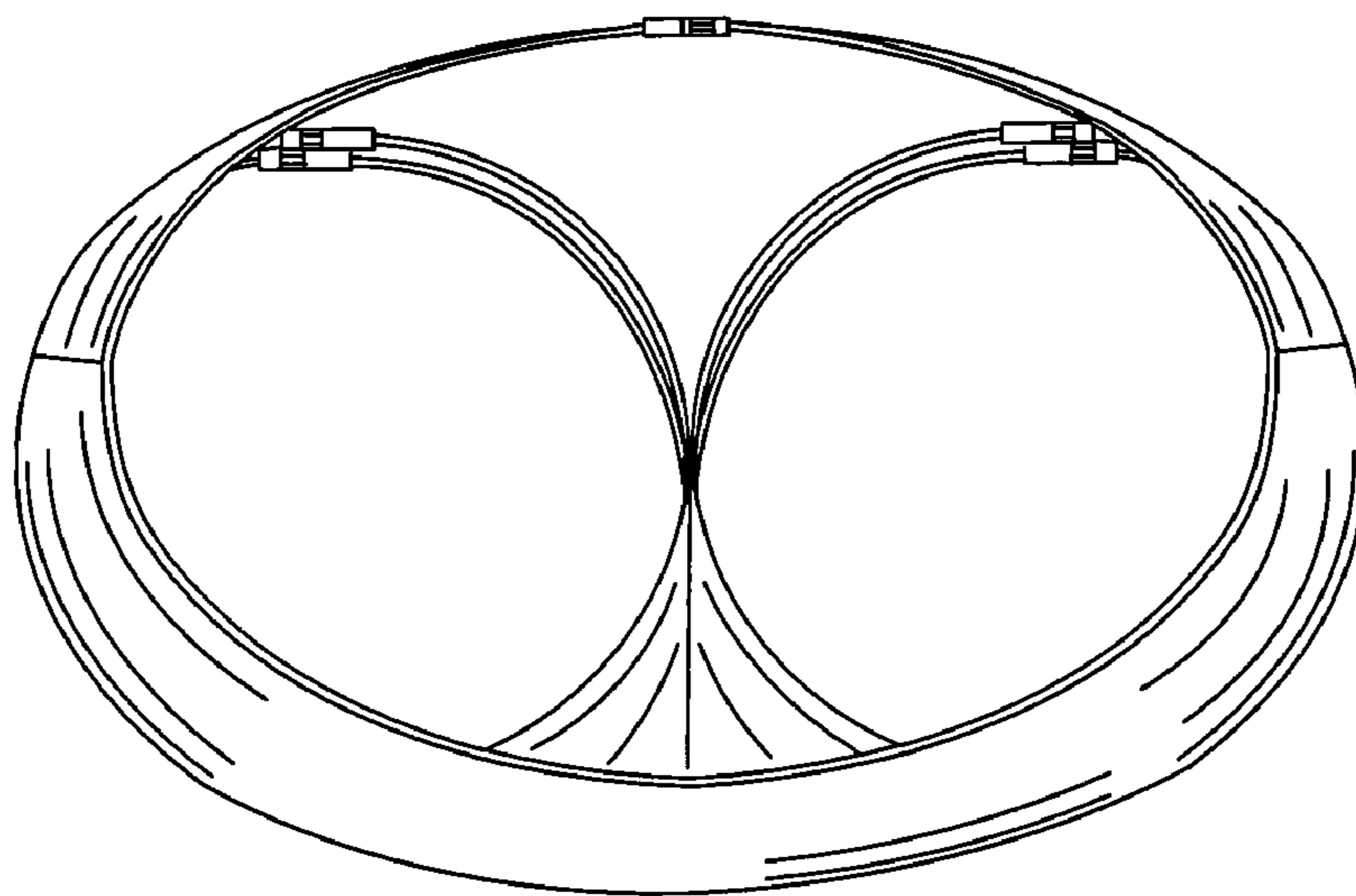

FIG. 5

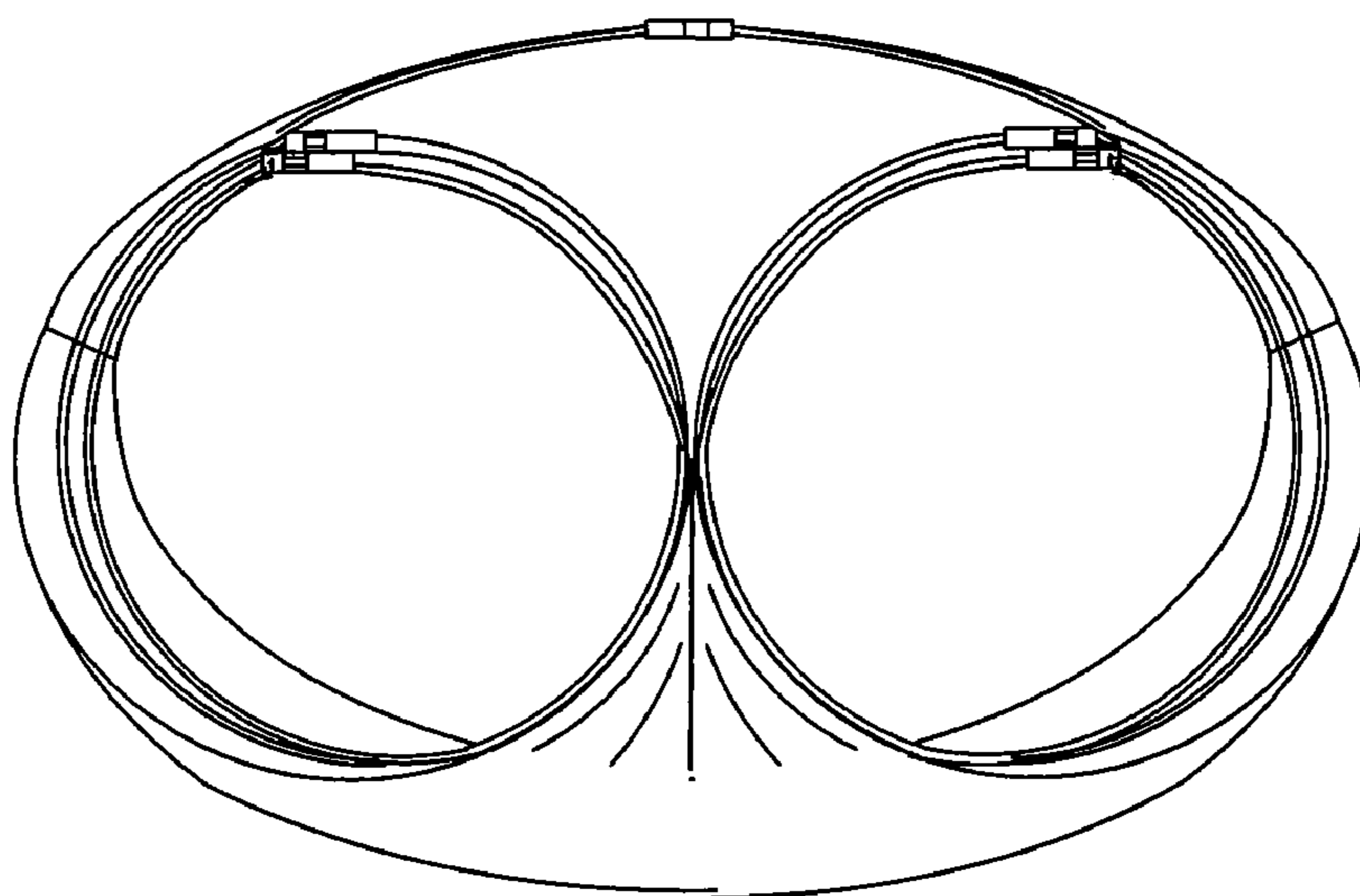

FIG. 6