



US00D584477S

(12) **United States Design Patent**  
**Caudill et al.**

(10) **Patent No.:** **US D584,477 S**  
(45) **Date of Patent:** **\*\* Jan. 13, 2009**

(54) **ANIMAL CHEW**

(75) Inventors: **Shellie Jean Porter Caudill**, Hamilton, OH (US); **John William Koenig**, Cincinnati, OH (US); **Craig Merillat Rasmussen**, Loveland, OH (US); **Susan Ruth Ward**, Oregonia, OH (US)

(73) Assignee: **The Iams Company**, Dayton, OH (US)

(\*\*) Term: **14 Years**

(21) Appl. No.: **29/297,973**

(22) Filed: **Nov. 26, 2007**

(51) **LOC (9) Cl.** ..... **01-01**

(52) **U.S. Cl.** ..... **D1/125; D30/160; D4/104; D4/136**

(58) **Field of Classification Search** ..... D30/158, D30/160; D1/100, 104, 106, 125-128, 199; D4/104, 136; D24/211-212; 119/702, 706-711  
See application file for complete search history.

(56) **References Cited**

**U.S. PATENT DOCUMENTS**

4,109,649	A *	8/1978	Iyomasa	.....	D30/160
D317,083	S *	5/1991	Chou	.....	D4/136
D404,495	S *	1/1999	Chien	.....	D24/211
D430,936	S *	9/2000	Noble	.....	D24/211
D472,642	S *	4/2003	Henckel	.....	D24/211
D499,226	S *	12/2004	Axelrod	.....	D1/106

D503,998	S *	4/2005	Axelrod	.....	D30/160
D528,736	S *	9/2006	Koenig et al.	.....	D1/125
D529,667	S *	10/2006	Axelrod	.....	D30/160
D530,481	S *	10/2006	Koenig et al.	.....	D1/125
D531,365	S *	10/2006	Axelrod	.....	D30/160
D539,430	S *	3/2007	Lowsky et al.	.....	D24/194
2007/0101946	A1 *	5/2007	Penny	.....	119/709
2008/0041320	A1 *	2/2008	Torney et al.	.....	119/709

\* cited by examiner

*Primary Examiner*—Cathy Anne MacCormac

(74) *Attorney, Agent, or Firm*—Kristin Kohler; SarahAnn Dressel; Roddy M. Bullock

(57) **CLAIM**

The ornamental design for an animal chew, as shown and described.

**DESCRIPTION**

FIG. 1 is a top perspective view showing our new design;

FIG. 2 is bottom perspective view thereof;

FIG. 3 is a bottom plan view thereof;

FIG. 4 is a top plan view thereof;

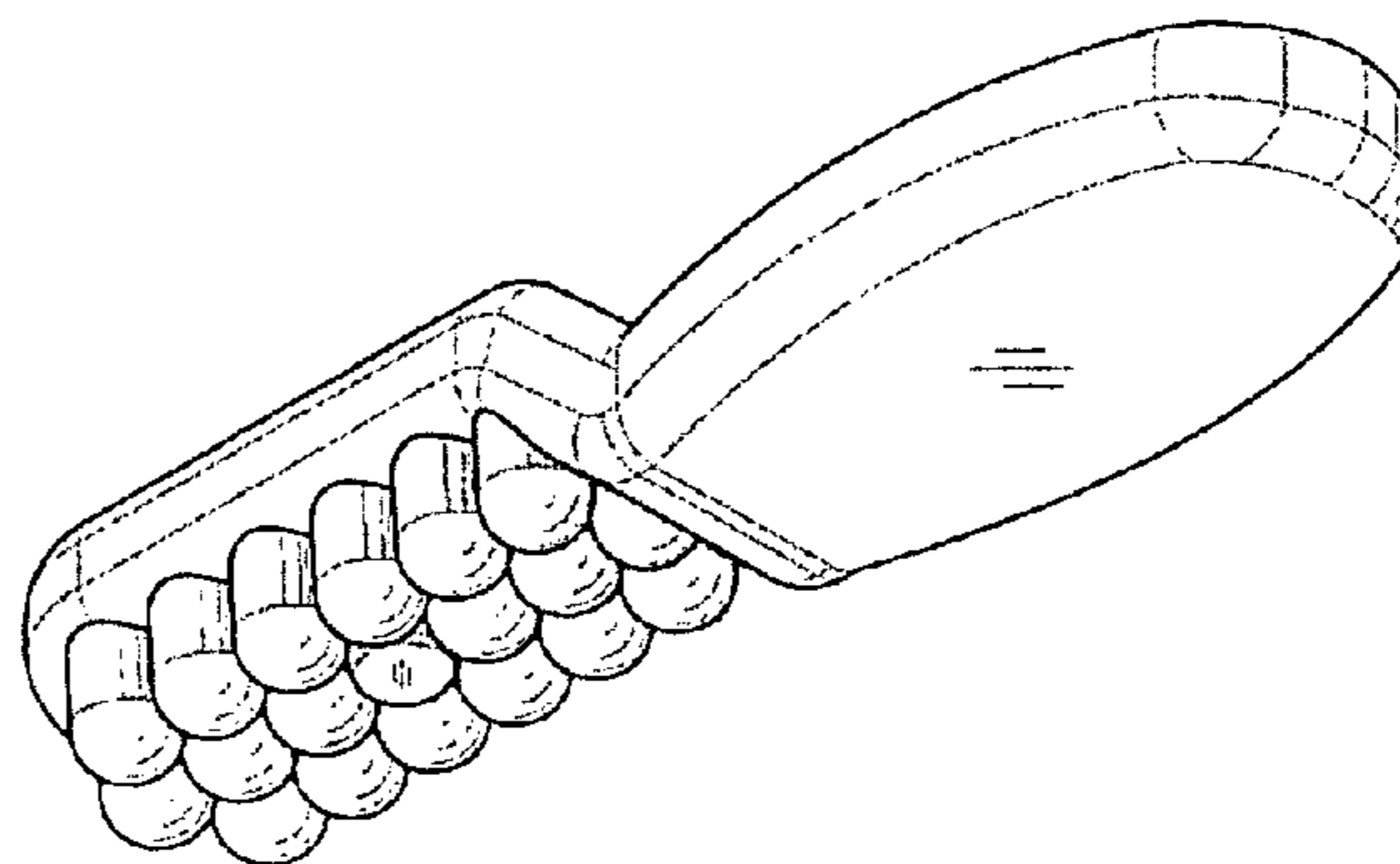
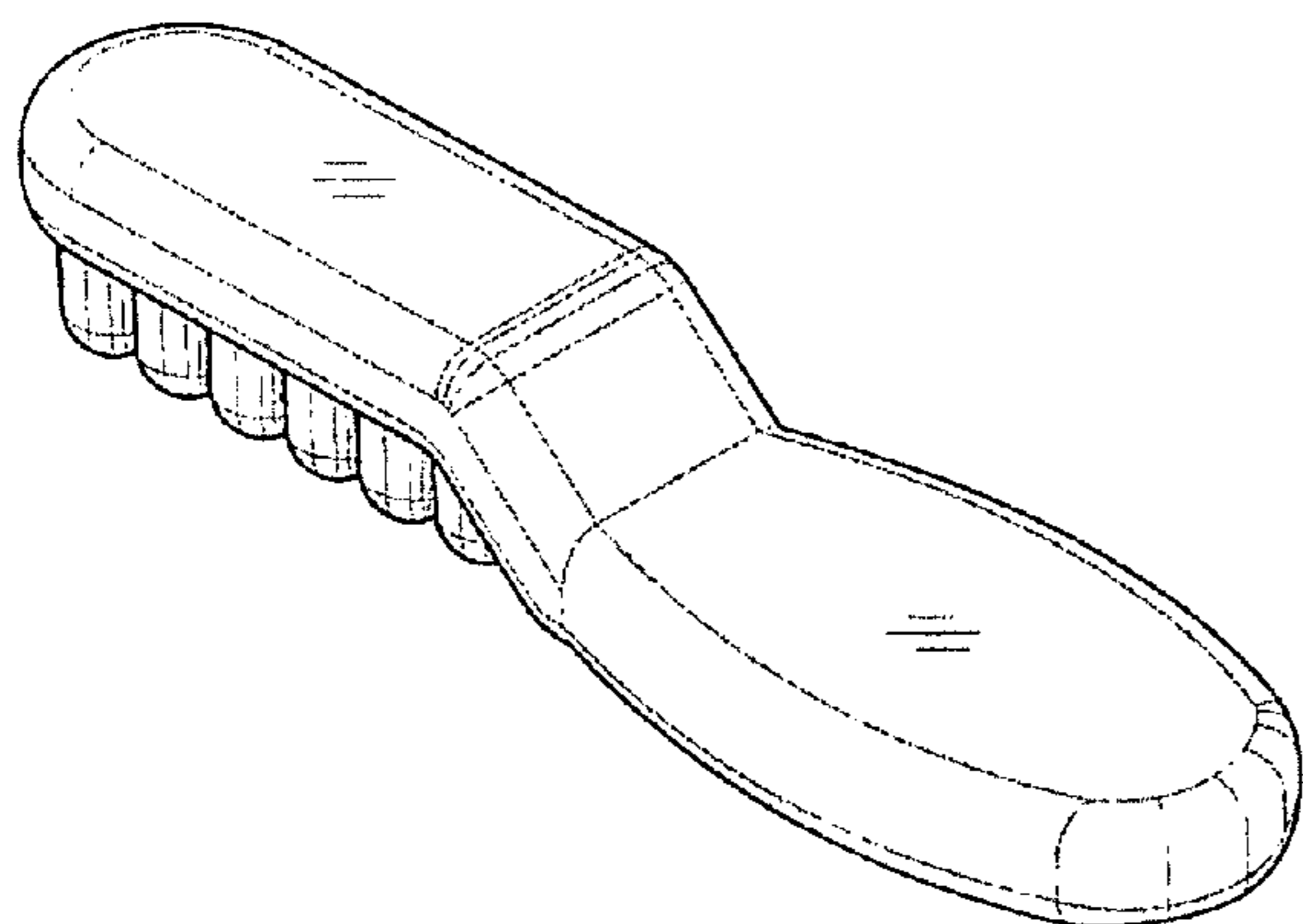
FIG. 5 is a left side view thereof;

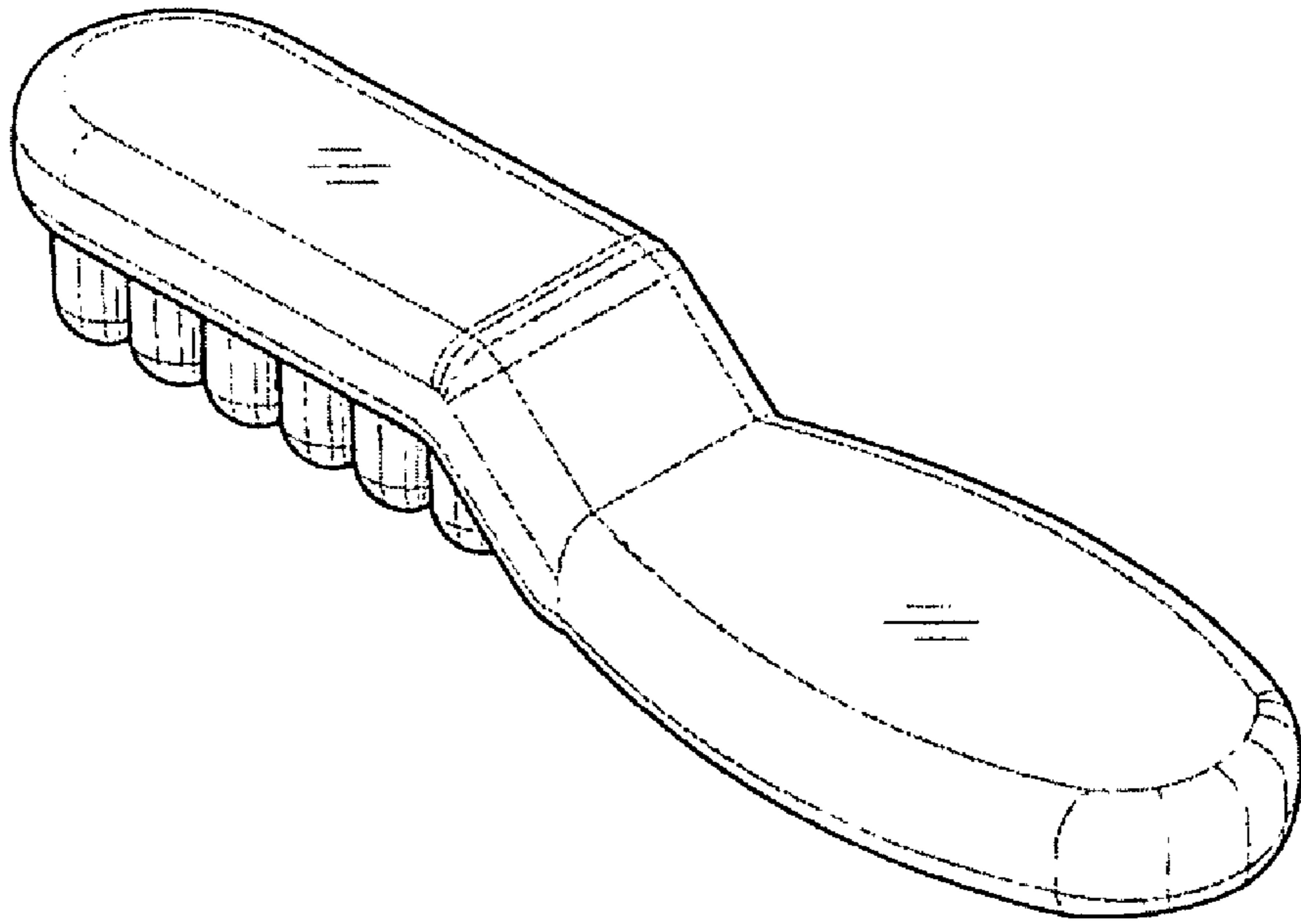
FIG. 6 is a right side view thereof;

FIG. 7 is a front view thereof; and,

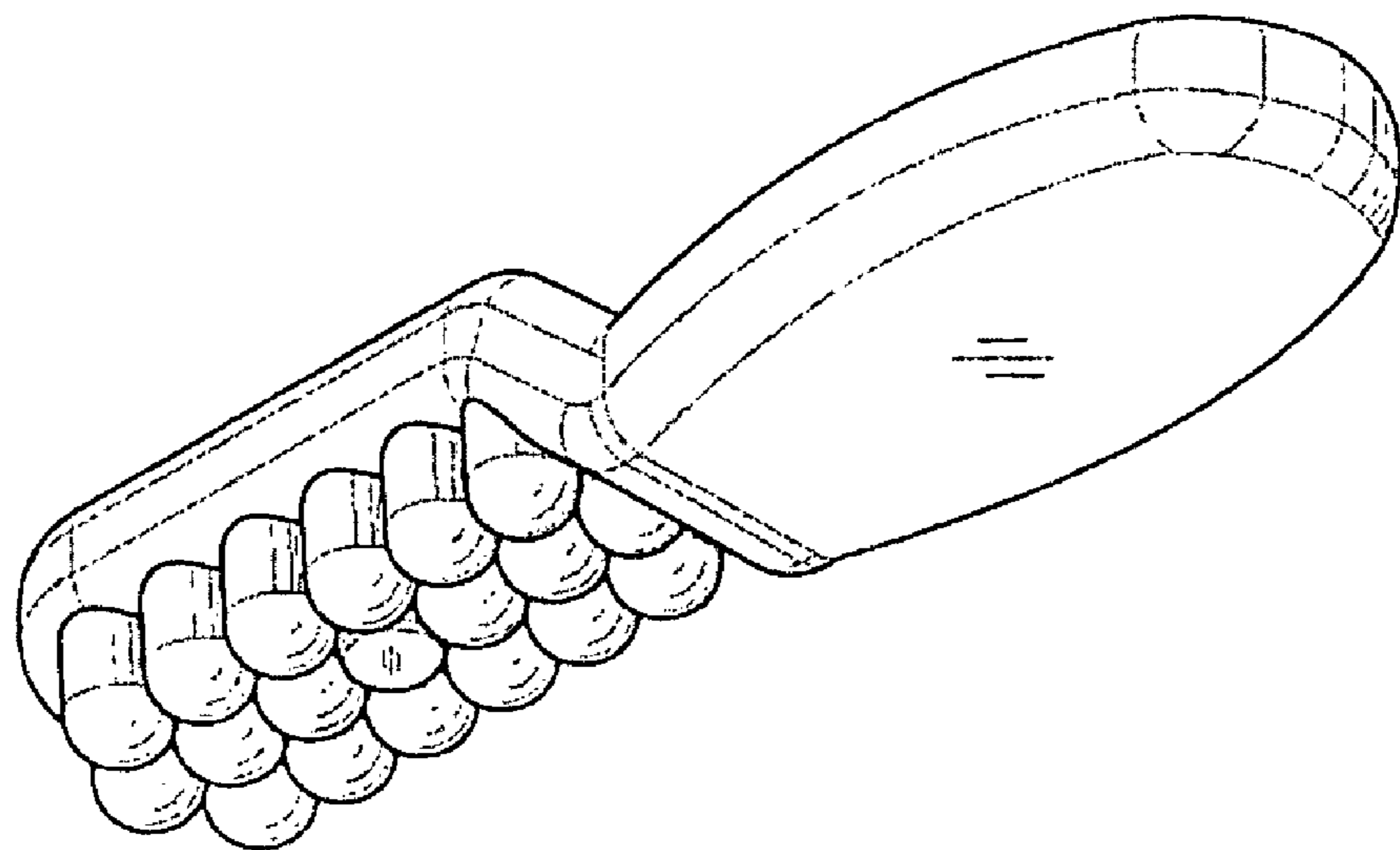
FIG. 8 is a rear view thereof.

**1 Claim, 4 Drawing Sheets**

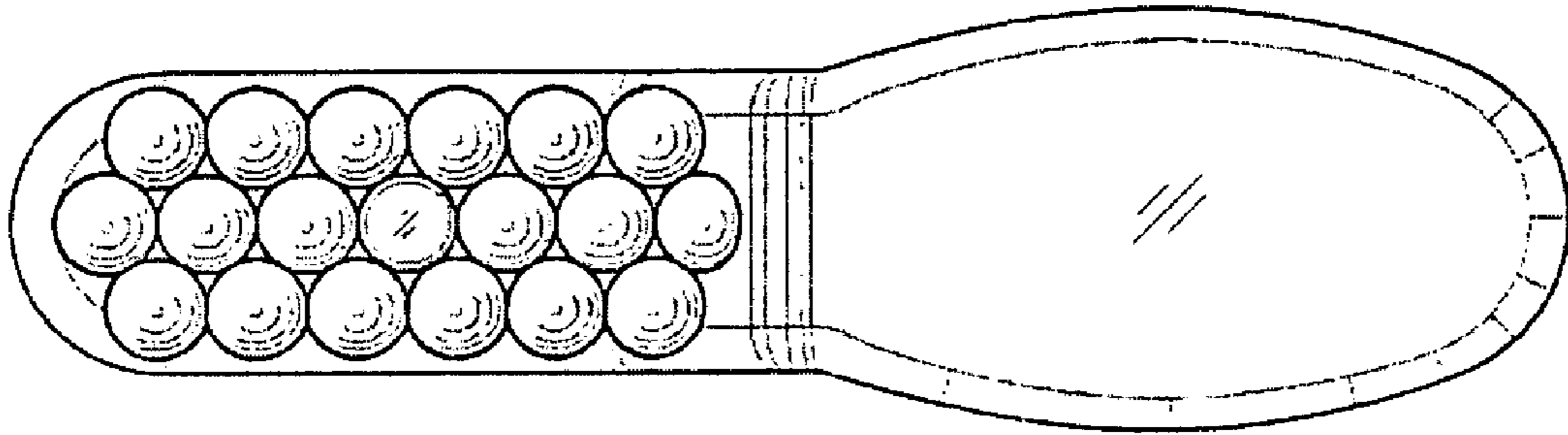




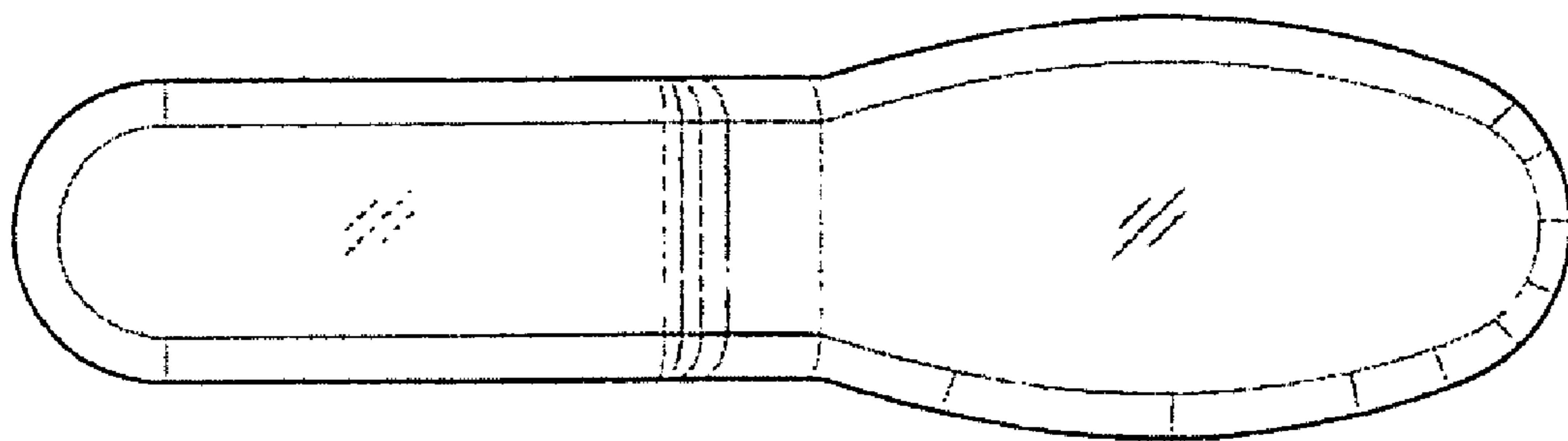
**Fig. 1**



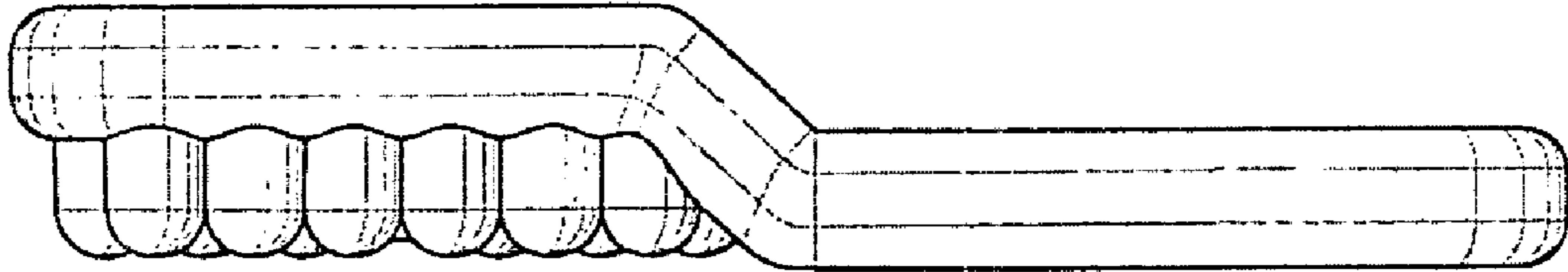
**Fig. 2**



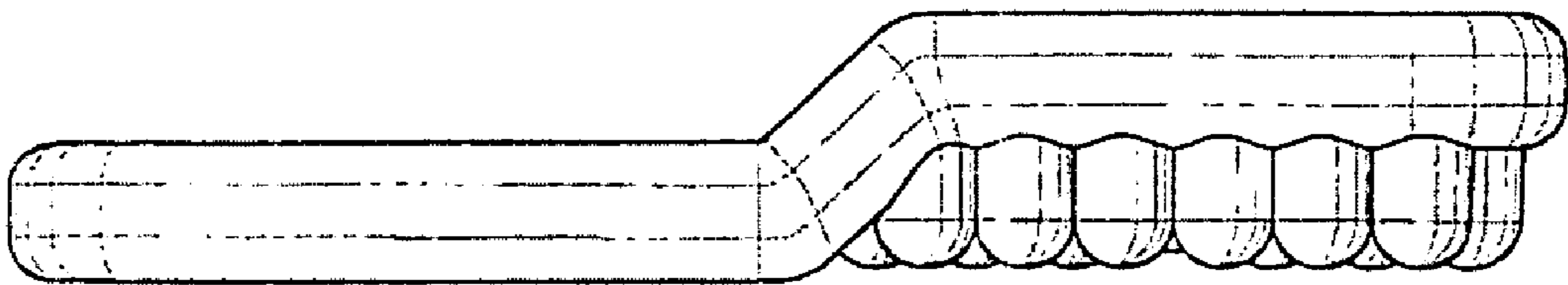
**Fig. 3**



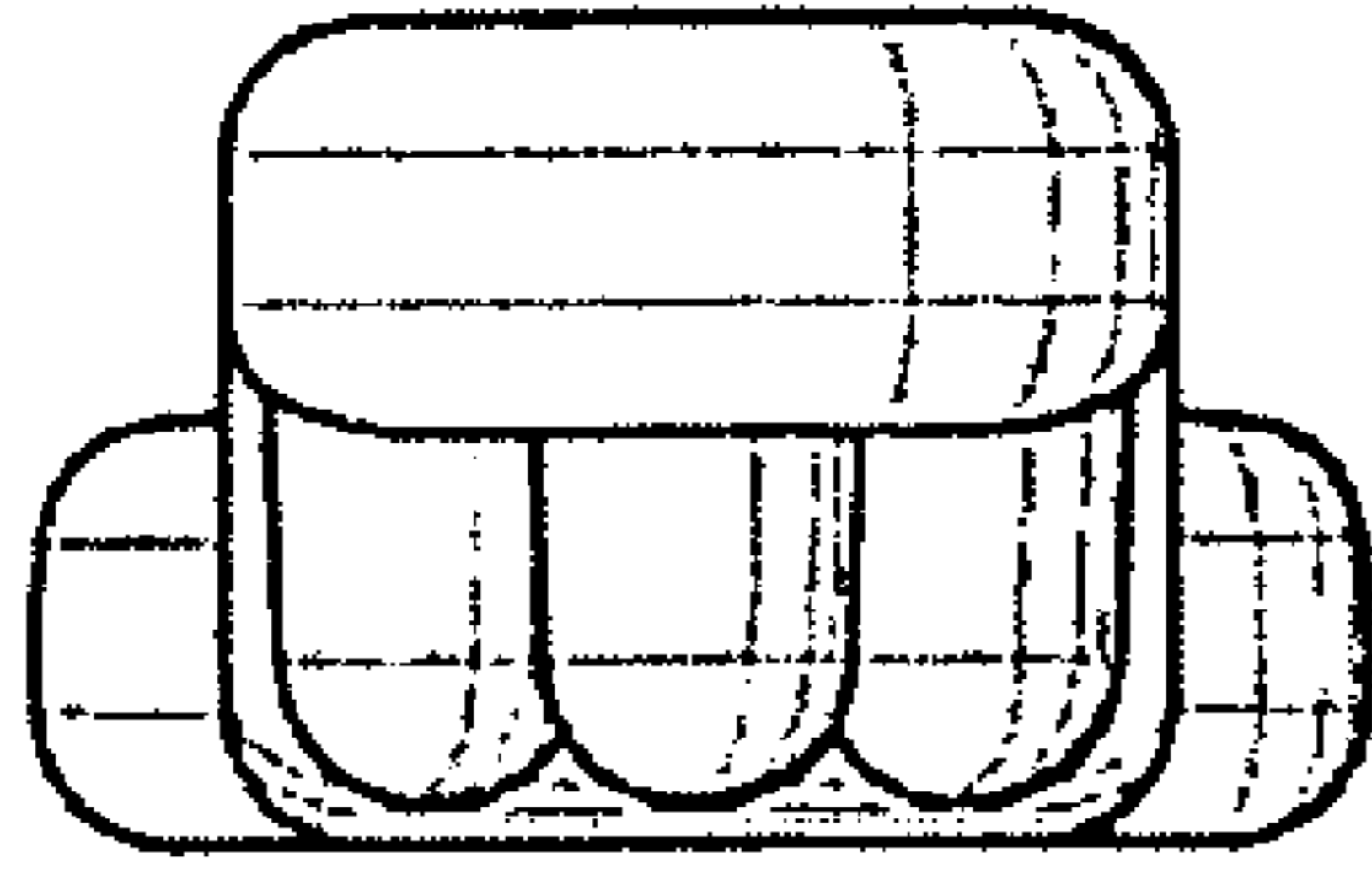
**Fig. 4**



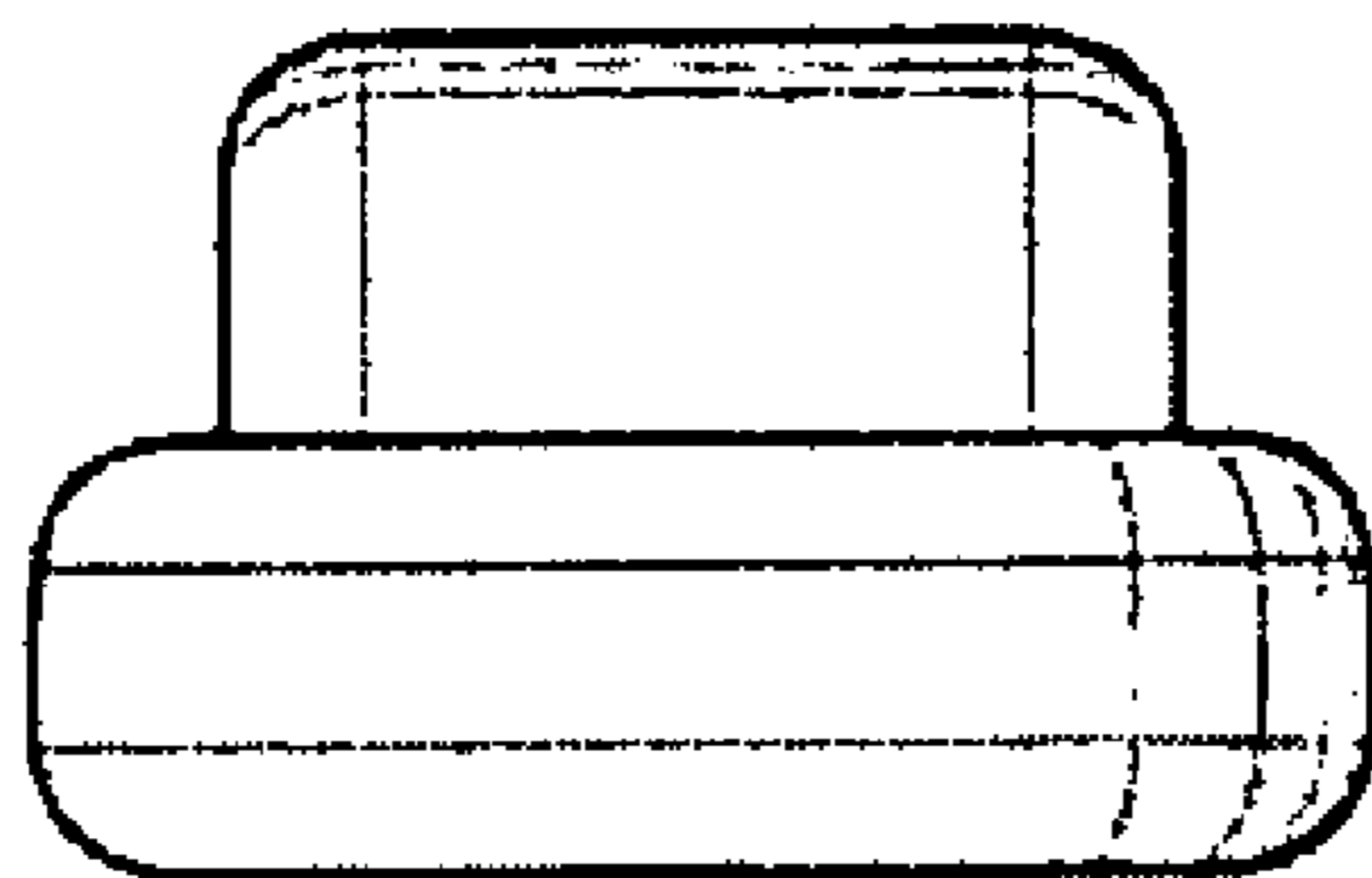
**Fig. 5**



**Fig. 6**



**Fig. 7**



**Fig. 8**