



US00D584355S

(12) **United States Design Patent**
Hidaka et al.

(10) **Patent No.:** **US D584,355 S**
(45) **Date of Patent:** **** Jan. 6, 2009**

(54) **ELECTRONIC PEN**
(75) Inventors: **Masataka Hidaka**, Kadoma (JP);
Yukinobu Kudo, Kadoma (JP); **Keiichi Okabe**, Kadoma (JP)
(73) Assignee: **Panasonic Corporation**, Osaka (JP)
(**) Term: **14 Years**
(21) Appl. No.: **29/297,394**
(22) Filed: **Nov. 9, 2007**
(51) **LOC (9) Cl.** **19-06**
(52) **U.S. Cl.** **D19/51**
(58) **Field of Classification Search** D8/8,
D8/61, 70; D14/411; D15/140; D19/35,
D19/36, 41, 42, 44, 45, 46, 43, 47, 48, 49,
D19/50, 51, 54, 55, 56, 57, 58; 24/11 R,
24/11 F, 11 P; 173/76, 77, 78, 79, 217; 401/55,
401/99, 100, 104, 105, 106, 107, 109, 196,
401/197, 202, 208, 209, 213, 192, 195, 243,
401/244, 245, 246, 247; 708/107
See application file for complete search history.

(56) **References Cited**
U.S. PATENT DOCUMENTS
2,334,271 A * 11/1943 Malm et al. 200/61.42
D173,326 S * 10/1954 Quackenbush D8/61
D200,732 S * 3/1965 Fischer D8/61
D223,987 S * 6/1972 Gamble D8/61
D255,834 S * 7/1980 Linden D24/152
D323,275 S * 1/1992 Sasaki et al. D8/61
D362,649 S * 9/1995 Rak et al. D14/411
5,673,996 A * 10/1997 Ducker 362/118
5,842,802 A * 12/1998 Lang et al. 401/68
D426,636 S * 6/2000 Herring D24/152
D434,629 S * 12/2000 Long D8/70
D436,511 S * 1/2001 Hayakawa et al. D8/68
D439,978 S * 4/2001 Ark et al. D24/140
D441,267 S * 5/2001 Heun D8/61
D444,363 S * 7/2001 Hayakawa et al. D8/61
6,257,351 B1 * 7/2001 Ark et al. 173/178

D461,697 S * 8/2002 Chunn et al. D8/70
D463,495 S * 9/2002 Sasada D19/66
D466,155 S * 11/2002 Brunetti D19/49
D472,443 S * 4/2003 Chunn et al. D8/70
D474,086 S * 5/2003 Heun D8/61
D494,034 S * 8/2004 Cheung D8/68
D497,388 S * 10/2004 Kit D19/36
D498,260 S * 11/2004 Burden et al. D19/51
D500,084 S * 12/2004 Hester et al. D19/66
6,837,638 B1 * 1/2005 Noguchi 401/110
D501,881 S 2/2005 Shimizu
D502,215 S * 2/2005 Hung D19/36
D508,528 S 8/2005 Shimizu
D517,885 S * 3/2006 Corcoran D8/68
D520,636 S * 5/2006 Hawley et al. D24/114
D522,580 S * 6/2006 Shibata D19/51
D550,772 S * 9/2007 Geddes D19/53
7,329,062 B2 * 2/2008 Brand et al. 401/108
2002/0148623 A1 * 10/2002 Pan 173/217
2003/0026642 A1 * 2/2003 Schwartzman 401/243

* cited by examiner
Primary Examiner—Elizabeth A Albert
Assistant Examiner—Karen E Eldridge Powers
(74) *Attorney, Agent, or Firm*—Brinks Hofer Gilson & Lione

(57) **CLAIM**
We claim the ornamental design for an electronic pen, as shown and described.

DESCRIPTION
FIG. 1 is a top perspective view of an electronic pen of the present invention;
FIG. 2 is a front view thereof;
FIG. 3 is a rear view thereof;
FIG. 4 is a first side view thereof;
FIG. 5 is a second side view thereof;
FIG. 6 is a top view thereof; and,
FIG. 7 is a bottom view thereof.

1 Claim, 7 Drawing Sheets

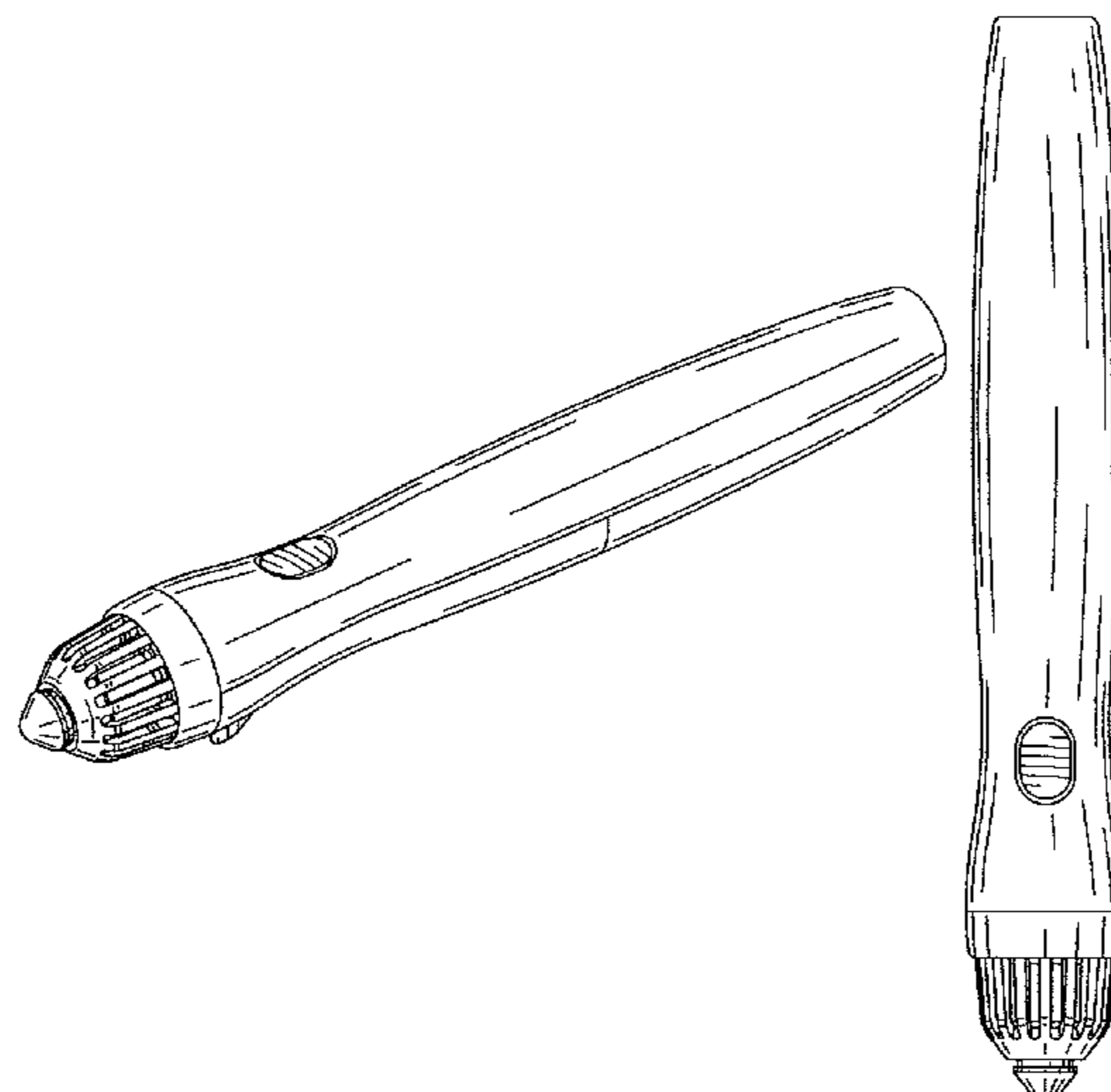

FIG. 1

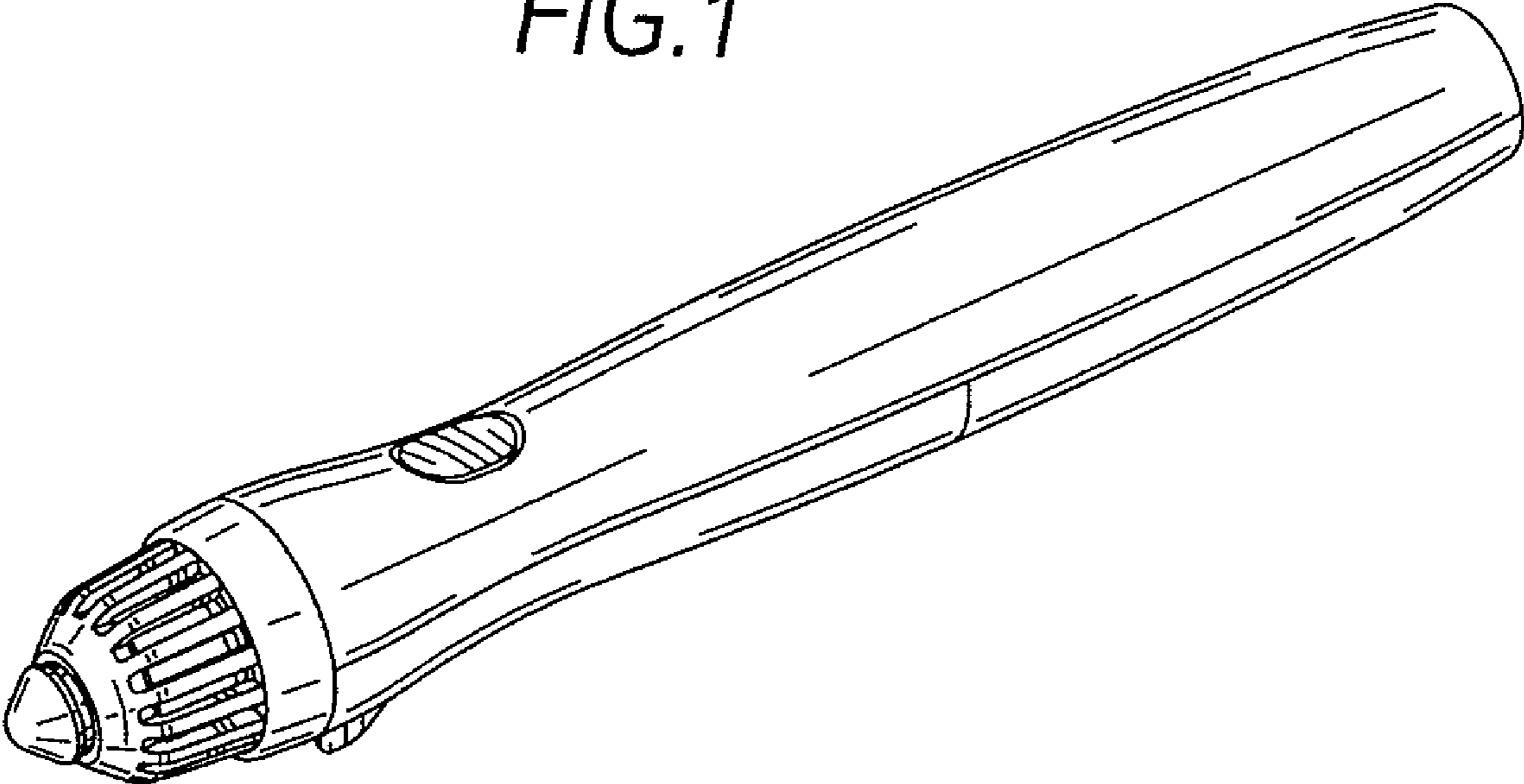

FIG. 2

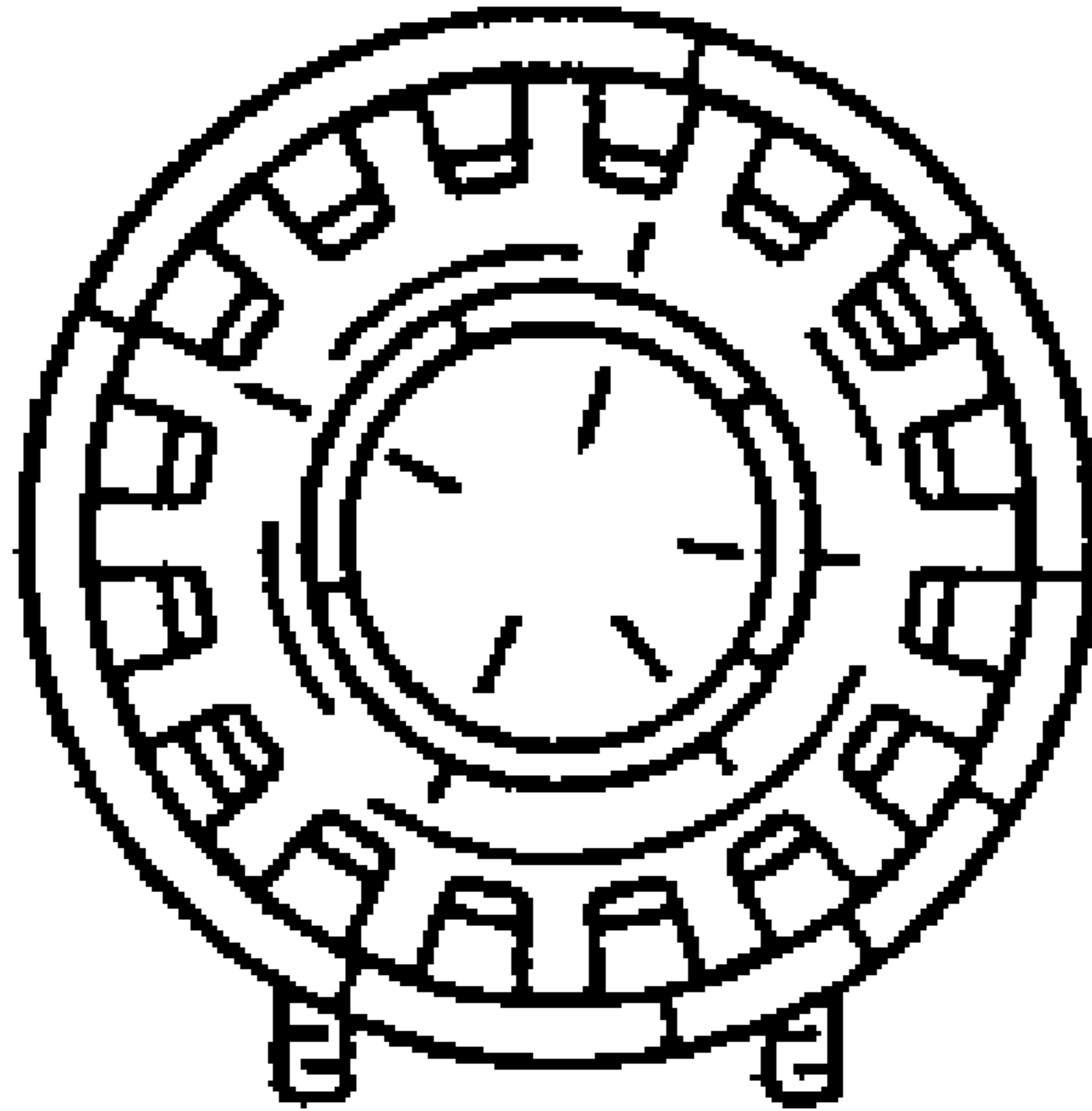

FIG. 3

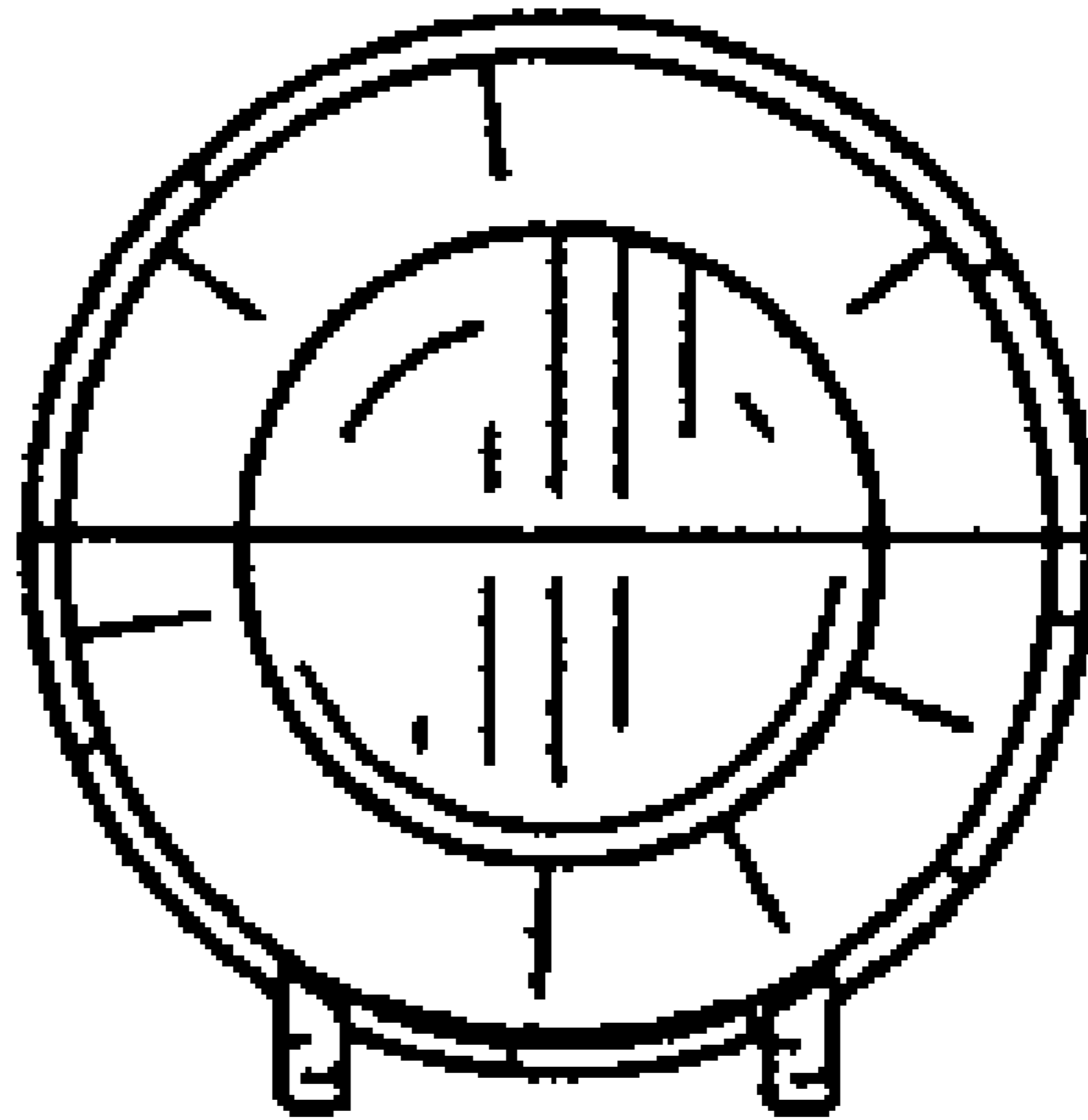

FIG. 4

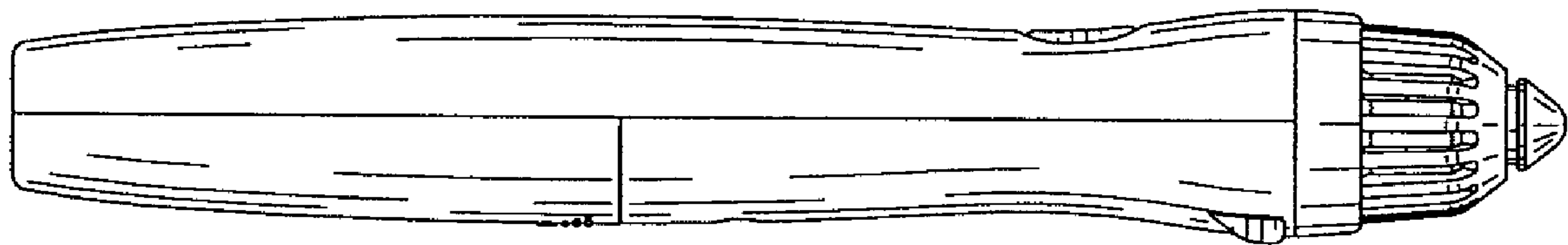

FIG. 5

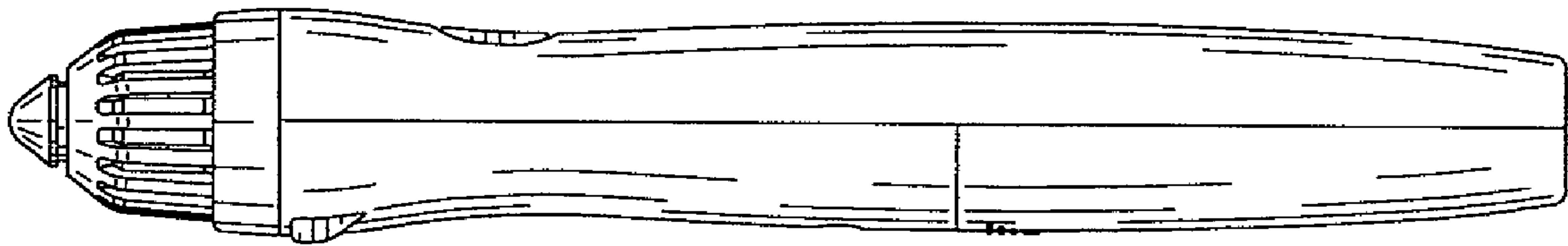

FIG. 6

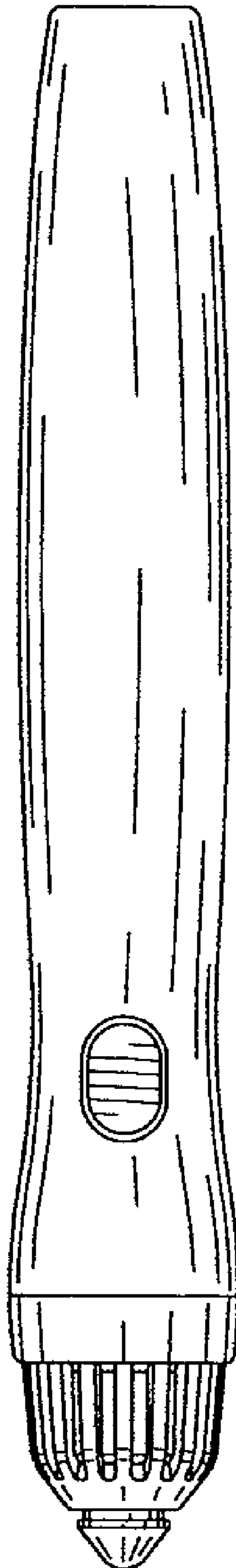

FIG. 7

