



US00D584350S

(12) **United States Design Patent**
Morino

(10) **Patent No.:** **US D584,350 S**
(45) **Date of Patent:** **** *Jan. 6, 2009**

(54) **INK POUCH OF AN INKJET PRINTER CARTRIDGE**

(75) Inventor: **Tetsu Morino**, Kanagawa (JP)

(73) Assignee: **Ricoh Company, Ltd.**, Tokyo (JP)

(**) Term: **14 Years**

(21) Appl. No.: **29/261,320**

(22) Filed: **Jun. 13, 2006**

(51) **LOC (9) Cl.** **18-02**

(52) **U.S. Cl.** **D18/56**

(58) **Field of Classification Search** D18/40,
D18/43, 56; 347/33, 49, 50, 85-87
See application file for complete search history.

(56) **References Cited**

U.S. PATENT DOCUMENTS

4,669,124	A *	5/1987	Kimura	383/80
D341,157	S *	11/1993	Kitahara et al.	D18/56
5,691,755	A *	11/1997	Pawlowski et al.	347/86
6,220,702	B1 *	4/2001	Nakamura et al.	347/86
D451,542	S *	12/2001	Ishizawa et al.	D18/56
6,848,775	B2 *	2/2005	Ishizawa et al.	347/86
D509,242	S *	9/2005	Muranaka	D18/56
D513,417	S *	1/2006	Ishizawa et al.	D18/56

D523,899	S *	6/2006	Holland et al.	D18/56
D544,909	S *	6/2007	Muranaka	D18/56
D546,876	S *	7/2007	Muranaka	D18/56
2004/0218021	A1 *	11/2004	Ishizawa et al.	347/85
2007/0176986	A1 *	8/2007	Tsuyuki et al.	347/85

* cited by examiner

Primary Examiner—Robert M Spear

Assistant Examiner—Anna K Dworzecka

(74) *Attorney, Agent, or Firm*—Dickstein Shapiro LLP

(57) **CLAIM**

The ornamental design for an ink pouch of an inkjet printer cartridge, as shown and described.

DESCRIPTION

FIG. 1 is a front elevation of an ink pouch of an inkjet printer cartridge according to the present invention;

FIG. 2 is a rear elevation thereof;

FIG. 3 is a top plan view thereof;

FIG. 4 is a bottom plan view thereof;

FIG. 5 is a right side elevation thereof;

FIG. 6 is a left side elevation thereof; and,

FIG. 7 is a top, front and left side perspective view thereof.

1 Claim, 4 Drawing Sheets

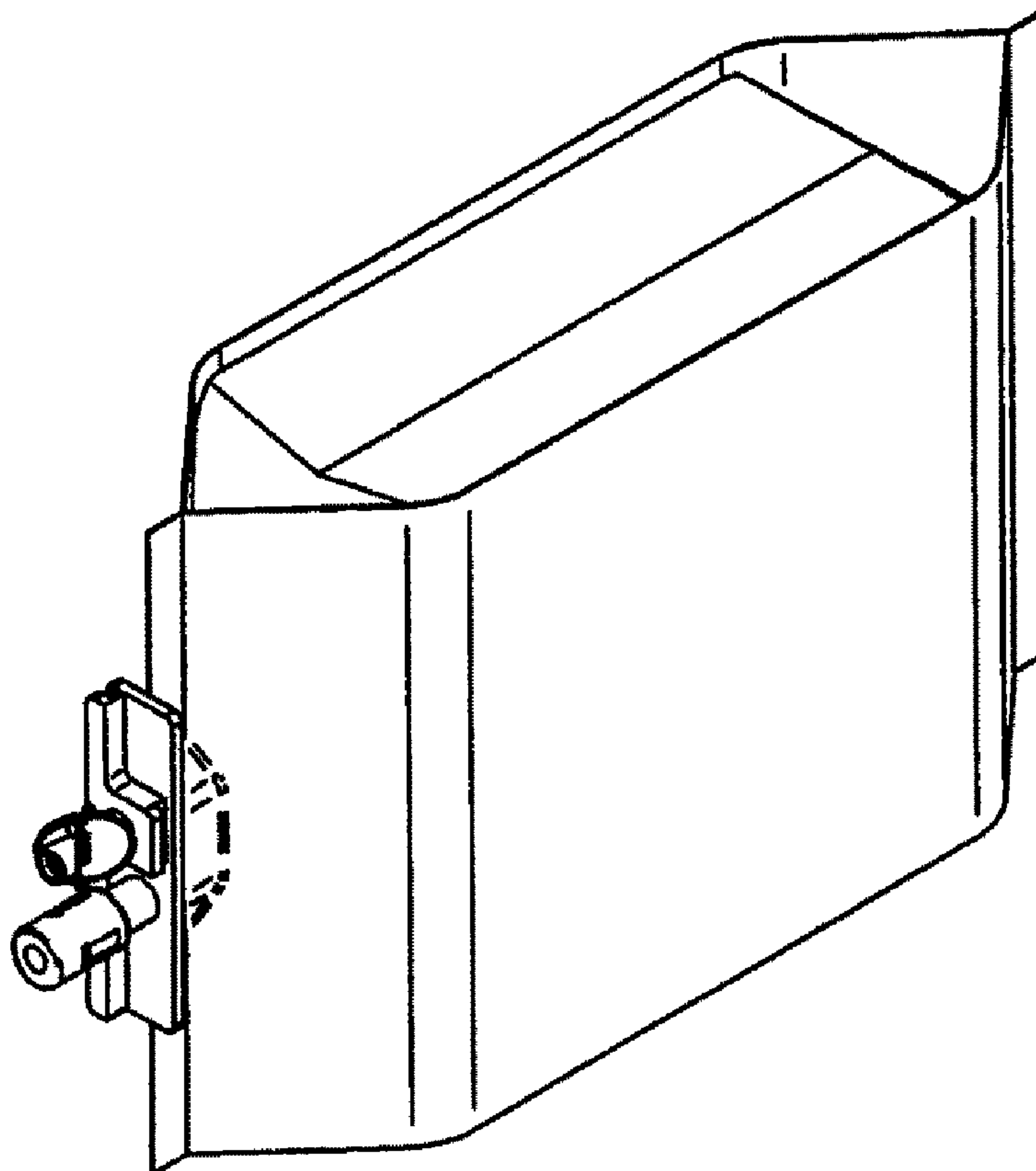

FIG. 1

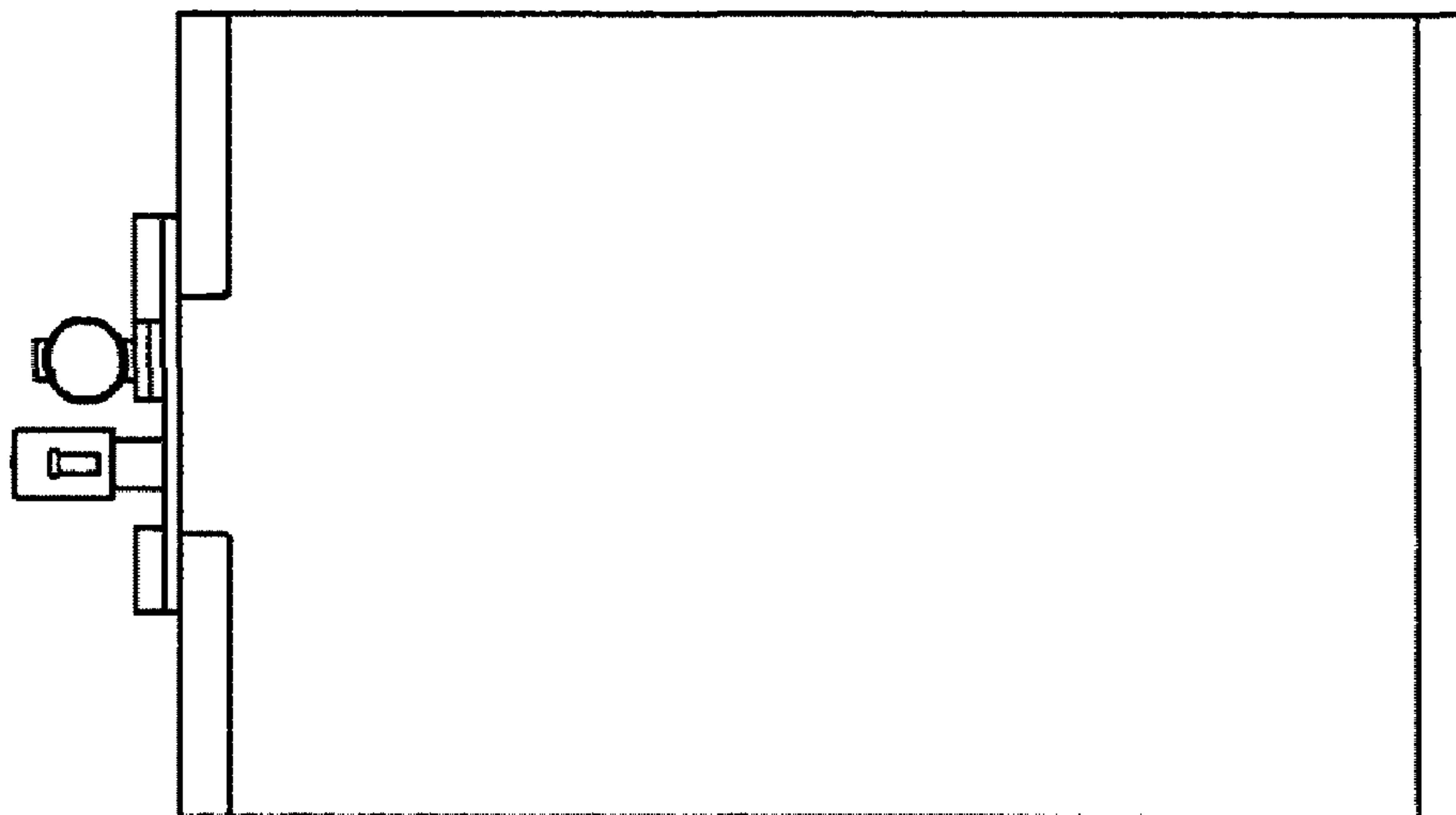

FIG. 2

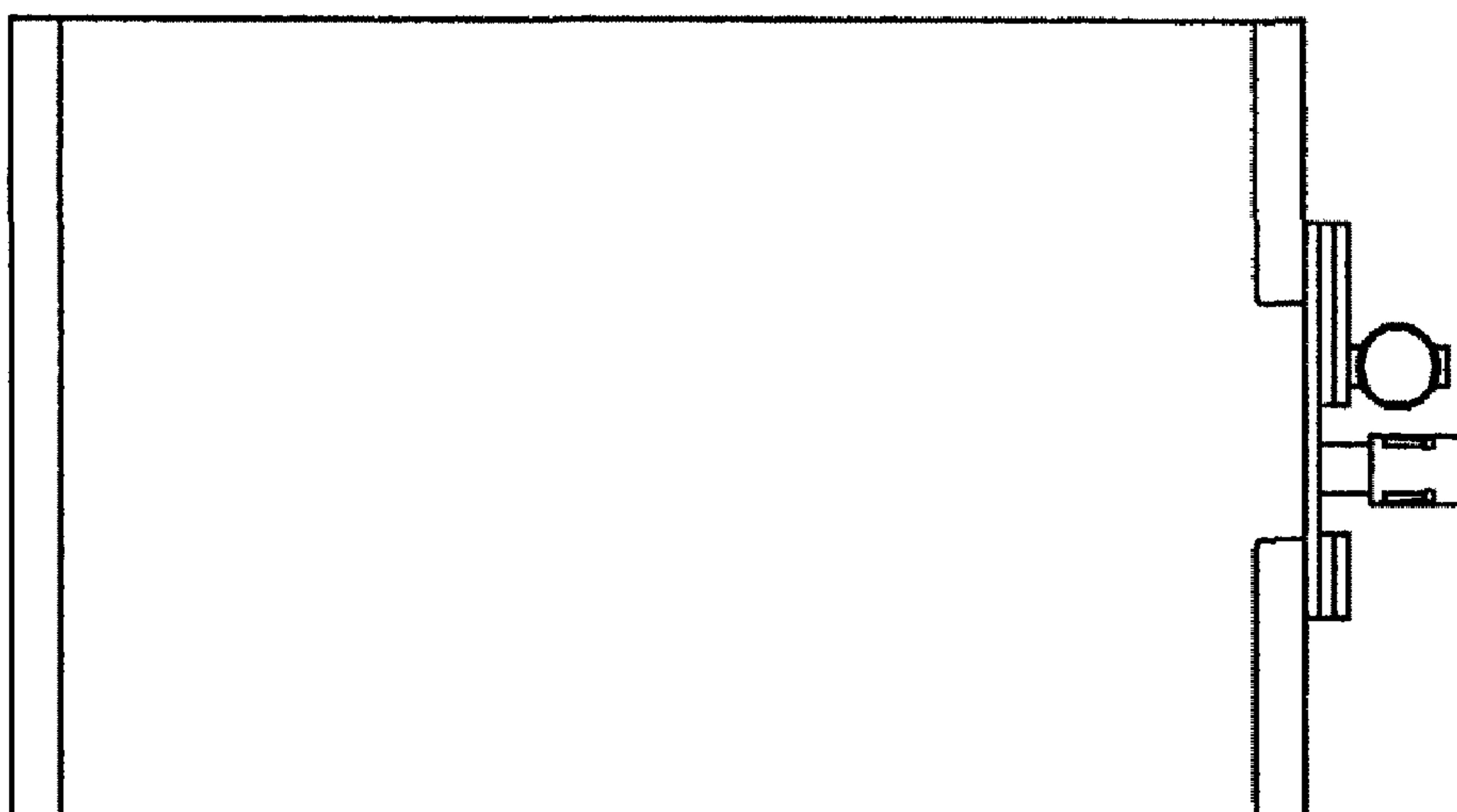

FIG. 3

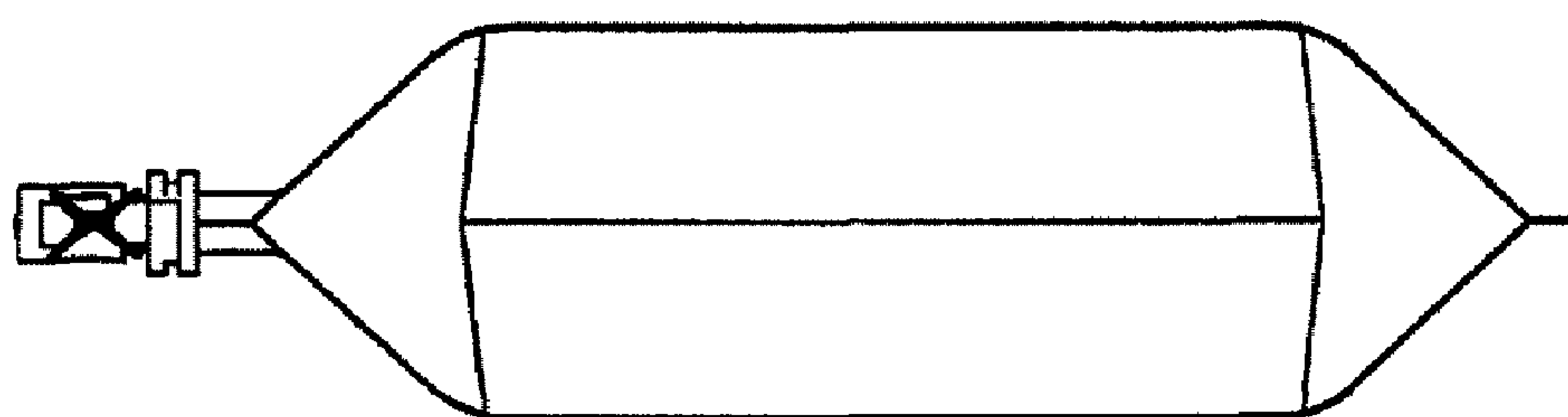

FIG. 4

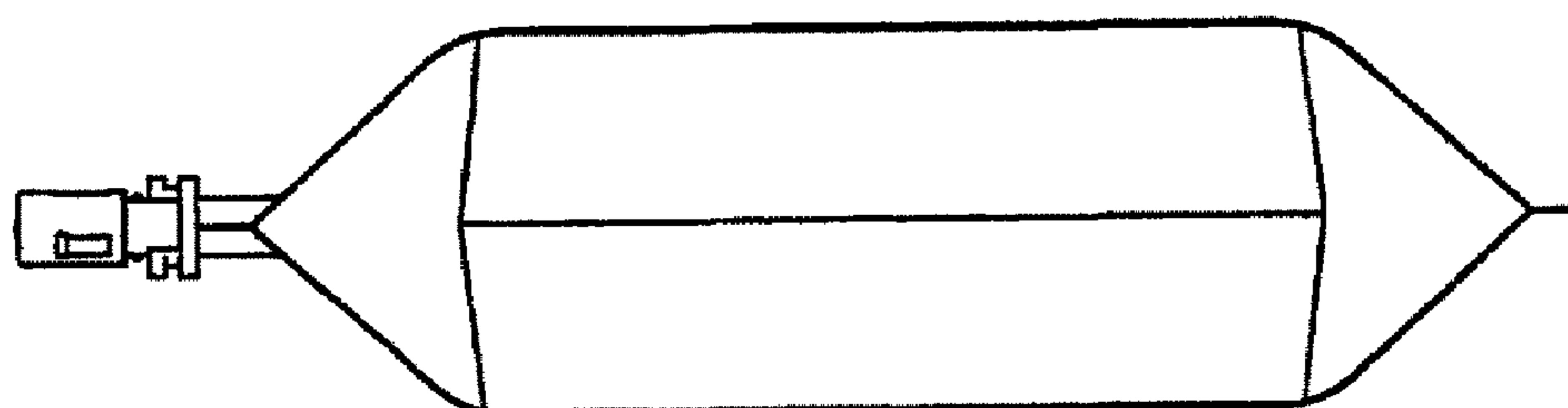

FIG. 5

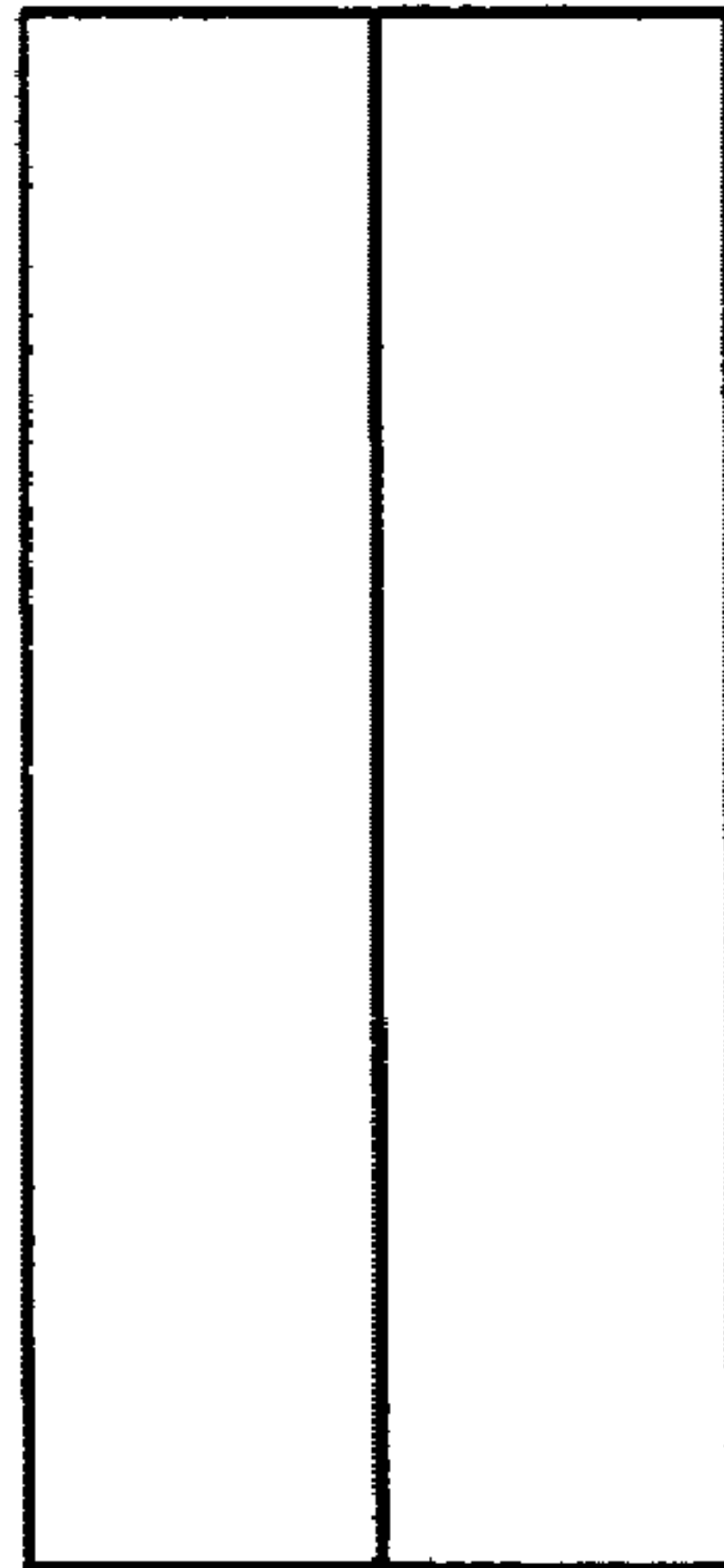

FIG. 6

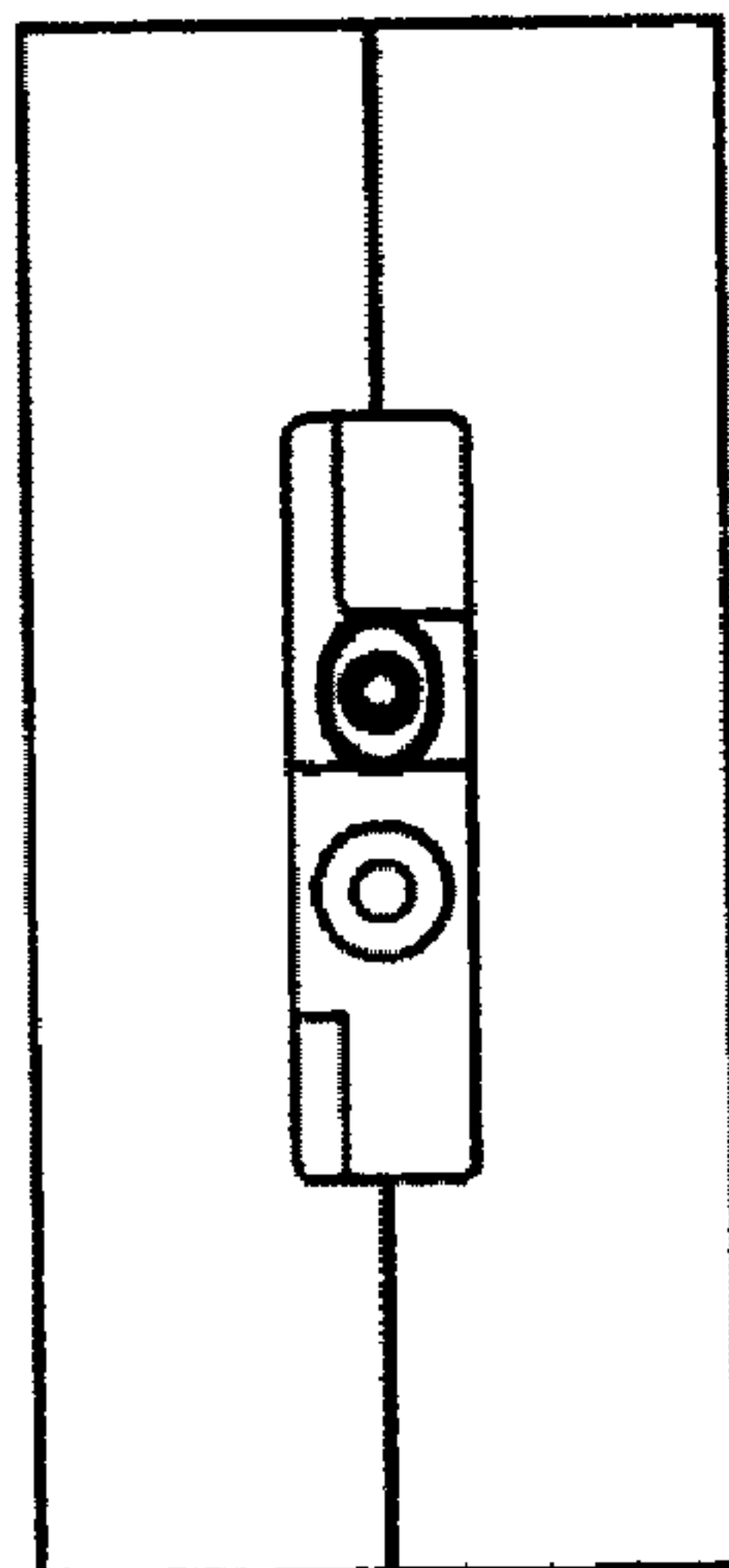

FIG. 7

