



US00D584277S

(12) **United States Design Patent**
Nishikawa

(10) **Patent No.:** **US D584,277 S**
(45) **Date of Patent:** **** Jan. 6, 2009**

(54) **MOBILE PHONE**

(75) Inventor: **Tadamichi Nishikawa**, Osaka (JP)

(73) Assignee: **Kyocera Corporation**, Kyoto (JP)

(**) Term: **14 Years**

(21) Appl. No.: **29/302,898**

(22) Filed: **Jan. 28, 2008**

(30) **Foreign Application Priority Data**

Nov. 15, 2007 (JP) 2007-031522

(51) **LOC (9) Cl.** **14-03**

(52) **U.S. Cl.** **D14/138 AB**

(58) **Field of Classification Search** D14/138,
D14/496, 341-347; 455/575.3, 575.1

See application file for complete search history.

(56) **References Cited**

U.S. PATENT DOCUMENTS

- D462,064 S * 8/2002 Kim D14/138 AB
- D496,014 S * 9/2004 Lodato et al. D14/138 AB
- D505,124 S * 5/2005 Takada D14/138 AB
- D524,787 S * 7/2006 Watanabe et al. D14/138 AB
- D536,686 S * 2/2007 Miyata D14/138 AB
- D537,428 S * 2/2007 Fahlgren D14/138 AB
- D546,795 S * 7/2007 Kim et al. D14/138 AB
- D549,199 S * 8/2007 Sugiura D14/138 AB
- D552,065 S * 10/2007 Kim et al. D14/138 AB
- D552,067 S * 10/2007 Han et al. D14/138 AB
- D553,110 S * 10/2007 Park et al. D14/138 AB
- D553,126 S * 10/2007 Katayama D14/138 AB
- D555,614 S * 11/2007 Holmung et al. D14/138 AB
- D557,232 S * 12/2007 Lee D14/138 AB
- D560,184 S * 1/2008 Hunt et al. D14/138 AB
- D560,643 S * 1/2008 Kim et al. D14/138 AB
- D565,531 S * 4/2008 Park et al. D14/138 AB
- D566,092 S * 4/2008 Nishikawa D14/138 AB
- D567,209 S * 4/2008 Moss et al. D14/138 AB
- D568,859 S * 5/2008 Choi D14/138 AB
- D568,860 S * 5/2008 Kang D14/138 AB
- D572,223 S * 7/2008 Lim D14/138

- D572,224 S * 7/2008 Kim et al. D14/138
- D572,226 S * 7/2008 Park et al. D14/138
- D573,968 S * 7/2008 Chen et al. D14/138
- D575,754 S * 8/2008 Lee D14/138

OTHER PUBLICATIONS

Nokia 2760 telephone, announced May 2007, [online], [site visited Sep. 23, 2008]. Available from Internet ,<URL: <http://www.gsmarena.com>>.*

Alcatel OT-C707 telephone, announced Feb. 2007, [online], [site visited Sep. 23, 2008]. Available from Internet ,<URL: <http://www.gsmarena.com>>.*

BenQ-Siemens EF81 telephone, announced Jan. 2006, [online], [site visited Sep. 23, 2008]. Available from Internet ,<URL: <http://www.gsmarena.com>>.*

Sanyo Katana Eclipse telephone, announced Aug. 18, 2008, [online], [site visited Sep. 30, 2008]. Available from Internet ,<URL: http://www.phonearena.com/htmls/Sanyo-Katana-Eclipse-phone-pb_3030.html>.*

* cited by examiner

Primary Examiner—Jeffrey D Asch

(74) *Attorney, Agent, or Firm*—Darby & Darby

(57) **CLAIM**

The ornamental design for mobile phone, as shown and described.

DESCRIPTION

FIG. 1 is a front, right-side perspective view with the lid open of my new design for mobile phone;

FIG. 2 is a front, bottom, right-side perspective view thereof with the lid closed;

FIG. 3 is a front elevation view thereof;

FIG. 4 is a rear elevation view thereof;

FIG. 5 is a top plan view thereof;

FIG. 6 is a bottom plan view thereof;

FIG. 7 is a left-side elevation view thereof; and,

FIG. 8 is a right-side elevation view thereof.

1 Claim, 2 Drawing Sheets

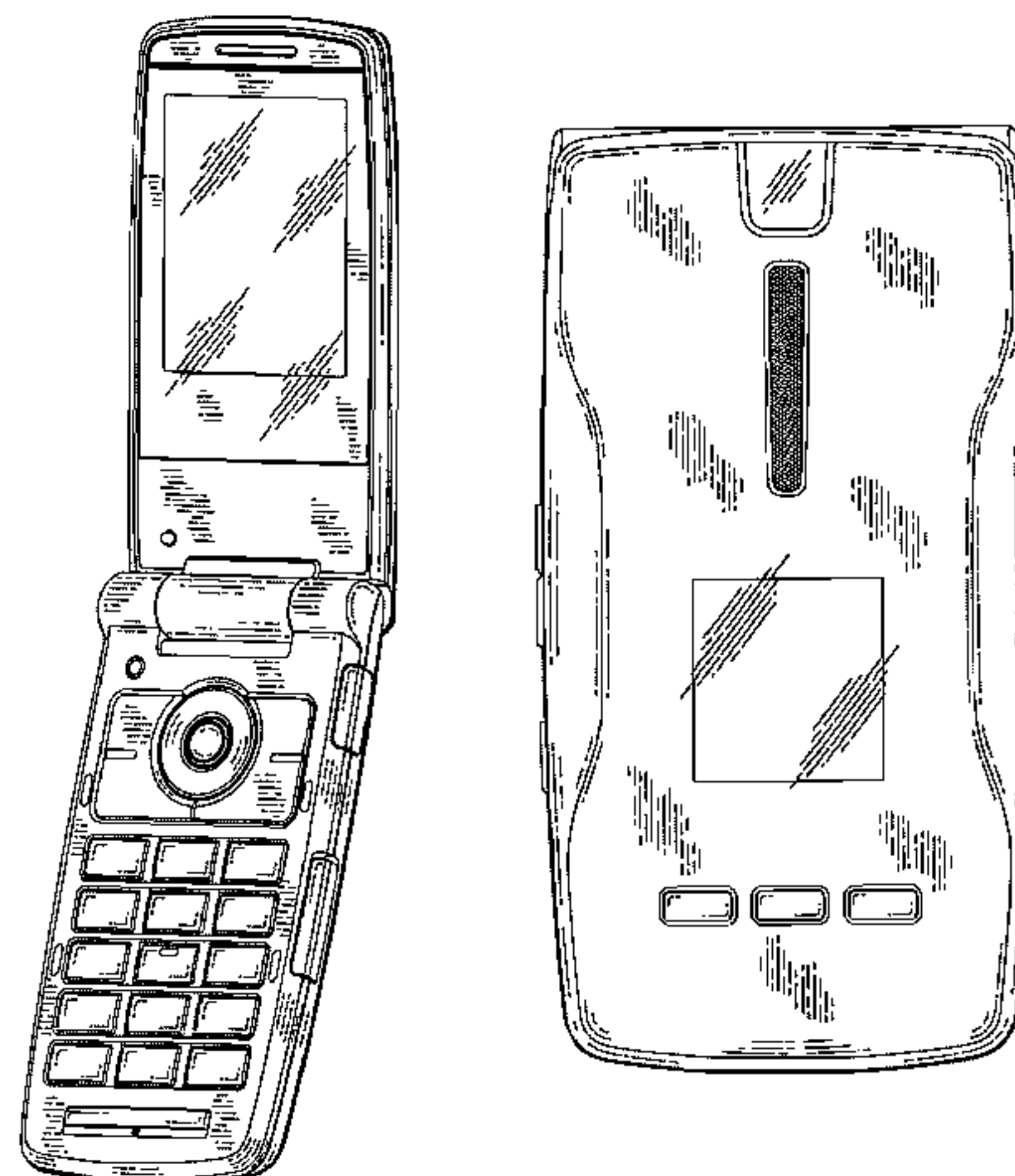

FIG. 4

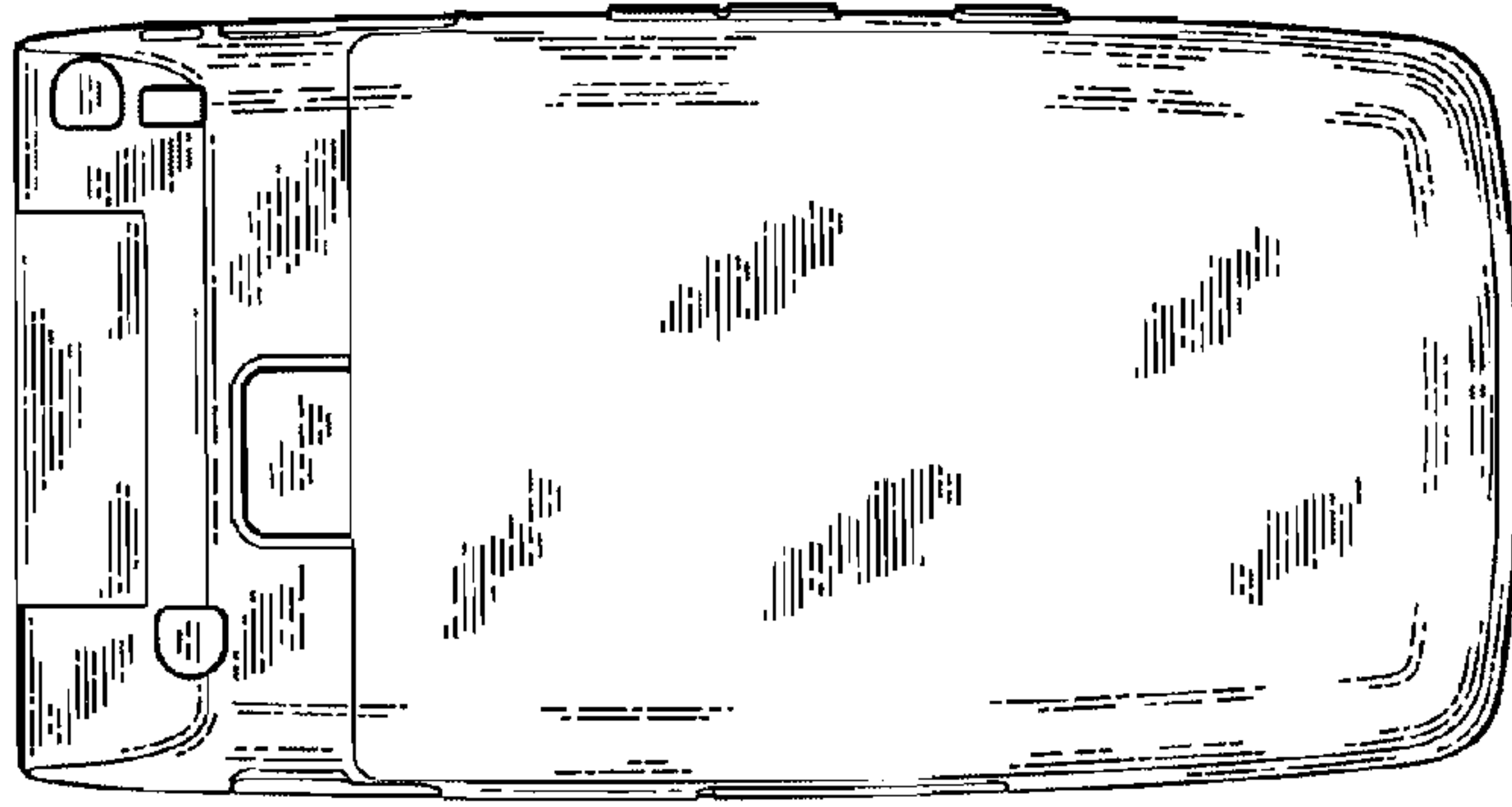

FIG. 3

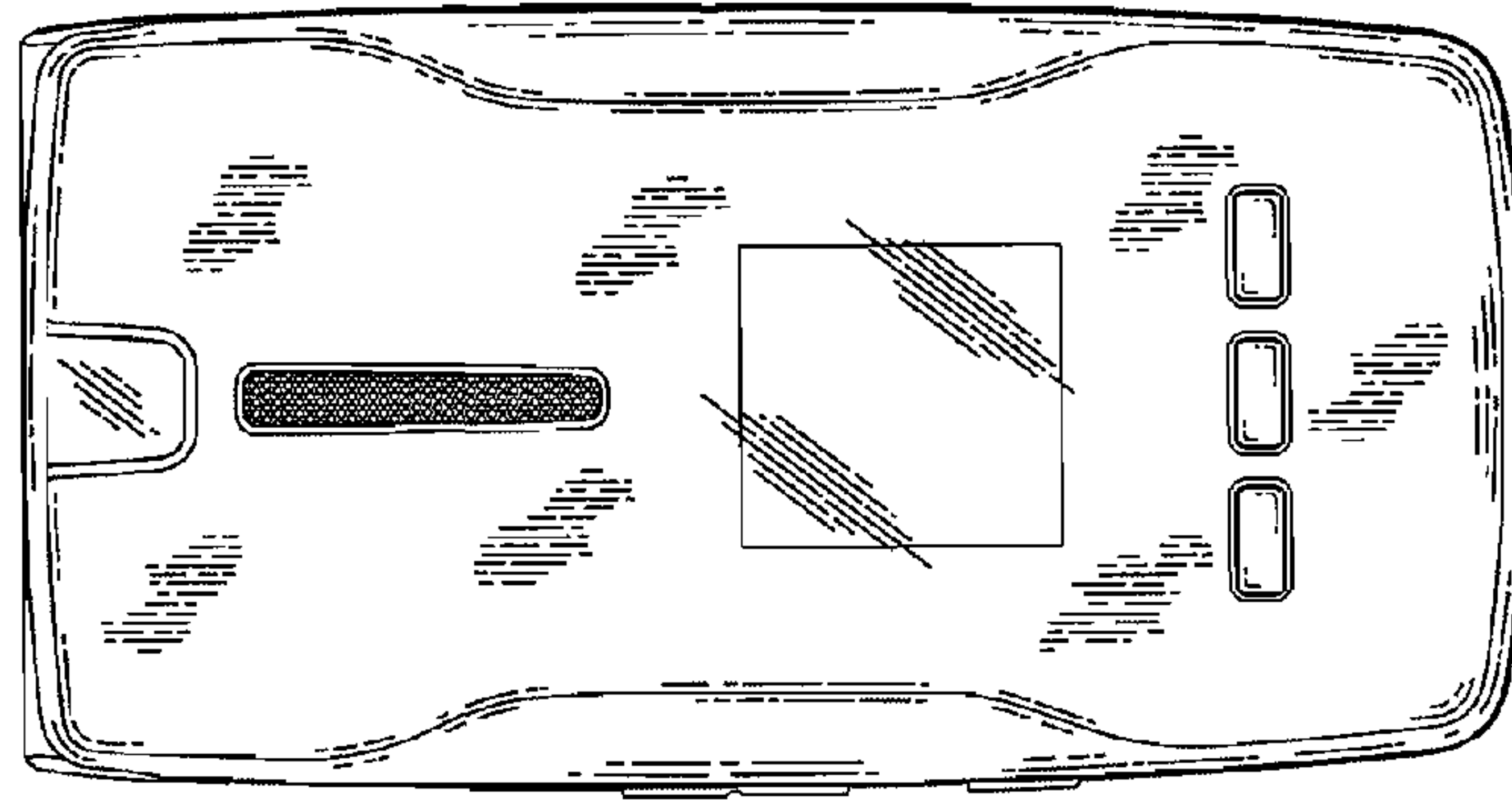

FIG. 2

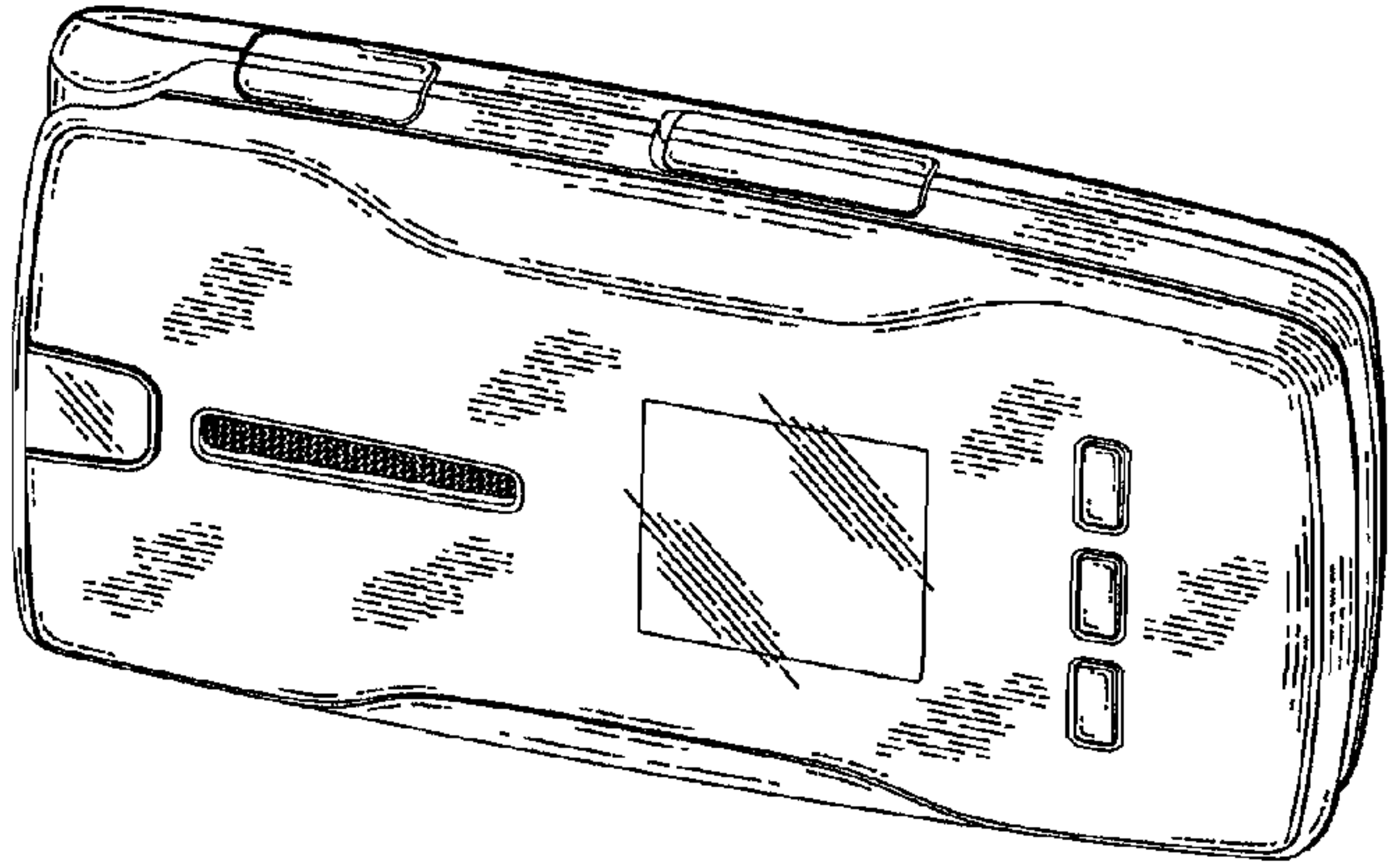

FIG. 1

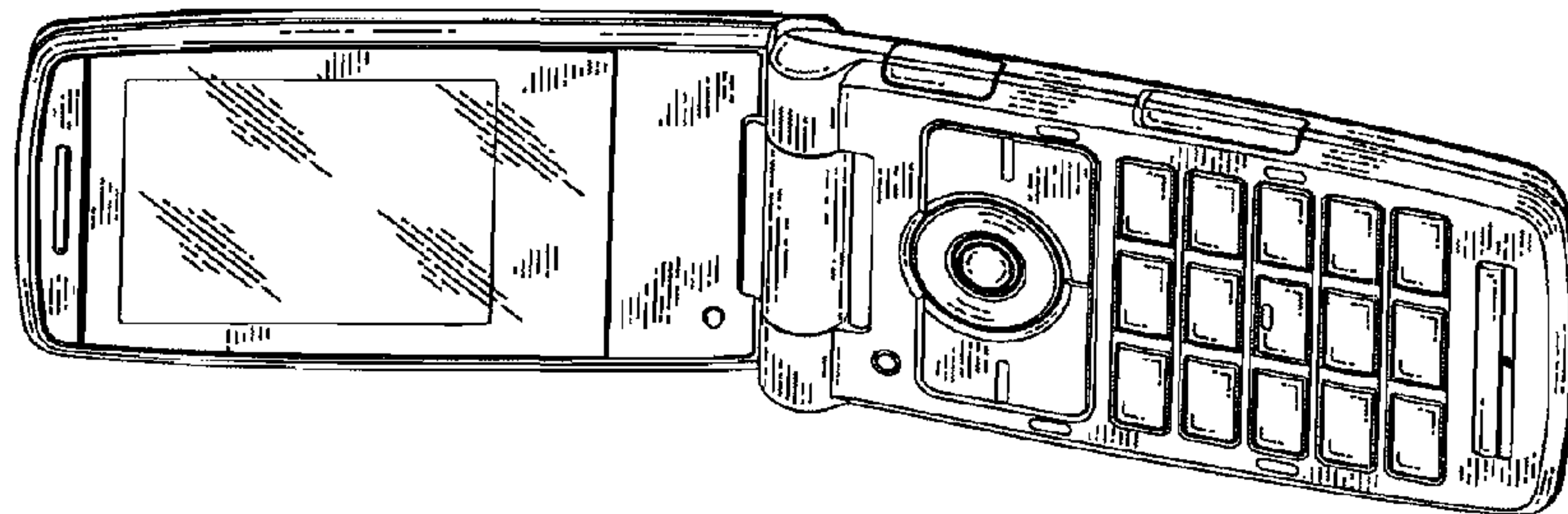

FIG. 8

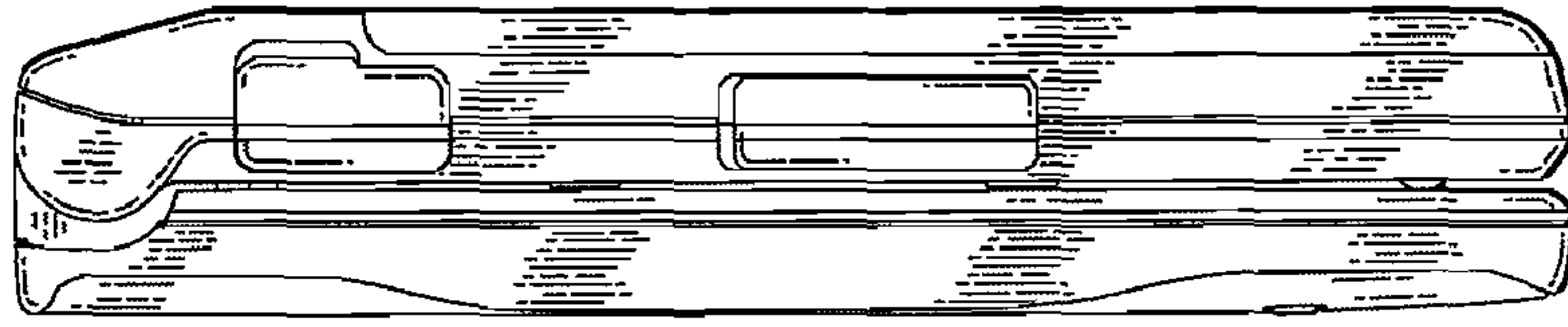

FIG. 7

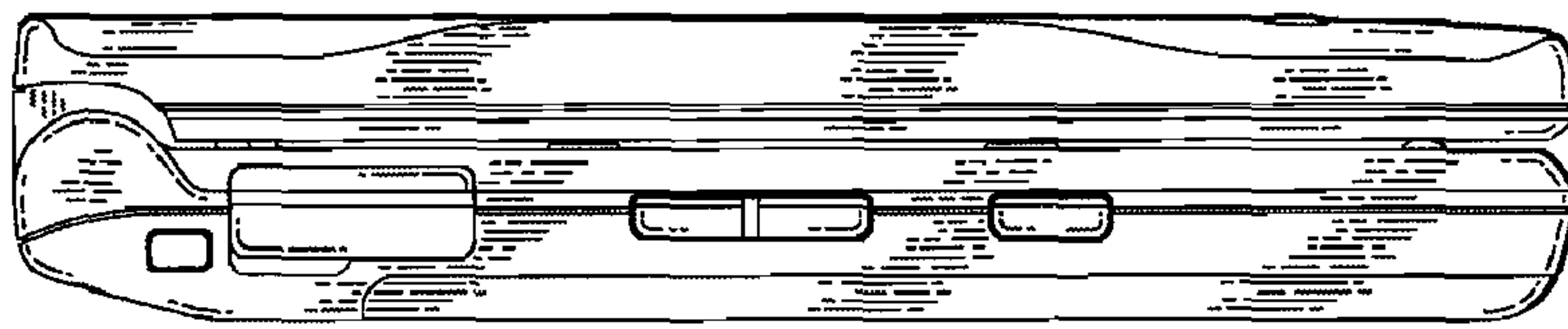

FIG. 5

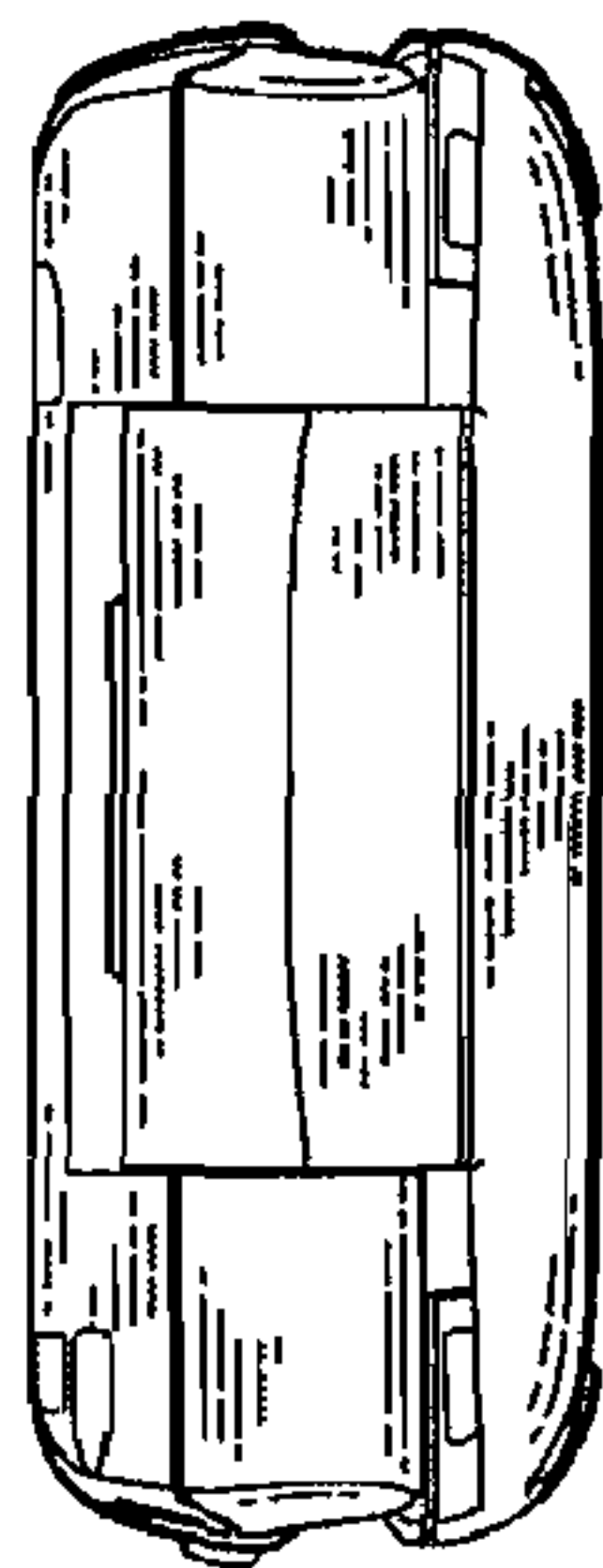

FIG. 6

