



US00D584264S

(12) **United States Design Patent**
Oh et al.

(10) **Patent No.:** **US D584,264 S**

(45) **Date of Patent:** **** *Jan. 6, 2009**

(54) **MOBILE PHONE**

(75) Inventors: **Jong Hoon Oh**, Seoul (KR); **Young Ju Yeo**, Seoul (KR); **Chang Hwan Hwang**, Seoul (KR)

(73) Assignee: **Samsung Electronics Co., Ltd.**, Suwon (KR)

(*) Notice: This patent is subject to a terminal disclaimer.

(**) Term: **14 Years**

(21) Appl. No.: **29/289,558**

(22) Filed: **Jul. 25, 2007**

(51) **LOC (9) Cl.** **14-03**

(52) **U.S. Cl.** **D14/138 AB**

(58) **Field of Classification Search** D14/138,
D14/496, 341-347; 455/575.3, 575.1

See application file for complete search history.

(56) **References Cited**

U.S. PATENT DOCUMENTS

D450,672 S *	11/2001	Arbisi et al.	D14/138
D491,906 S *	6/2004	Okamatsu	D14/138
D496,014 S *	9/2004	Lodato et al.	D14/138
D501,189 S *	1/2005	Lodato et al.	D14/138
D505,124 S *	5/2005	Takada	D14/138
D507,553 S *	7/2005	Gotou et al.	D14/138
D508,034 S *	8/2005	Liao	D14/138
D510,080 S *	9/2005	Kim et al.	D14/138
D510,333 S *	10/2005	Lodato et al.	D14/138
D512,975 S *	12/2005	Tsai et al.	D14/138
D519,096 S *	4/2006	Kanaoka et al.	D14/138
D522,988 S *	6/2006	Sheu	D14/138
D524,785 S *	7/2006	Huang	D14/138
D525,224 S *	7/2006	Pitt et al.	D14/138
D536,686 S *	2/2007	Miyata	D14/138
D542,251 S *	5/2007	Koh et al.	D14/138
D555,125 S *	11/2007	Horimoto	D14/138
D555,615 S *	11/2007	Lodato et al.	D14/138
D556,720 S *	12/2007	Lee	D14/138

D557,232 S *	12/2007	Lee	D14/138
D559,820 S *	1/2008	Lee	D14/138
D560,184 S *	1/2008	Hunt et al.	D14/138
D561,717 S *	2/2008	Park et al.	D14/138
D563,930 S *	3/2008	Kim et al.	D14/138
D565,007 S *	3/2008	Nara	D14/138
D566,675 S *	4/2008	Lee	D14/138
D568,855 S *	5/2008	Wang	D14/138
2006/0142053 A1 *	6/2006	Garcia et al.	455/556.1

OTHER PUBLICATIONS

Nokia 2760 telephone, announced May 2007, [online], [site visited Jun. 20, 2008]. Available from Internet ,<URL: <http://www.gsmarena.com>>.*

Sony Ericsson R306 Radio telephone, announced Jan. 2008, [online], [site visited Jun. 20, 2008]. Available from Internet ,<URL: <http://www.gsmarena.com>>.*

Sony Ericsson W710 telephone, announced May 2006, [online], [site visited Jun. 20, 2008]. Available from Internet ,<URL: <http://www.gsmarena.com>>.*

Asus M307 telephone, announced Mar. 2006, [online], [site visited Jun. 20, 2008]. Available from Internet ,<URL: <http://www.gsmarena.com>>.*

(Continued)

Primary Examiner—Jeffrey D Asch

(74) *Attorney, Agent, or Firm*—Ladas and Parry LLP

(57)

CLAIM

We claim the ornamental design for mobile phone, as shown.

DESCRIPTION

FIG. 1 is a front/right-side/top perspective view of a mobile phone showing our new design;

FIG. 2 is a front elevational view thereof;

FIG. 3 is a rear elevational view thereof;

FIG. 4 is a left-side elevational view thereof;

FIG. 5 is a right-side elevational view thereof,

FIG. 6 is a top plan view thereof; and

FIG. 7 is a bottom plan view thereof; and,

FIG. 8 is a a front/right-side/top perspective view thereof when mobile phone is open.

1 Claim, 7 Drawing Sheets

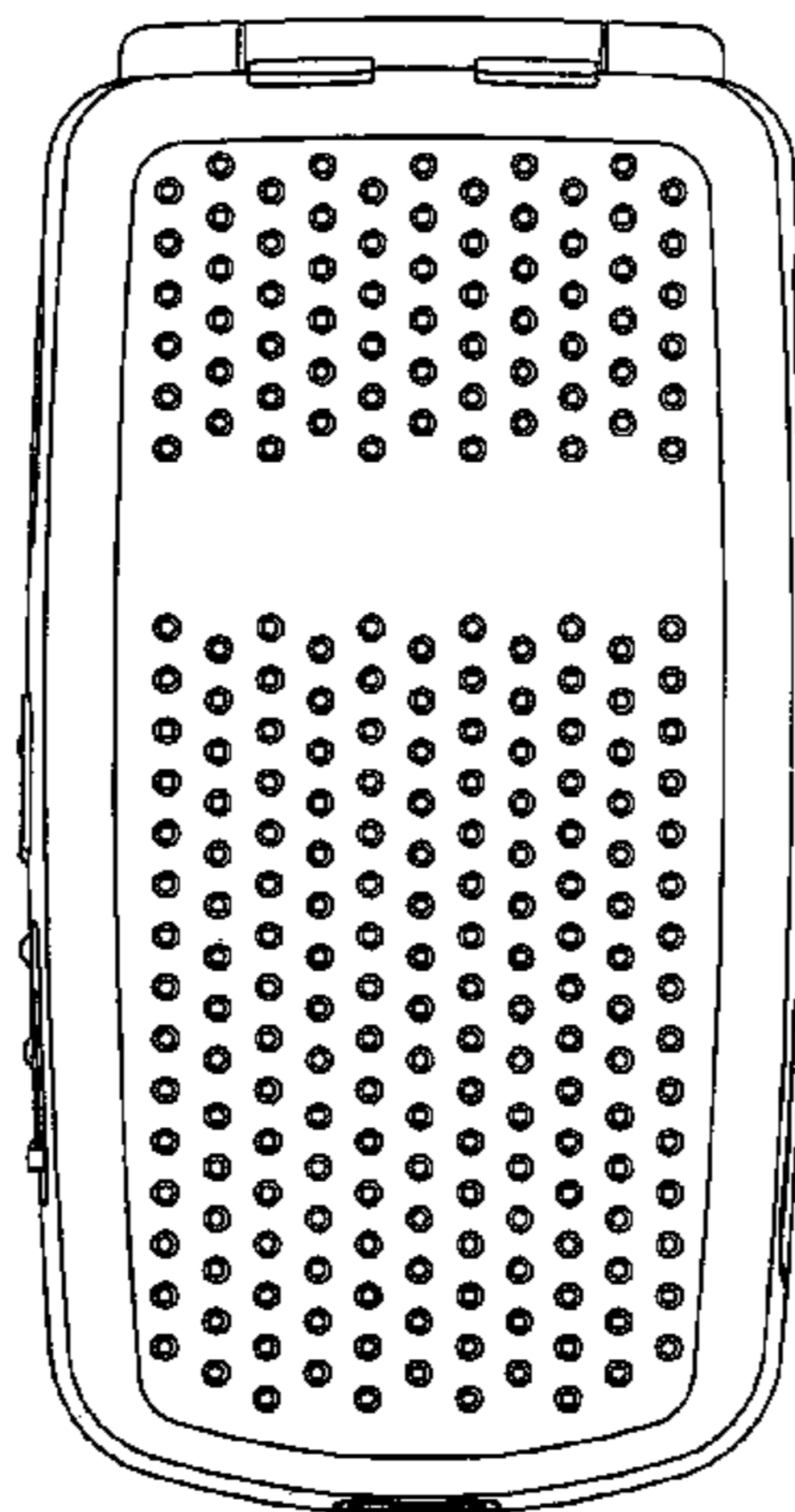
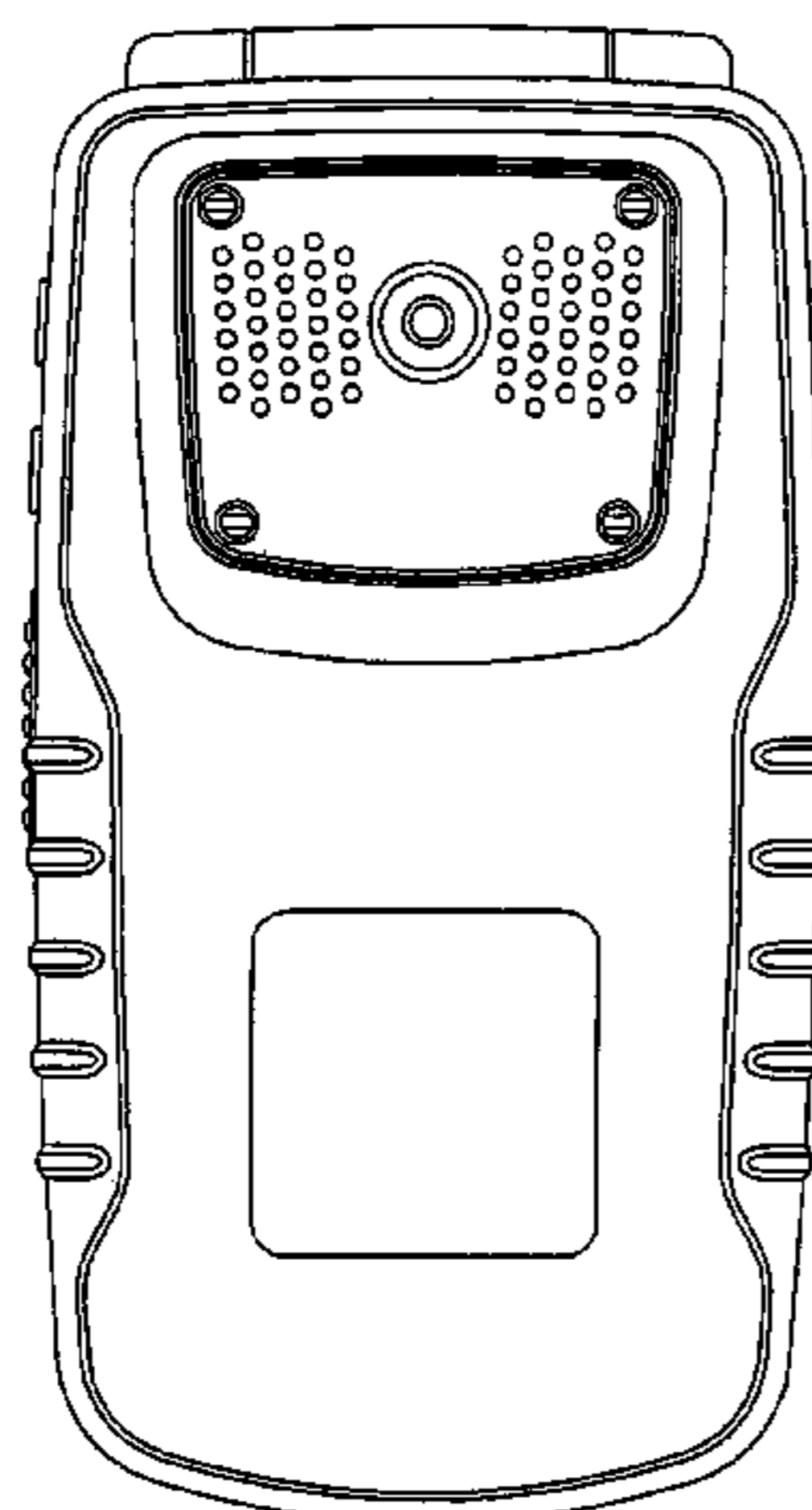

OTHER PUBLICATIONS

Sharp TM150 telephone, announced 3rd quarter 2004, [online], [site visited Jun. 20, 2008]. Available from Internet , <URL: <http://www.gsmarena.com>>.*

Panasonic SA7 telephone, announced 1st quarter 2005, [online], [site visited Jun. 20, 2008]. Available from Internet , <URL: <http://www.gsmarena.com>>.*

VK Mobile VK3100 telephone, announced 4th quarter 2005, [online], [site visited Jun. 20, 2008]. Available from Internet , <URL: <http://www.gsmarena.com>>.*

Bird DV10 telephone, announced 1st quarter 2005, [online], [site visited Jun. 20, 2008]. Available from Internet , <URL: <http://www.gsmarena.com>>.*

* cited by examiner

FIG. 1

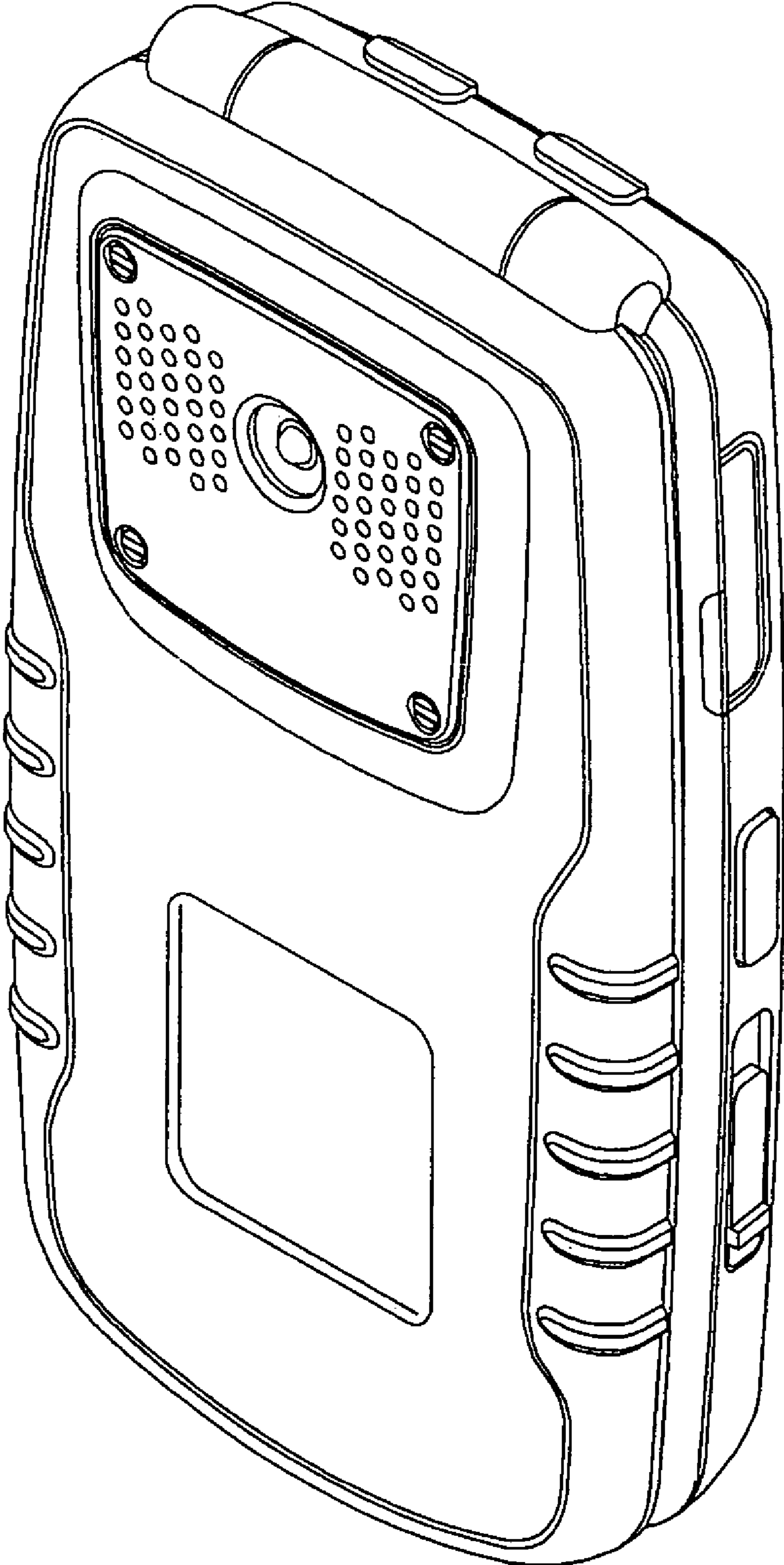

FIG. 2

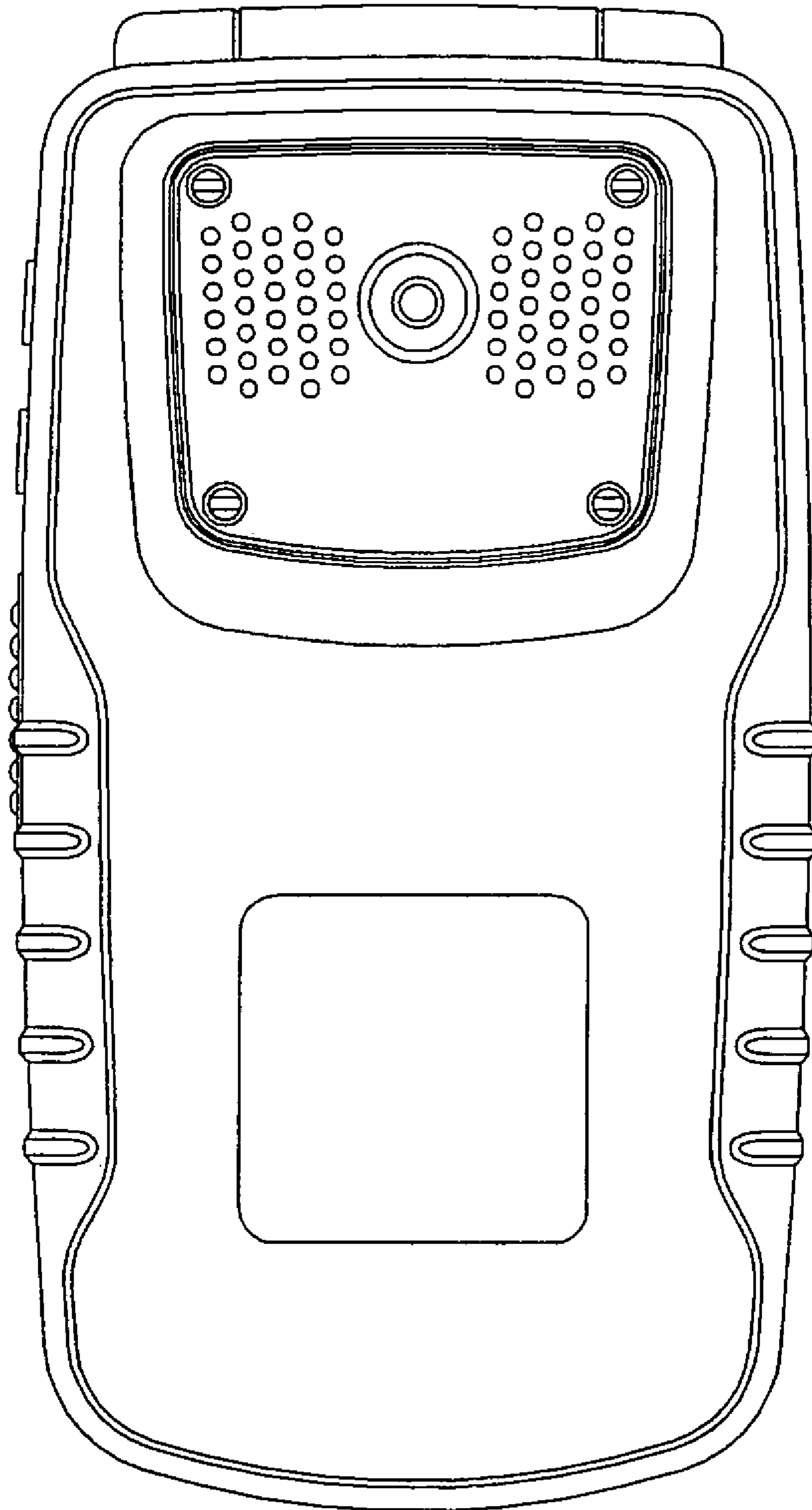

FIG. 3

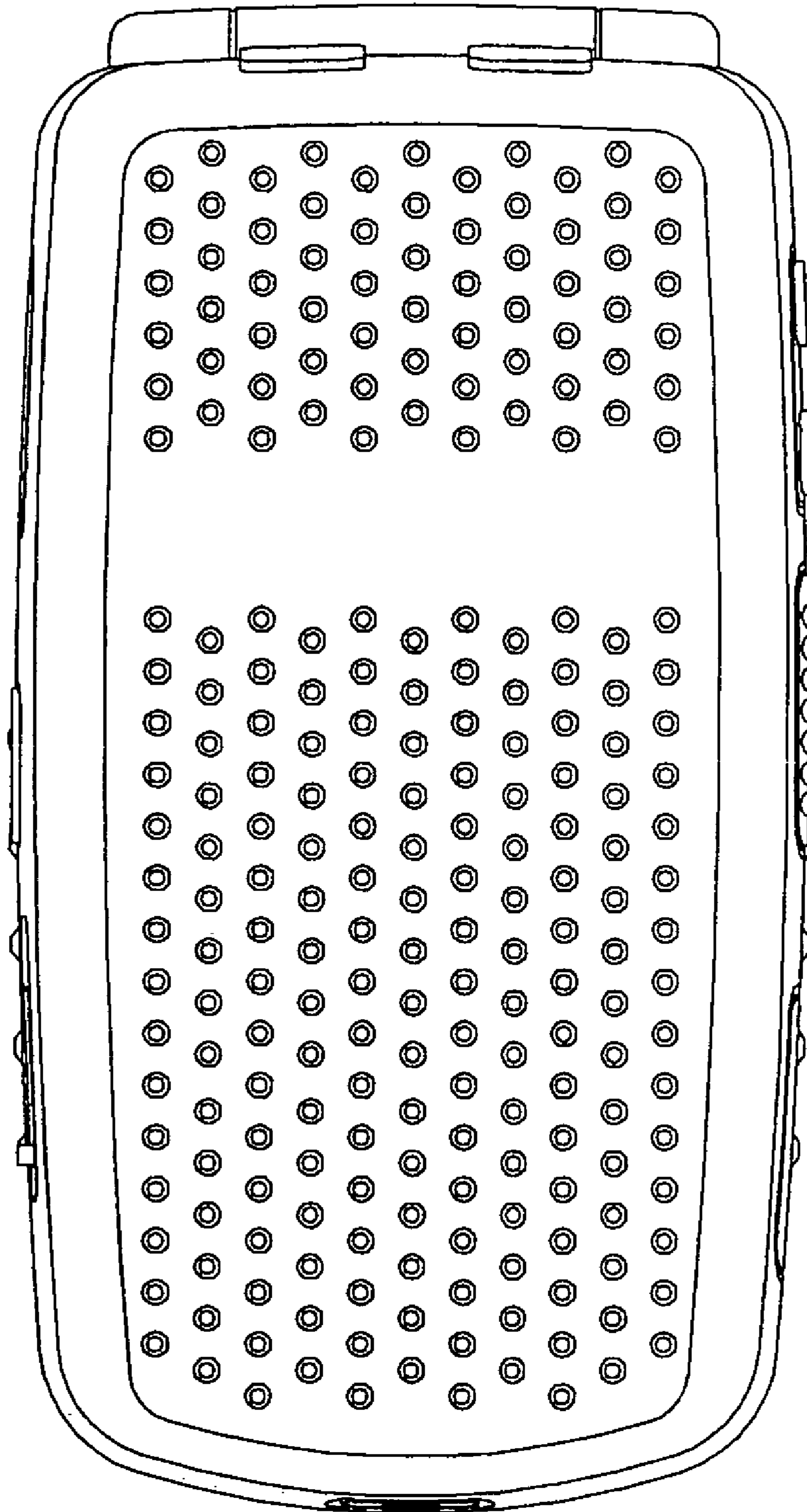

FIG. 4

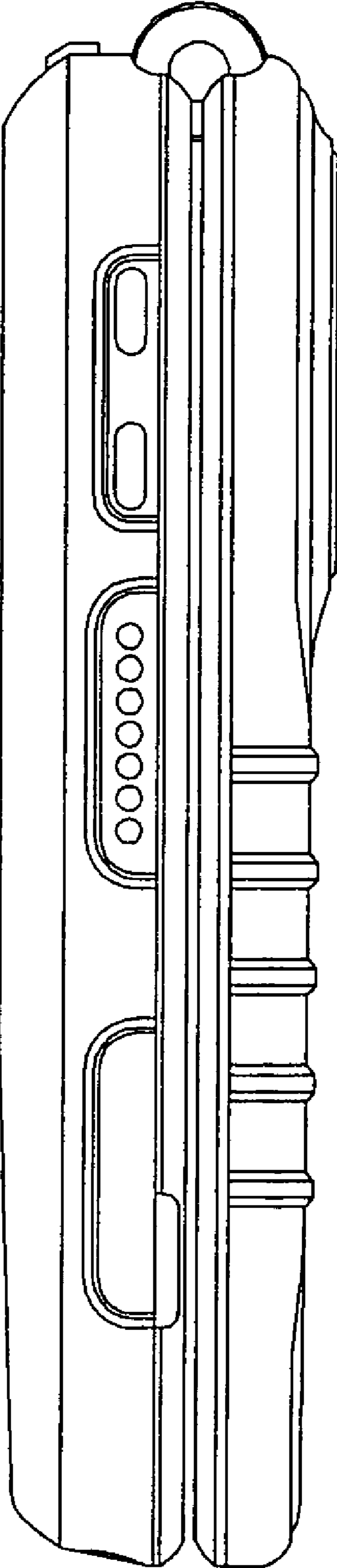

FIG. 5

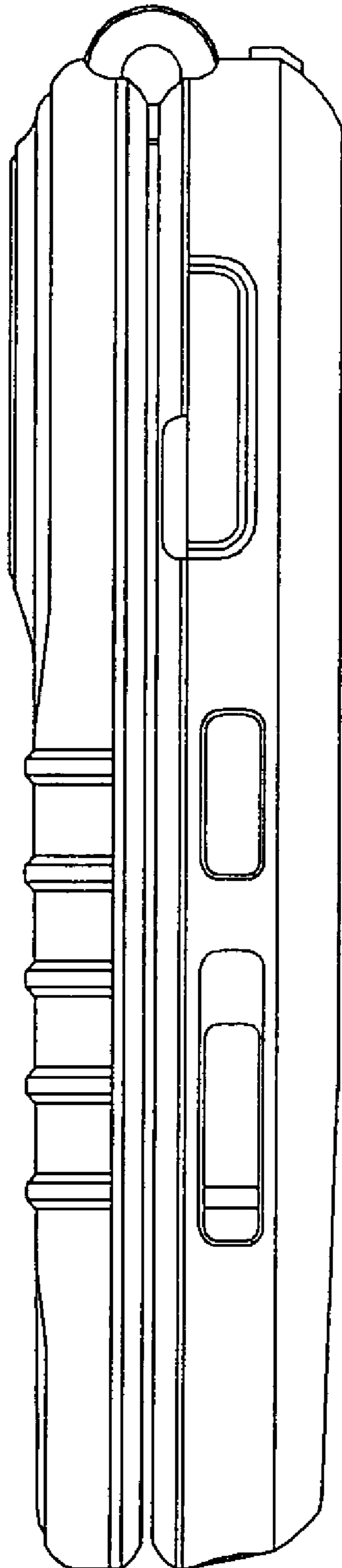

FIG. 6

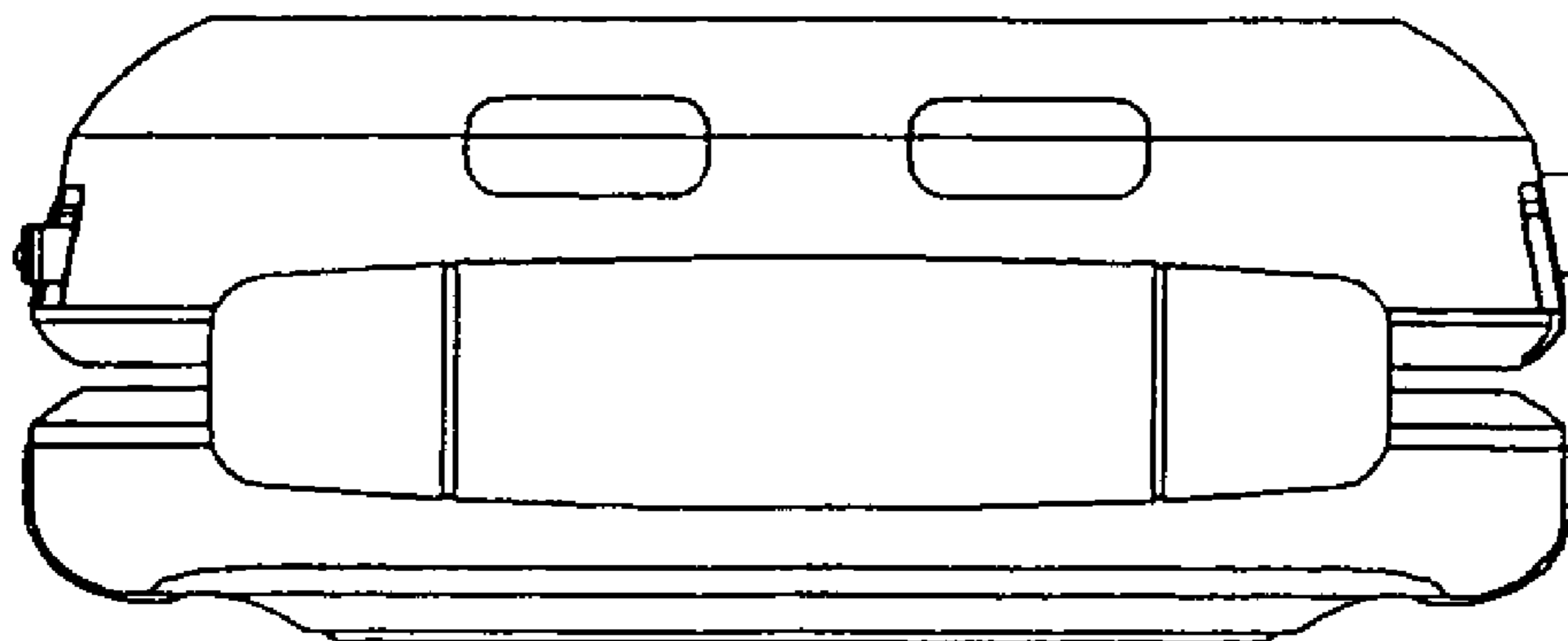

FIG. 7

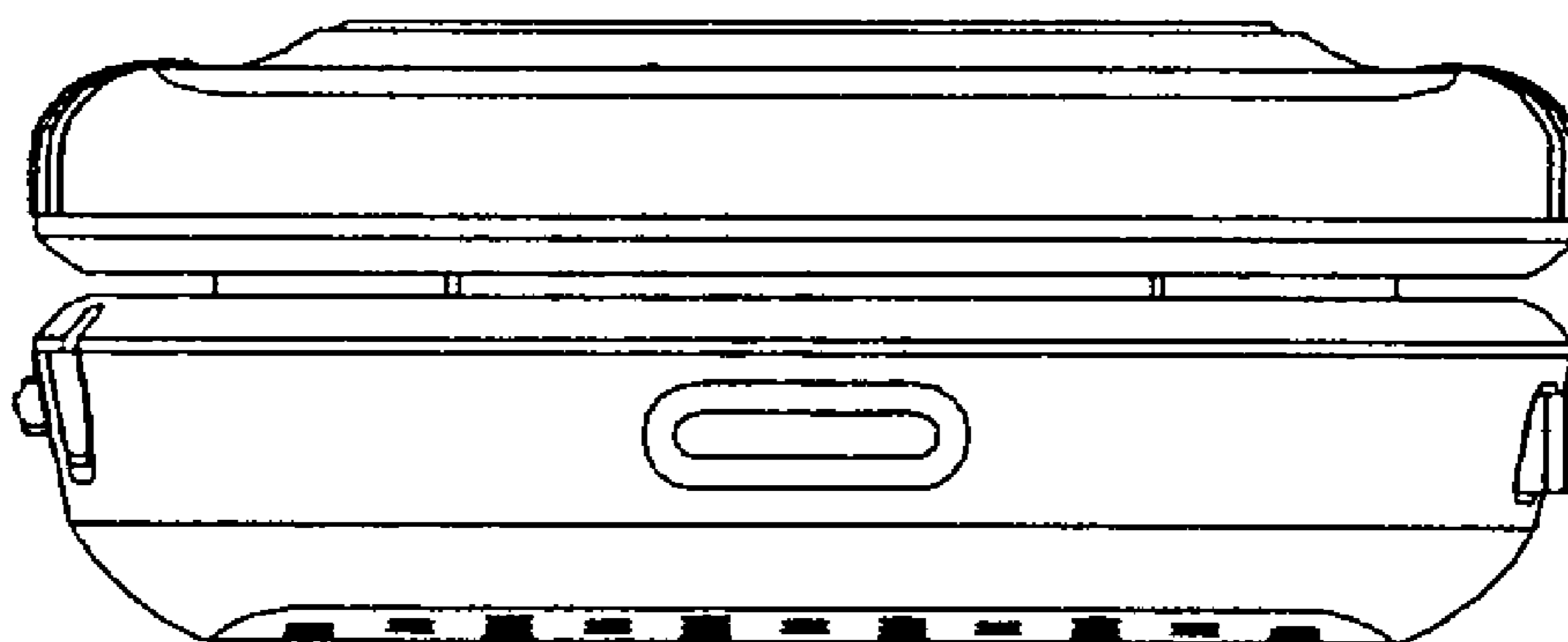

FIG. 8

