



US00D584256S

(12) **United States Design Patent**
Kita

(10) **Patent No.:** **US D584,256 S**
(45) **Date of Patent:** **** Jan. 6, 2009**

(54) **TELEVISION SET**

(75) Inventor: **Toshiyuki Kita**, Osaka (JP)

(73) Assignee: **Sharp Kabushiki Kaisha**, Osaka (JP)

(**) Term: **14 Years**

(21) Appl. No.: **29/290,464**

(22) Filed: **Dec. 7, 2007**

(30) **Foreign Application Priority Data**
 Jun. 14, 2007 (JP) 2007-015802

(51) **LOC (9) Cl.** **14-03**

(52) **U.S. Cl.** **D14/126**

(58) **Field of Classification Search** D14/125-134,
 D14/239, 371, 136, 374-377, 440, 450, 448,
 D14/336, 342; 312/7.2; 348/836, 838, 180,
 348/184, 325, 739; 341/12; 248/917-924,
 248/465; 345/104, 133, 156, 168, 87, 173;
 720/605, 669, 600, 655; 369/99, 197; 455/344,
 455/347; D21/329, 515, 577, 622, 333, 433,
 D21/448, 452, 450, 331; D6/477, 479; 273/148 B;
 446/484, 175, 356; D10/15, 26

See application file for complete search history.

D438,848 S 3/2001 Kita
 D439,224 S 3/2001 Kita
 D439,225 S 3/2001 Kita
 D453,747 S 2/2002 Kita
 D453,748 S 2/2002 Kita
 D456,370 S 4/2002 Kita
 D458,910 S 6/2002 Kita
 D492,269 S 6/2004 Kita
 D496,915 S 10/2004 Kita
 D497,351 S 10/2004 Kita
 D497,599 S 10/2004 Kita
 D499,076 S 11/2004 Kita
 D501,186 S 1/2005 Kita
 D501,654 S 2/2005 Kita
 D502,451 S 3/2005 Kita
 D502,931 S 3/2005 Kita
 D505,123 S 5/2005 Kita
 D510,731 S 10/2005 Kita
 D512,385 S 12/2005 Kita
 D512,386 S 12/2005 Kita
 D512,387 S 12/2005 Kita
 D536,678 S 2/2007 Kita
 D538,242 S 3/2007 Kita
 D538,762 S 3/2007 Fuji et al.
 D538,763 S 3/2007 Fuji et al.
 D539,766 S 4/2007 Kita

(Continued)

OTHER PUBLICATIONS

Totsuka, entitled, "Television Set," U.S. Appl. No. 29/245,754, filed Dec. 29, 2005, abandoned.

(Continued)

Primary Examiner—Raphael Barkai
(74) *Attorney, Agent, or Firm*—Nixon & Vanderhye, P.C.

(56) **References Cited**

U.S. PATENT DOCUMENTS

D337,113 S 7/1993 Saito
 D342,497 S 12/1993 Saito et al.
 D342,501 S 12/1993 Saeki et al.
 D351,155 S 10/1994 Usami et al.
 D351,156 S 10/1994 Usami et al.
 D357,244 S 4/1995 Usami et al.
 D357,245 S 4/1995 Usami et al.
 D357,472 S 4/1995 Usami et al.
 D369,596 S 5/1996 Akiyama et al.
 D372,026 S 7/1996 Akiyama et al.
 D373,583 S 9/1996 Akiyama et al.
 D427,169 S 6/2000 Saeki et al.
 D429,227 S 8/2000 Shimizu
 D431,537 S 10/2000 Saeki et al.

(57) **CLAIM**

The ornamental design for a "television set," as shown and described.

DESCRIPTION

FIG. 1 is a perspective view of a television set in accordance with my new design;
FIG. 2 is a front elevation view thereof;

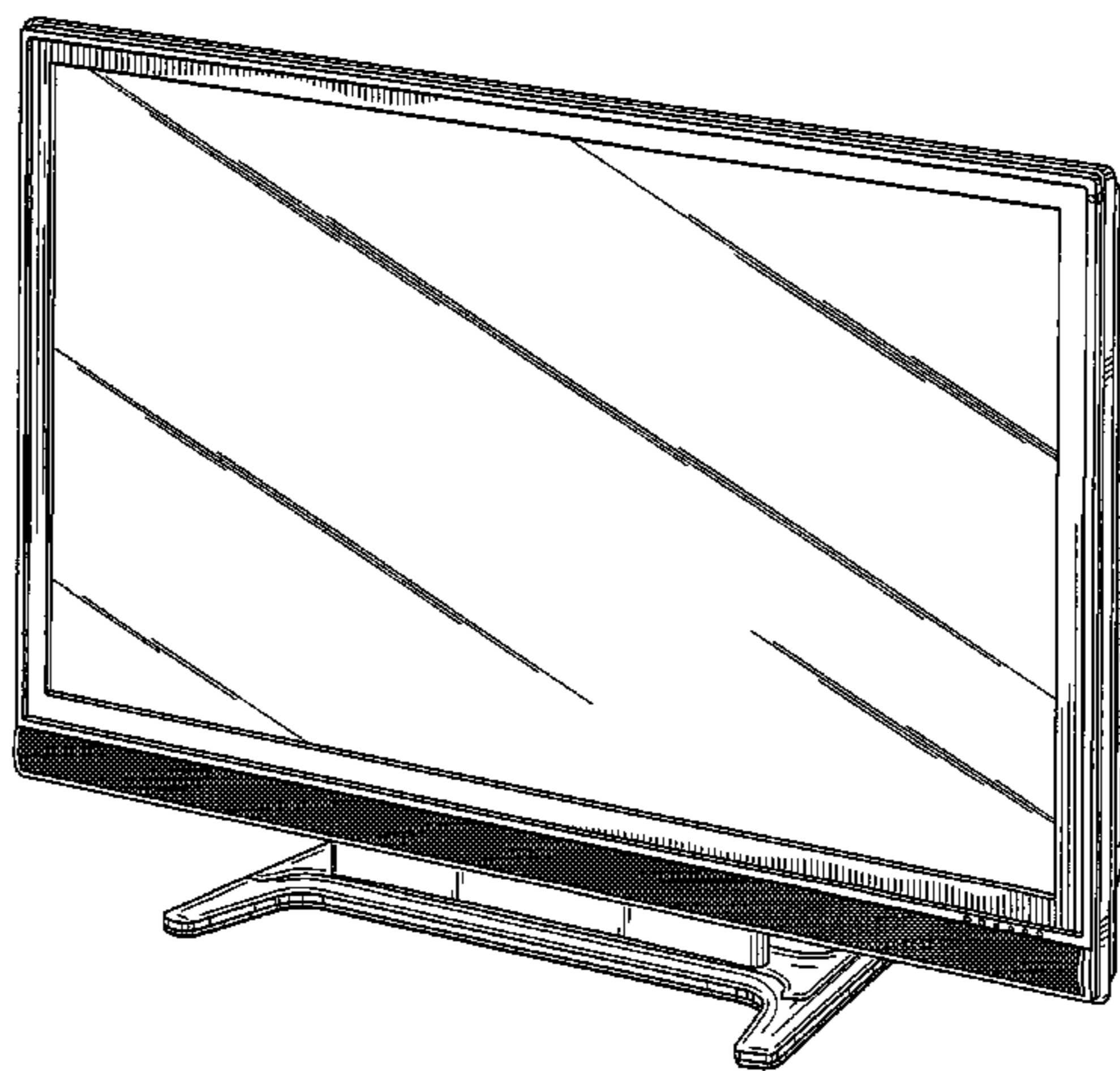

FIG. 3 is a rear elevation view thereof;
 FIG. 4 is a top plan view thereof;
 FIG. 5 is a bottom plan view thereof;
 FIG. 6 is a right side elevational view thereof; and,
 FIG. 7 is a left side elevational view thereof.

1 Claim, 5 Drawing Sheets

U.S. PATENT DOCUMENTS

| | | |
|------------|---------|--------------|
| D540,281 S | 4/2007 | Kita |
| D540,282 S | 4/2007 | Kita |
| D540,284 S | 4/2007 | Kita |
| D540,285 S | 4/2007 | Kita |
| D541,240 S | 4/2007 | Kita |
| D541,772 S | 5/2007 | Kita |
| D541,774 S | 5/2007 | Kita |
| D541,775 S | 5/2007 | Kita |
| D543,519 S | 5/2007 | Kita |
| D544,850 S | 6/2007 | Kita |
| D545,282 S | 6/2007 | Kita |
| D545,779 S | 7/2007 | Kita |
| D545,780 S | 7/2007 | Kita |
| D546,301 S | 7/2007 | Kita |
| D546,302 S | 7/2007 | Kita |
| D546,303 S | 7/2007 | Fujii et al. |
| D551,187 S | 9/2007 | Kita |
| D552,050 S | 10/2007 | Fujii et al. |
| D552,569 S | 10/2007 | Kita |
| D552,571 S | 10/2007 | Fujii et al. |
| D554,085 S | 10/2007 | Kita |

OTHER PUBLICATIONS

Kita, entitled, "Television Set," U.S. Appl. No. 29/243,707, filed Nov. 30, 2005, pending.
 Kita, entitled, "Externally Exposed Surfaces of a Speaker for a Television Set," U.S. Appl. No. 29/243,705, filed Nov. 30, 2005, allowed.
 Kita, entitled, "Television Set," U.S. Appl. No. 29/260,910, filed Jun. 21, 2006, allowed.
 Kita, entitled, "Television Set," U.S. Appl. No. 29/261,803, filed Jun. 21, 2006, allowed.
 Inuma et al., entitled, "Television Set," U.S. Appl. No. 29/261,809, filed Jun. 21, 2006, allowed.
 Inuma et al., entitled, "Television Set," U.S. Appl. No. 29/261,806, filed Jun. 21, 2006, pending.
 Fujii et al., entitled, "Television Set," U.S. Appl. No. 29/261,807, filed Jun. 21, 2006, allowed.
 Fujii et al., entitled, "Television Set," U.S. Appl. No. 29/260,910, filed Jun. 21, 2006, allowed.
 Fujii et al., entitled, "Television Set," U.S. Appl. No. 29/266,495, filed Sep. 22, 2006, allowed.
 Kita, entitled, "Television Set," U.S. Appl. No. 29/271,041, filed Jan. 9, 2007, pending.
 Kita., entitled, "Television Set," U.S. Appl. No. 29/271,043, filed Jan. 9, 2007, pending.
 Kita., entitled, "Television Set," U.S. Appl. No. 29/271,155, filed Jan. 11, 2007, pending.
 Kita., entitled, "Television Set," U.S. Appl. No. 29/271,156, filed Jan. 11, 2007, pending.
 Kita., entitled, "Television Set," U.S. Appl. No. 29/271,042, filed Jan. 9, 2007, pending.
 Fujii et al., entitled, "Television Set," U.S. Appl. No. 29/272,942, filed Feb. 22, 2007, pending.
 Fujii et al., entitled, "Television Set," U.S. Appl. No. 29/272,938, filed Feb. 22, 2007, pending.
 Fujii et al., entitled, "Television Set," U.S. Appl. No. 29/272,941, filed Feb. 22, 2007, allowed.
 Kita, entitled, "Television Set," U.S. Appl. No. 29/272,939, filed Feb. 22, 2007, allowed.
 Shimamoto, entitled, "Television Set," U.S. Appl. No. 29/272,940, filed Feb. 22, 2007, allowed.
 Shimamoto, entitled, "Television Set," U.S. Appl. No. 29/287,705, filed Sep. 10, 2007, pending.
 Kita, entitled, "Television Set," U.S. Appl. No. 29/290,465, filed Dec. 7, 2007, pending.

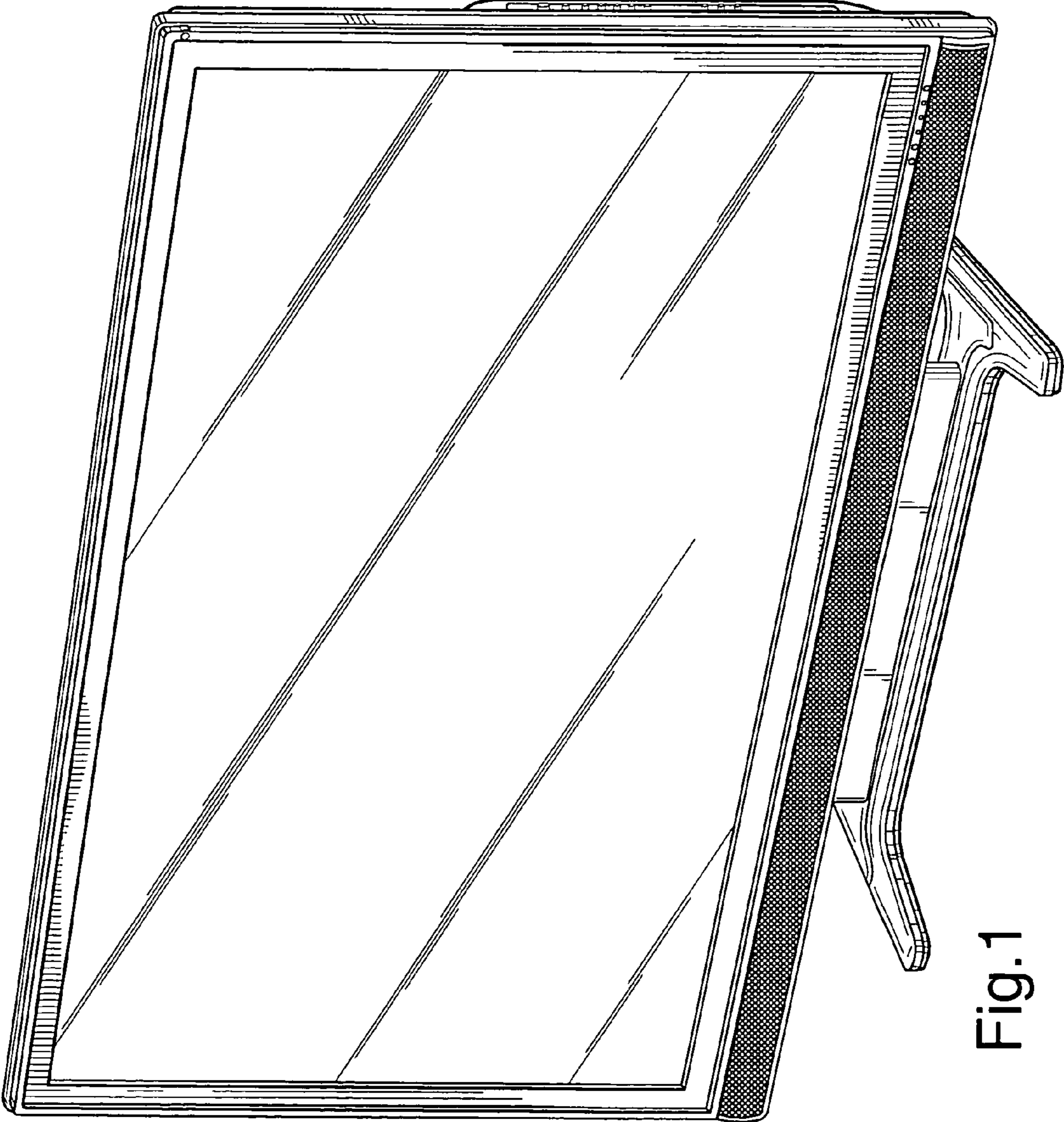

Fig.1

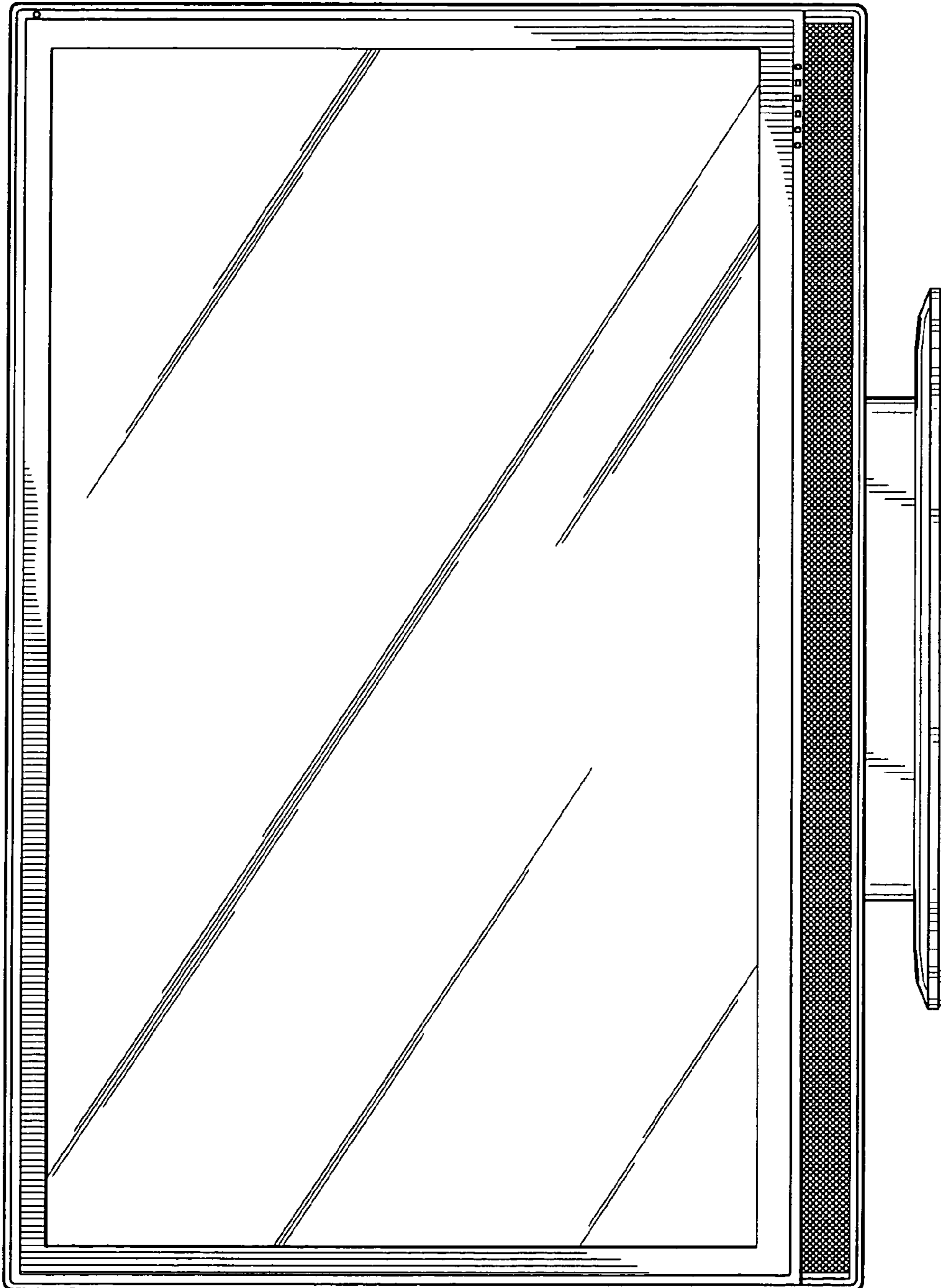

Fig.2

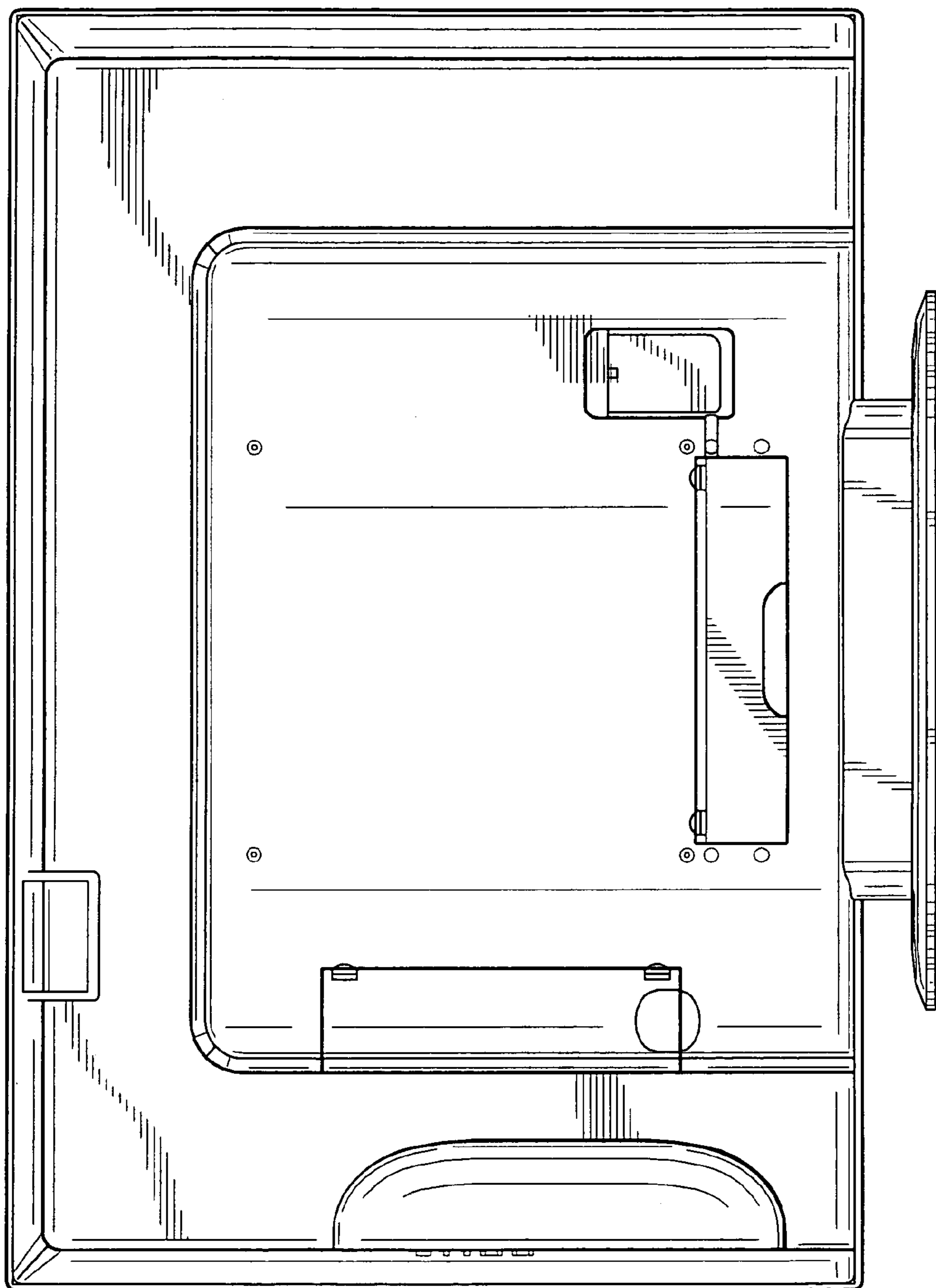

Fig. 3

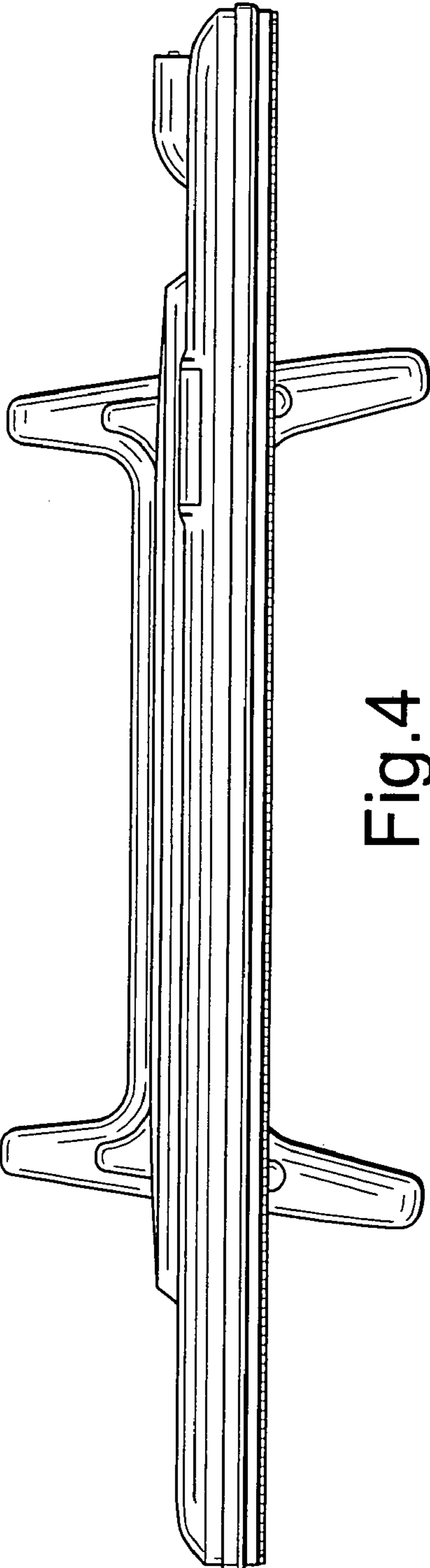

Fig.4

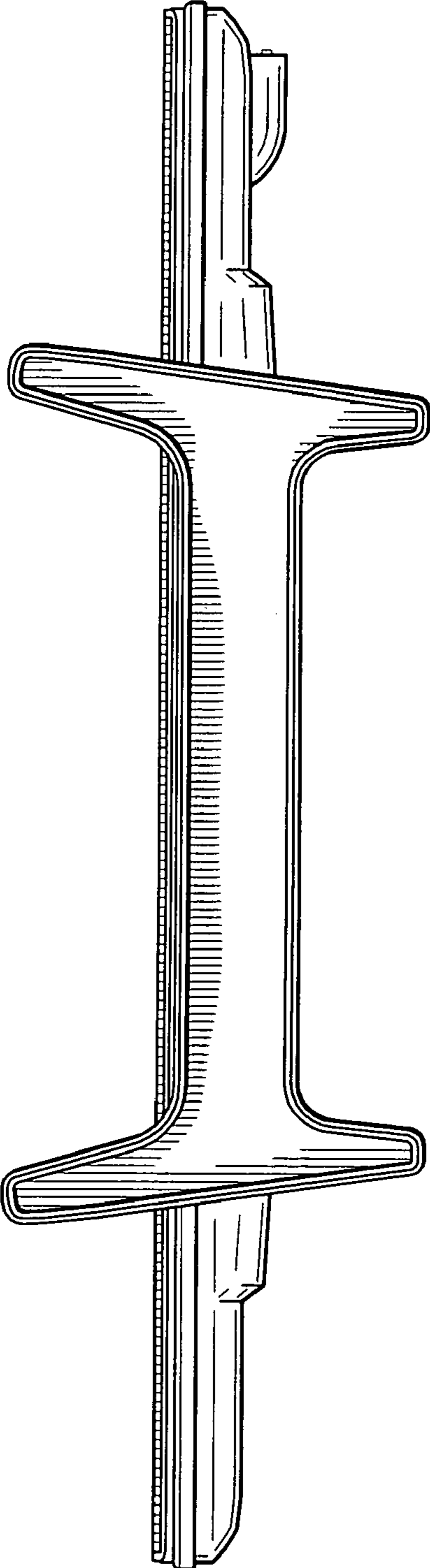

Fig.5

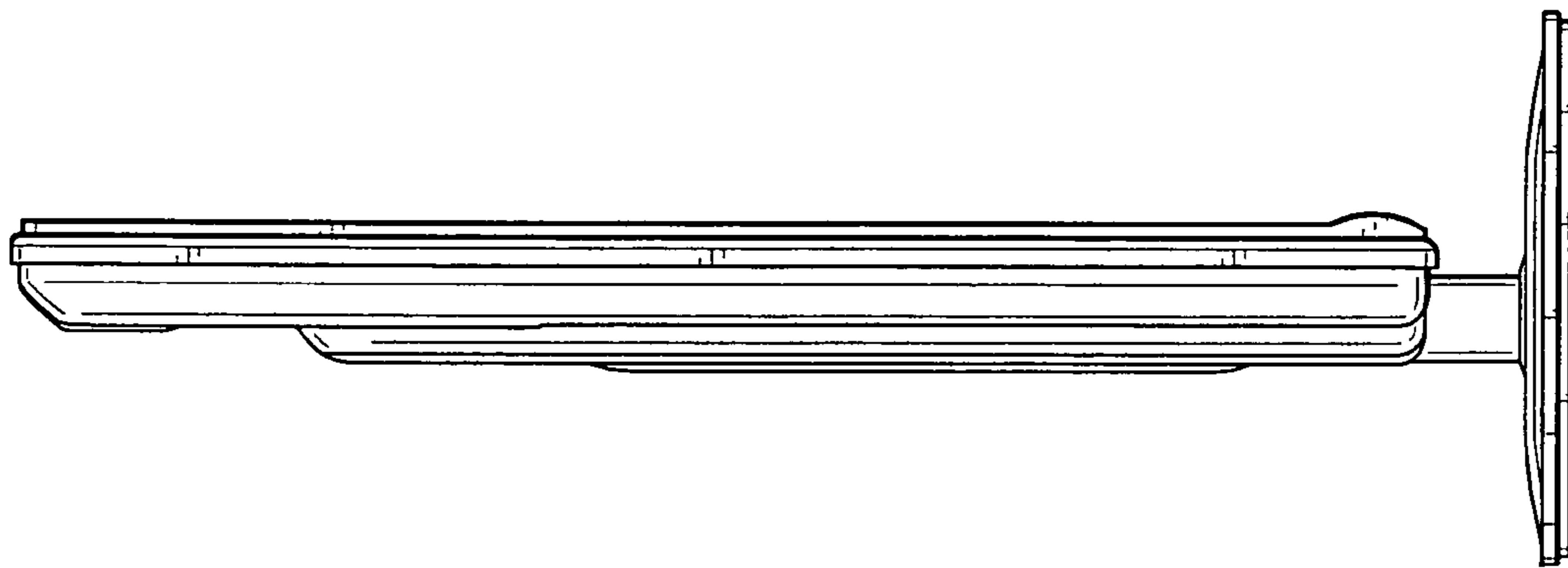

Fig.7

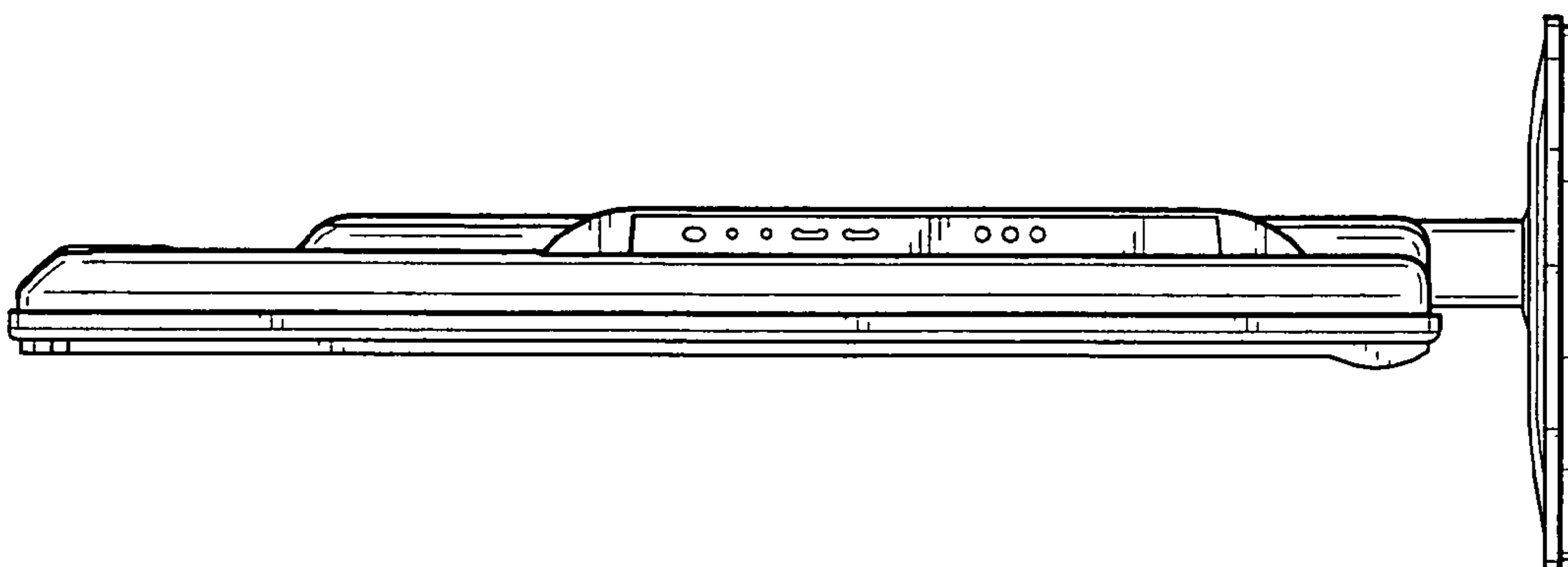

Fig.6