



US00D584194S

(12) **United States Design Patent**
Zweideck

(10) **Patent No.:** **US D584,194 S**
(45) **Date of Patent:** **** Jan. 6, 2009**

(54) **PUSHCHAIR WITH SEAT**

(75) Inventor: **M. Bruno Zweideck**, Cholet (FR)

(73) Assignee: **Ampafrance**, Cholet (FR)

(**) Term: **14 Years**

(21) Appl. No.: **29/201,802**

(22) Filed: **Mar. 19, 2004**

(30) **Foreign Application Priority Data**

Sep. 19, 2003 (FR) 03 4542

(51) **LOC (9) Cl.** **12-12**

(52) **U.S. Cl.** **D12/129**

(58) **Field of Classification Search** D12/128-133;
267/5; 135/65-67, 74, 912; 280/647-650,
280/29, 200, 250.1, 259, 642, 658; 297/DIG. 4;
296/65.03, 65.04; 224/409; D6/364

See application file for complete search history.

(56) **References Cited**

U.S. PATENT DOCUMENTS

D305,314 S *	1/1990	Julien	D12/129
D355,874 S *	2/1995	Nelson	D12/129
5,749,627 A *	5/1998	Perego	297/370
D396,832 S *	8/1998	Yang	D12/129
D427,550 S *	7/2000	Lee	D12/129
D429,184 S *	8/2000	Yang	D12/129
D434,704 S *	12/2000	Huang	D12/129
D463,330 S *	9/2002	Yang et al.	D12/129
D480,994 S *	10/2003	Grohmann	D12/129
D486,428 S *	2/2004	Daykin	D12/129
7,017,936 B2 *	3/2006	Huang	280/642
D528,948 S *	9/2006	Daykin	D12/129

OTHER PUBLICATIONS

Le Guide 2002, bébé confort, pp. 1-32, 2002.

* cited by examiner

Primary Examiner—Charles A Rademaker

Assistant Examiner—Charles D Hanson

(74) *Attorney, Agent, or Firm*—Workman Nydegger

(57) **CLAIM**

The ornamental design for a pushchair with seat, as shown and described.

DESCRIPTION

FIG. 1 is a perspective view of a pushchair with seat showing my new design;

FIG. 2 is a front view thereof;

FIG. 3 is a rear view thereof;

FIG. 4 is a right side view thereof;

FIG. 5 is a top view thereof;

FIG. 6 is a perspective view thereof, in a collapsed position;

FIG. 7 is a front view thereof;

FIG. 8 is rear view thereof;

FIG. 9 is a left side view thereof; and,

FIG. 10 is a top view thereof.

The broken lines showing the seat straps, wheel tread, logo, and grips are for illustrative purposes only and form no part of the claimed design.

The straps shown in broken lines in the drawings are for illustrative purposes only and form no part of the claimed design. The remaining broken lines shown in the drawings depict stitching.

1 Claim, 10 Drawing Sheets





FIG. 1

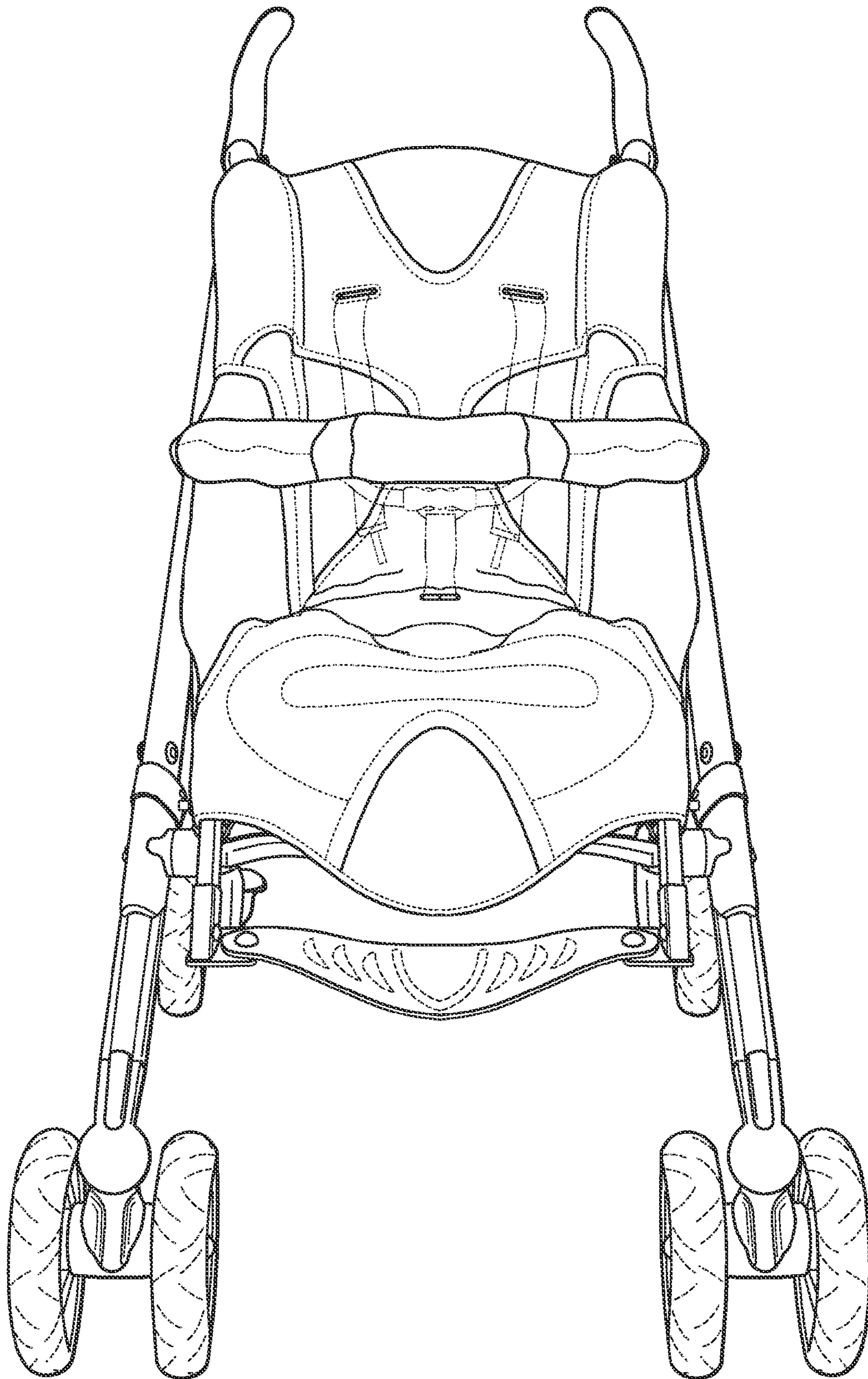

FIG. 2

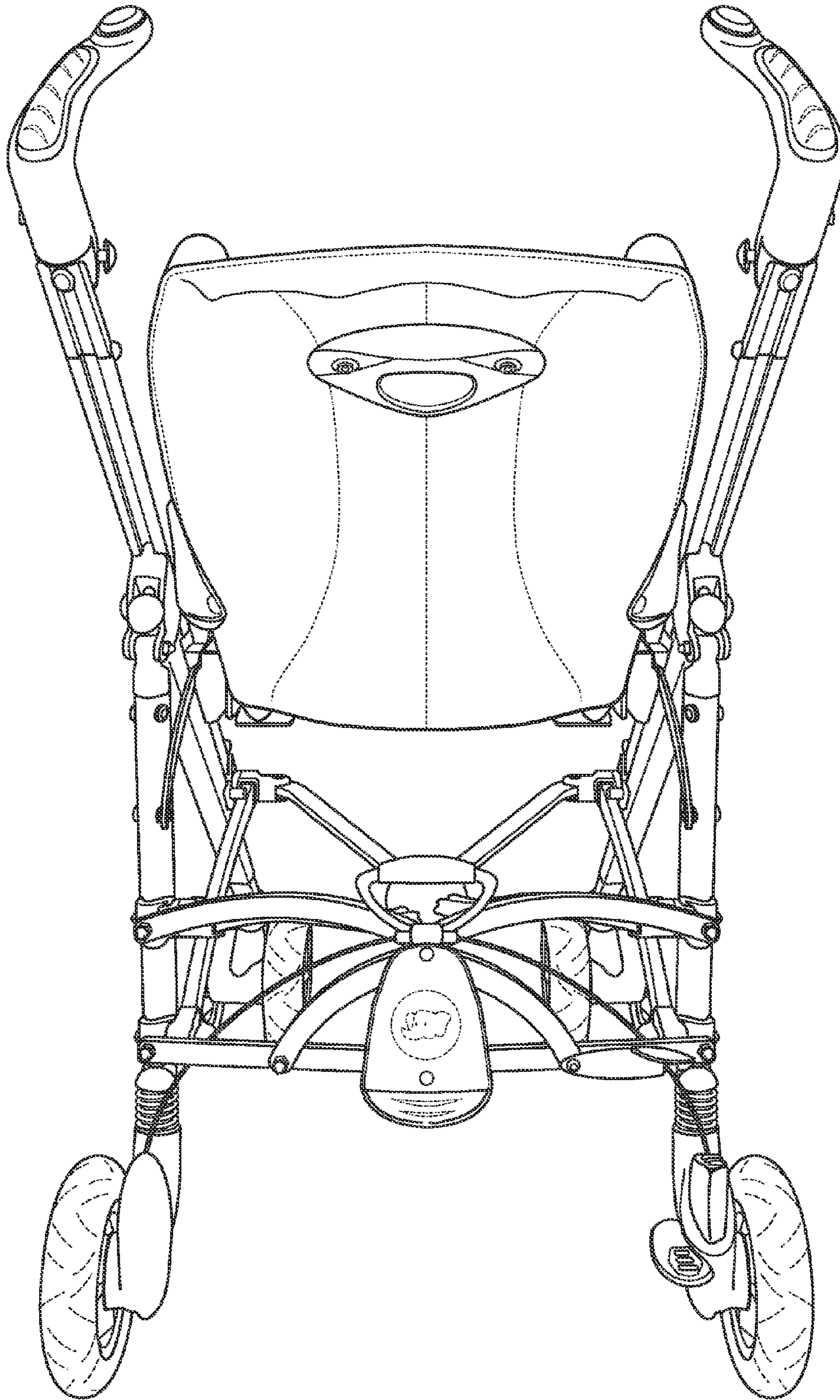

FIG. 3

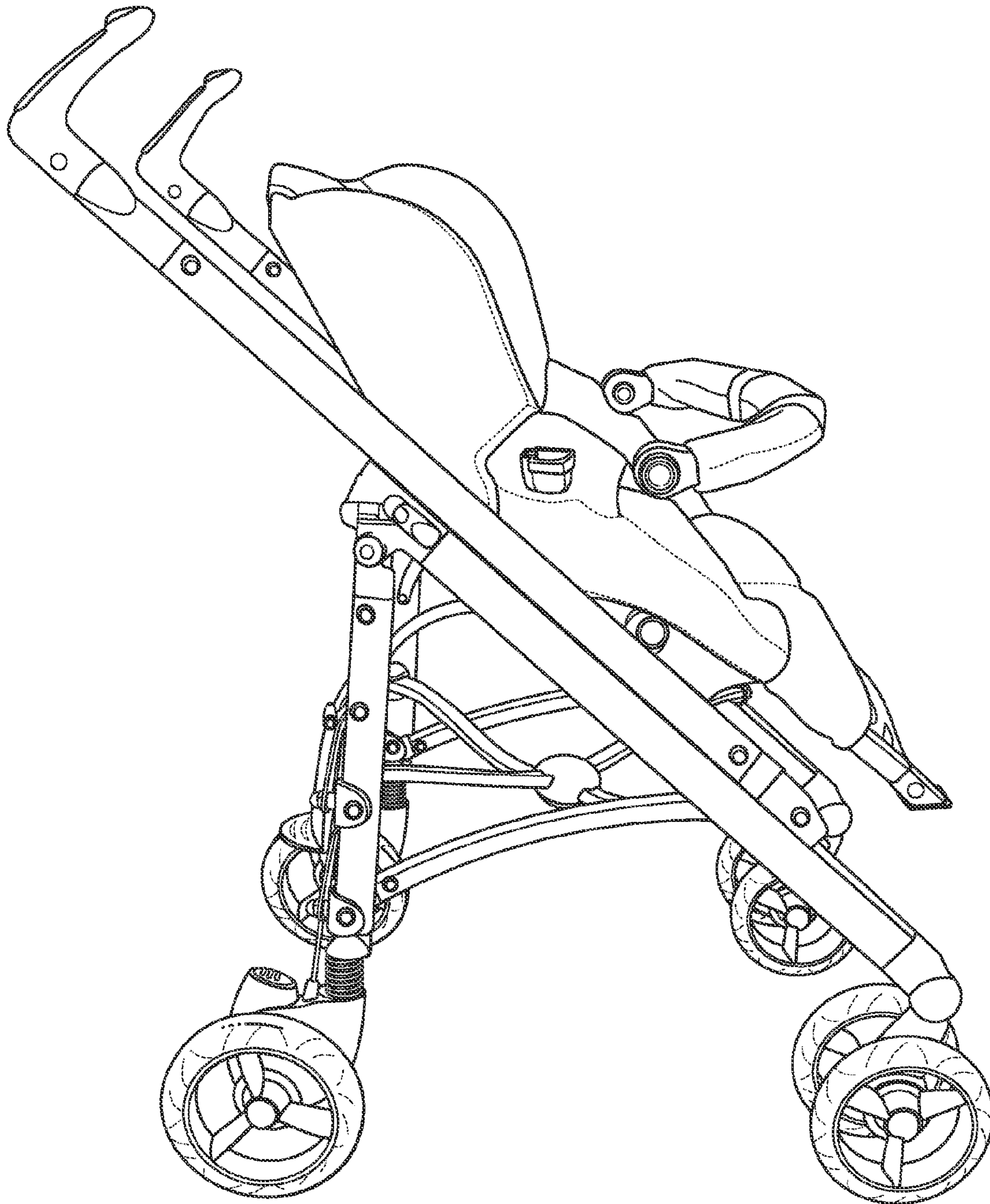

FIG. 4

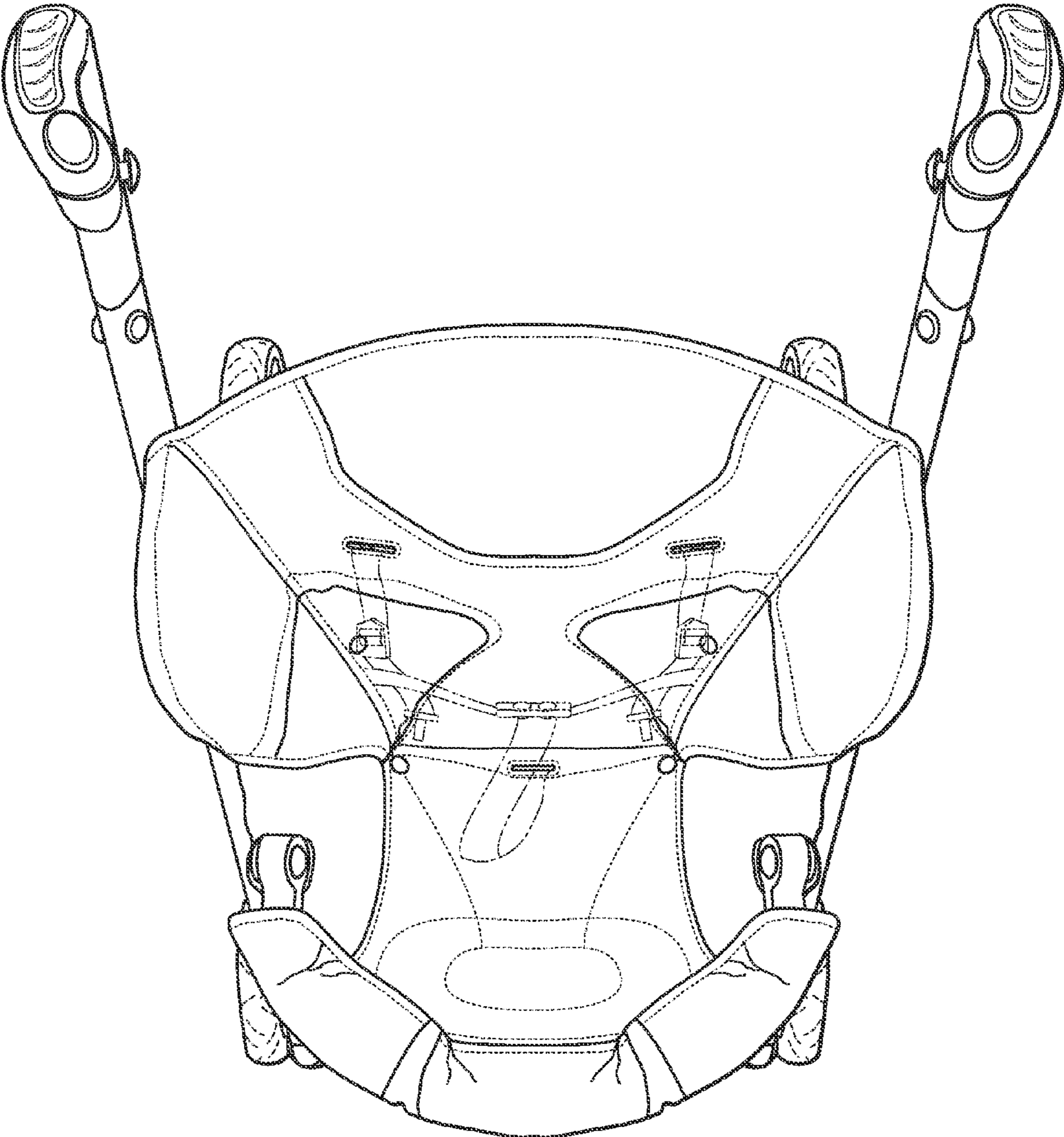

FIG. 5

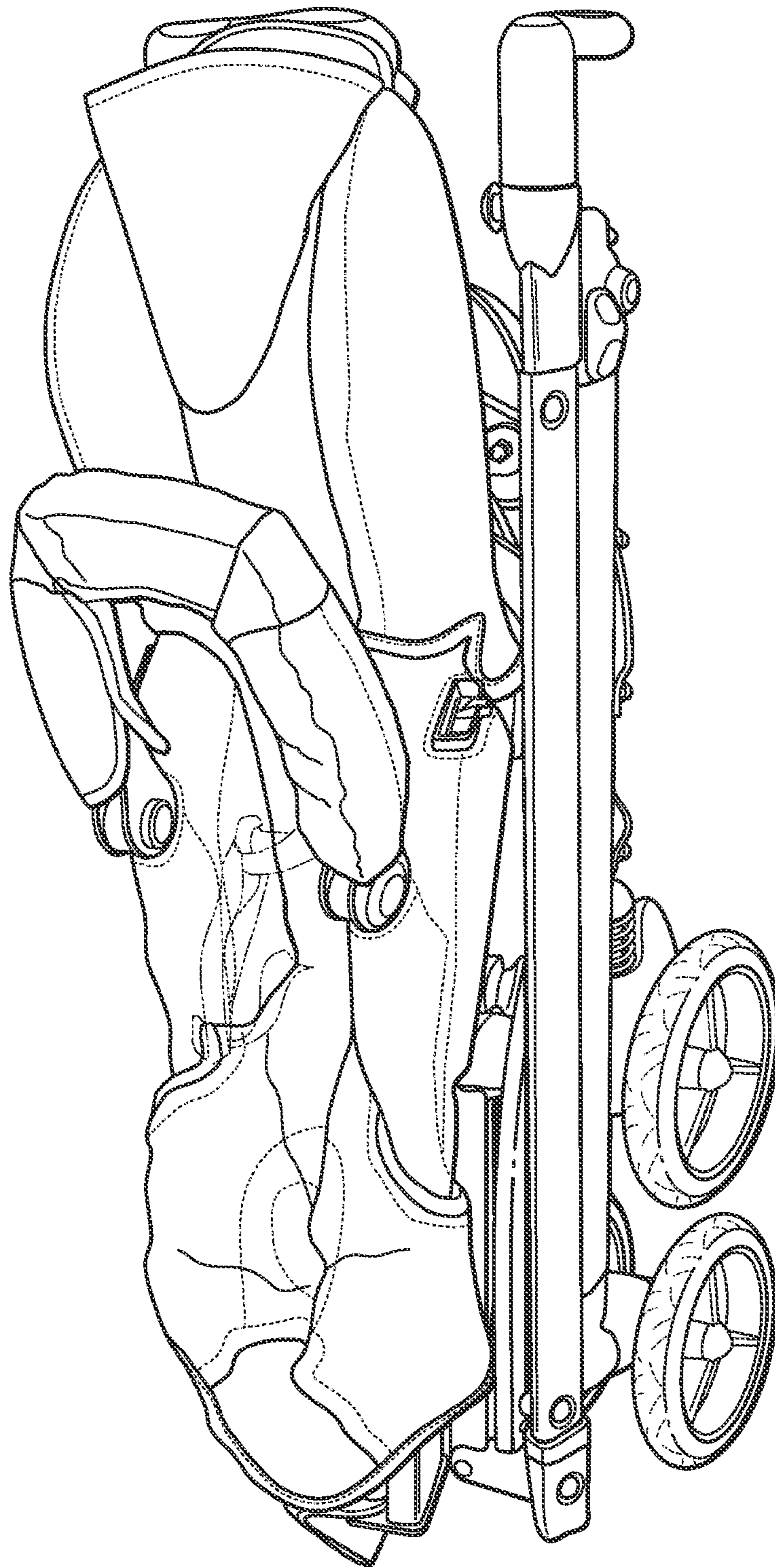

FIG. 6

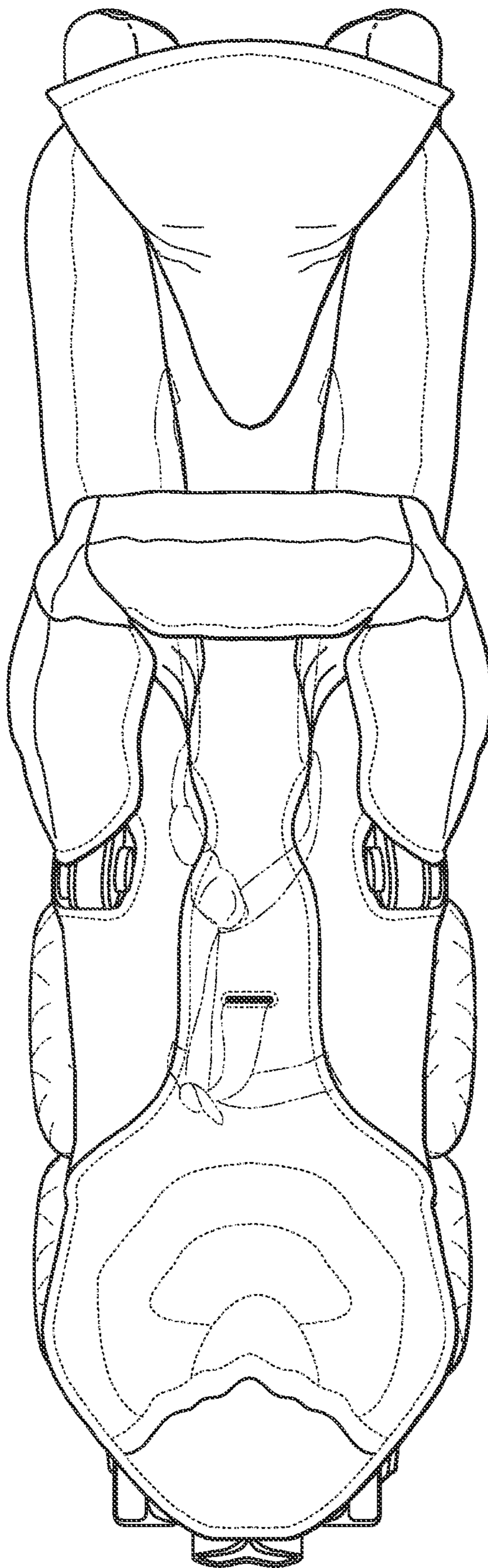

FIG. 7

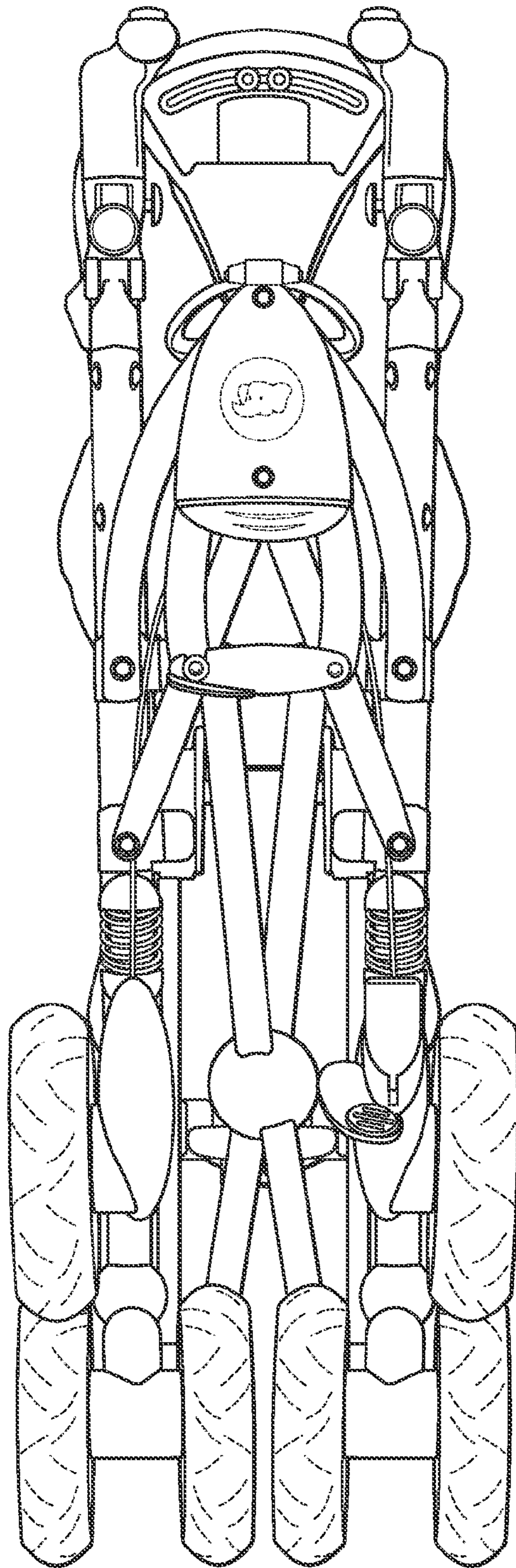

FIG. 8

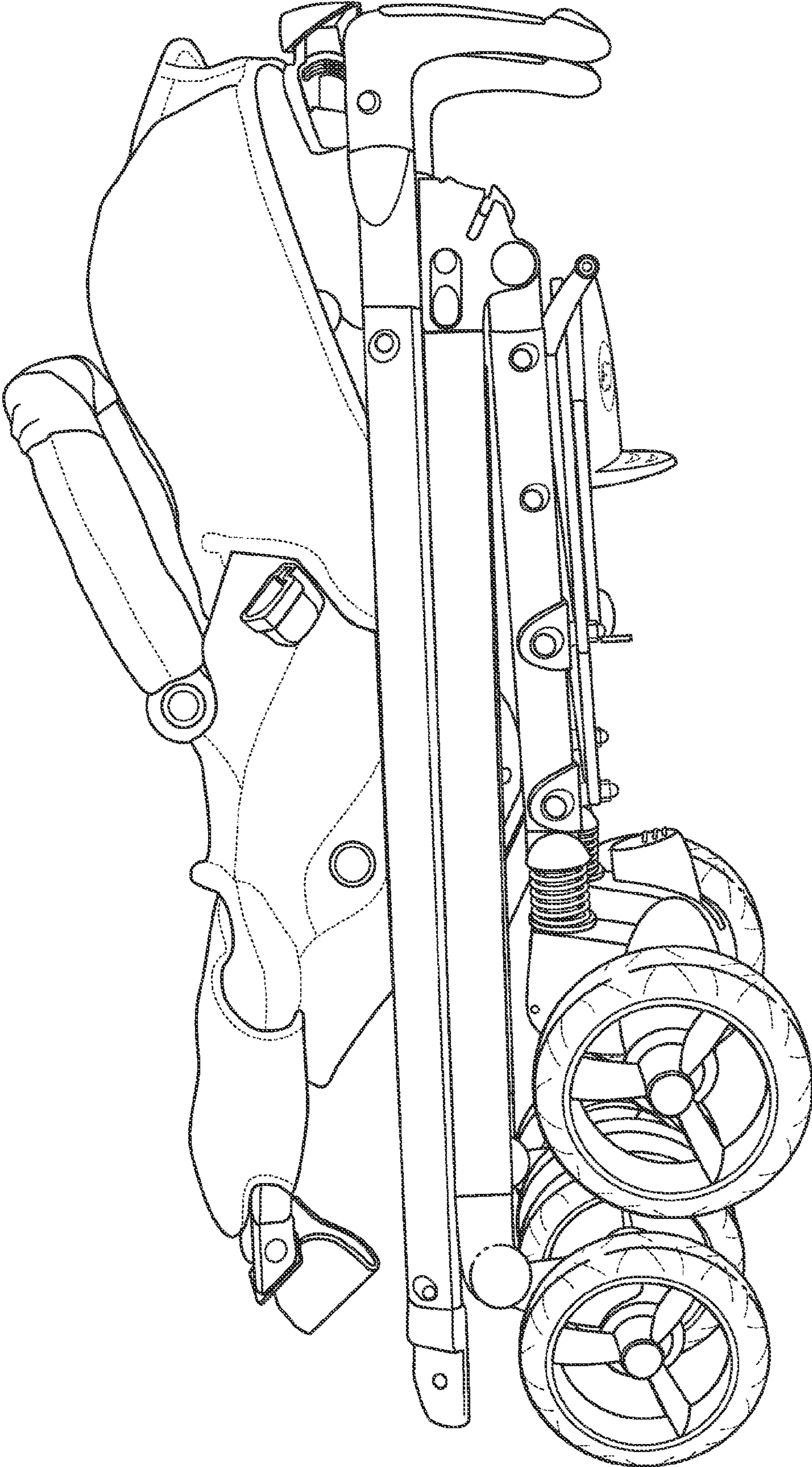

FIG. 9

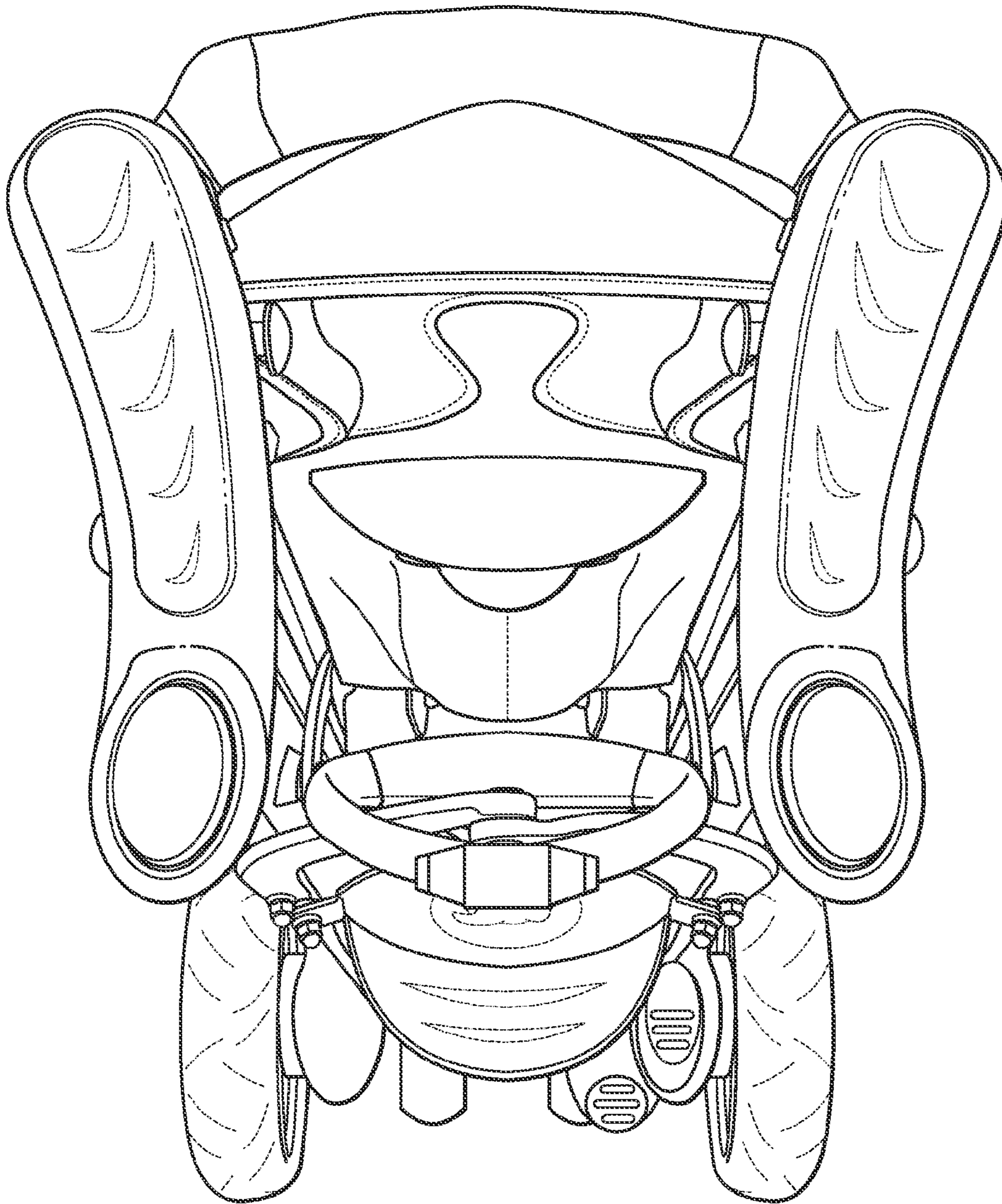

FIG. 10