



US00D584133S

(12) **United States Design Patent**
Stubdrup

(10) **Patent No.:** **US D584,133 S**
(45) **Date of Patent:** **** Jan. 6, 2009**

(54) **MOUNTING BRACKET FOR A TOILET SEAT**

(75) Inventor: **Lone Stubdrup**, Silkeborg (DK)

(73) Assignee: **Pressalit Group A/S**, Ry (DK)

(**) Term: **14 Years**

(21) Appl. No.: **29/270,414**

(22) Filed: **Dec. 22, 2006**

(51) **LOC (9) Cl.** **08-05**

(52) **U.S. Cl.** **D8/363**

(58) **Field of Classification Search** D8/363;
D6/546; 248/309.1; 4/661

See application file for complete search history.

(56) **References Cited**

U.S. PATENT DOCUMENTS

5,896,600 A * 4/1999 Mills et al. 4/661

* cited by examiner

Primary Examiner—Holly H Baynham
(74) *Attorney, Agent, or Firm*—Dykema Gossett PLLC

(57) **CLAIM**

The ornamental design for a mounting bracket for a toilet seat, as shown and described.

DESCRIPTION

FIG. 1 is a top plan view of my new design for a mounting bracket for a toilet seat,

FIG. 2 is a side view thereof,

FIG. 3 is a side perspective view thereof,

FIG. 4 is a perspective view of the bar element thereof,

FIG. 5 is a side view of the bar element,

FIG. 6 is an enlarged perspective view of a support post thereof; and,

FIG. 7 is an enlarged side view of the support post.

The elements of the claimed design are shown separately for ease and clarity of illustration.

1 Claim, 7 Drawing Sheets



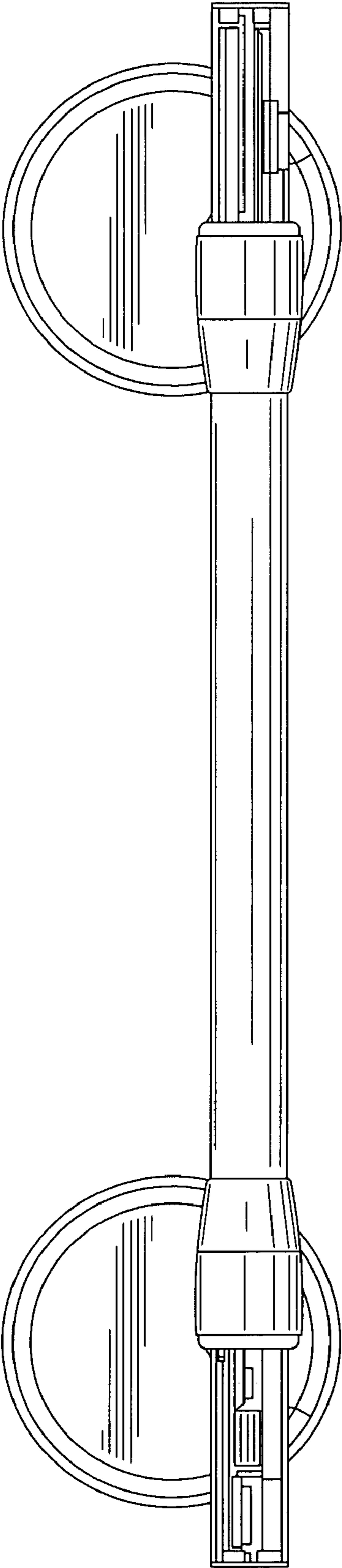

FIG. 1

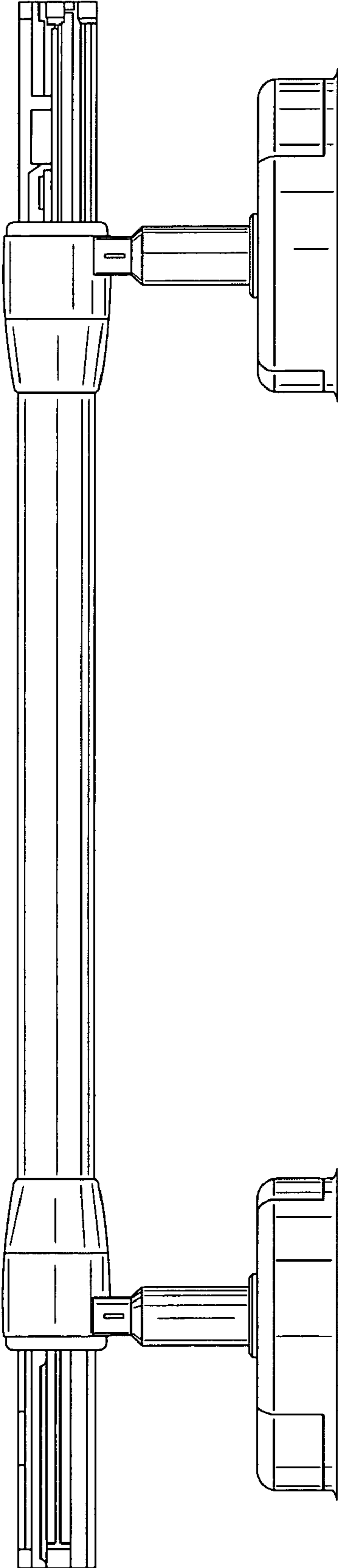

FIG. 2

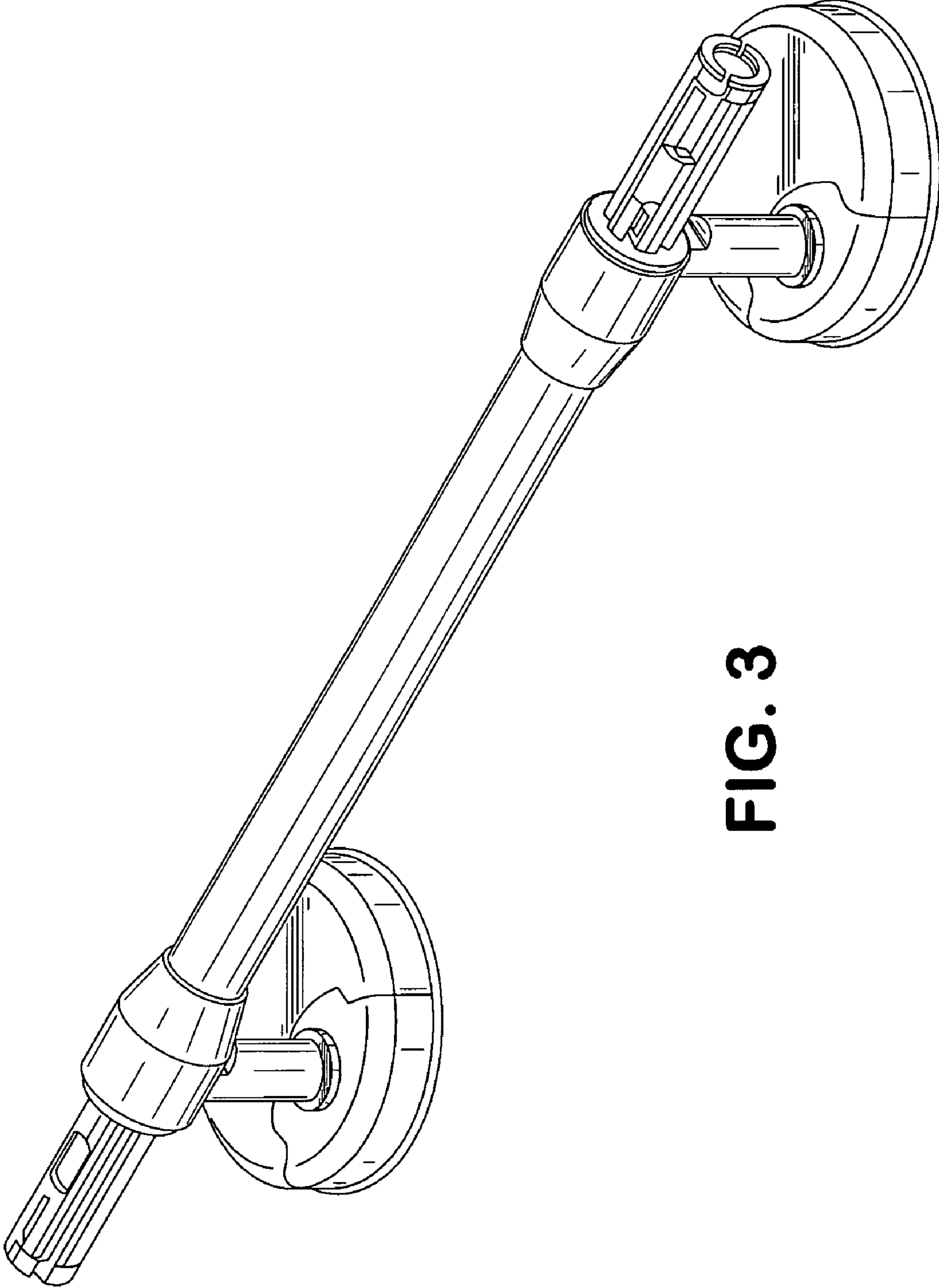

FIG. 3

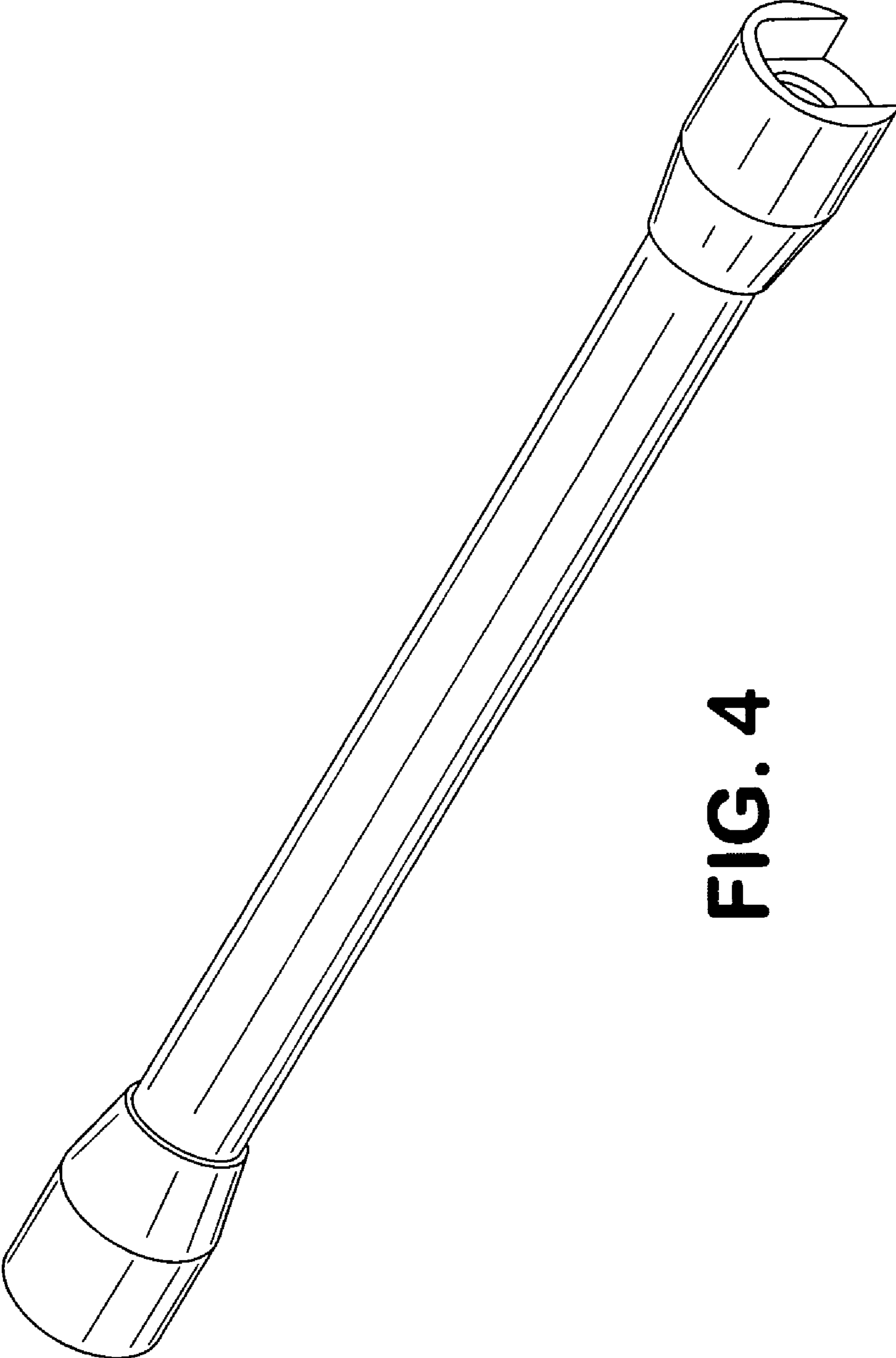

FIG. 4

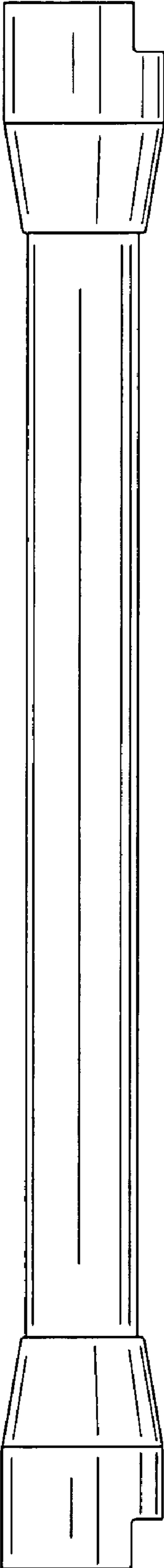

FIG. 5

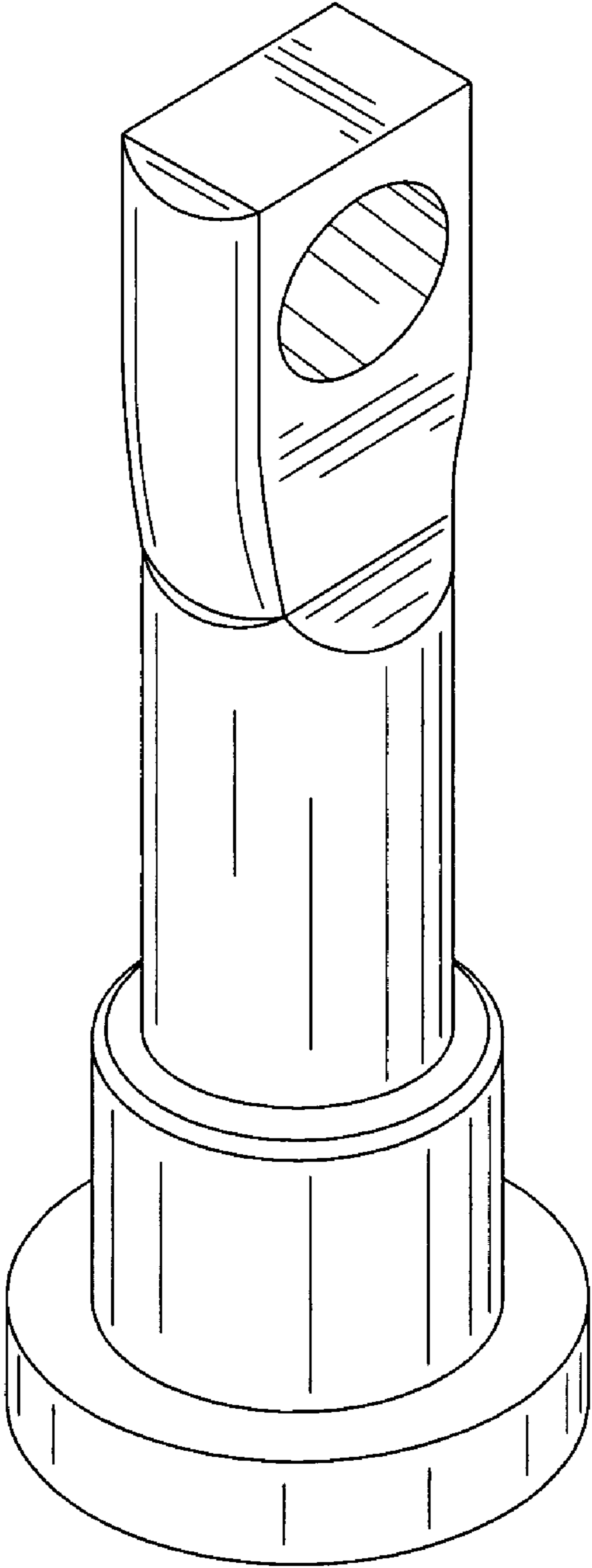

FIG. 6

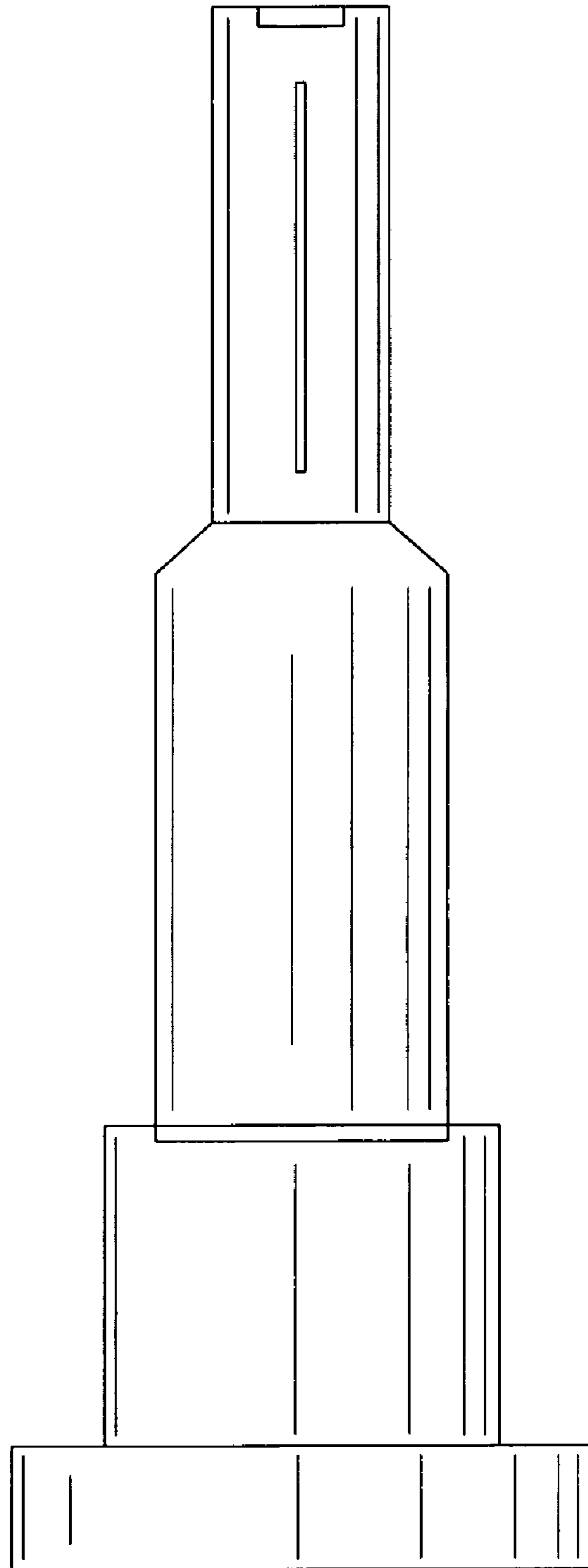

FIG. 7