



US00D584114S

(12) **United States Design Patent**
Mah et al.

(10) **Patent No.:** **US D584,114 S**
(45) **Date of Patent:** **** Jan. 6, 2009**

(54) **FOOD PROCESSOR**

D442,033 S * 5/2001 de Saint-Genois D7/673

(75) Inventors: **Pat Y. Mah**, Kowloon (HK); **Alexander Joseph Kalogroulis**, Coulsdon (GB)

* cited by examiner

(73) Assignee: **Daka Research Inc. (Br. Virg. Isl Corp.)**, Tortolla (VG)

Primary Examiner—Terry A Wallace
(74) *Attorney, Agent, or Firm*—Curtis L. Harrington; Kathy E. Harrington; Harrington & Harrington

(**) Term: **14 Years**

(57) **CLAIM**

(21) Appl. No.: **29/294,565**

The ornamental design for an food processor, as shown and described.

(22) Filed: **Jan. 16, 2008**

DESCRIPTION

(51) **LOC (9) Cl.** **07-04**

(52) **U.S. Cl.** **D7/672**

(58) **Field of Classification Search** D7/672–677,
D7/373, 374, 381, 384, 412; 83/651.1, 648;
30/278–291; 241/273.1–273.4, 93, 95, 168,
241/169, 101.1, 37.5, 36

FIG. 1 is a perspective view of the food processor, the storage blades and support shown in dashed line format and forming no part of the invention hereof;

FIG. 2 is a right side view;

FIG. 3 is a left side view;

FIG. 4 is a rear view;

FIG. 5 is a front view;

FIG. 6 is a top view; and,

FIG. 7 is a bottom view.

See application file for complete search history.

(56) **References Cited**

U.S. PATENT DOCUMENTS

- D320,717 S * 10/1991 O'Brien D7/384
- D368,622 S * 4/1996 Izumi D7/384
- D420,547 S * 2/2000 Lallemand D7/384

1 Claim, 6 Drawing Sheets

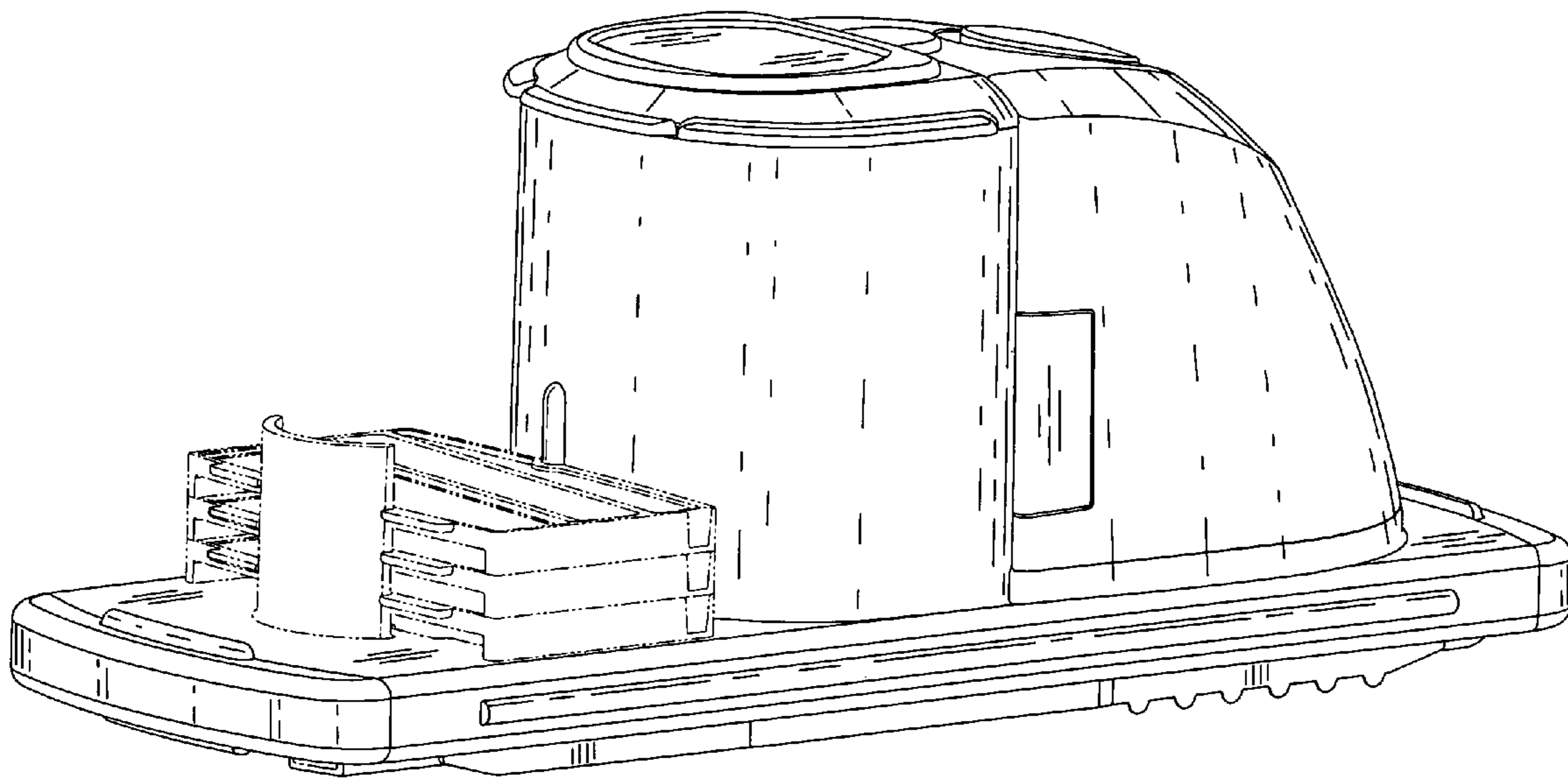

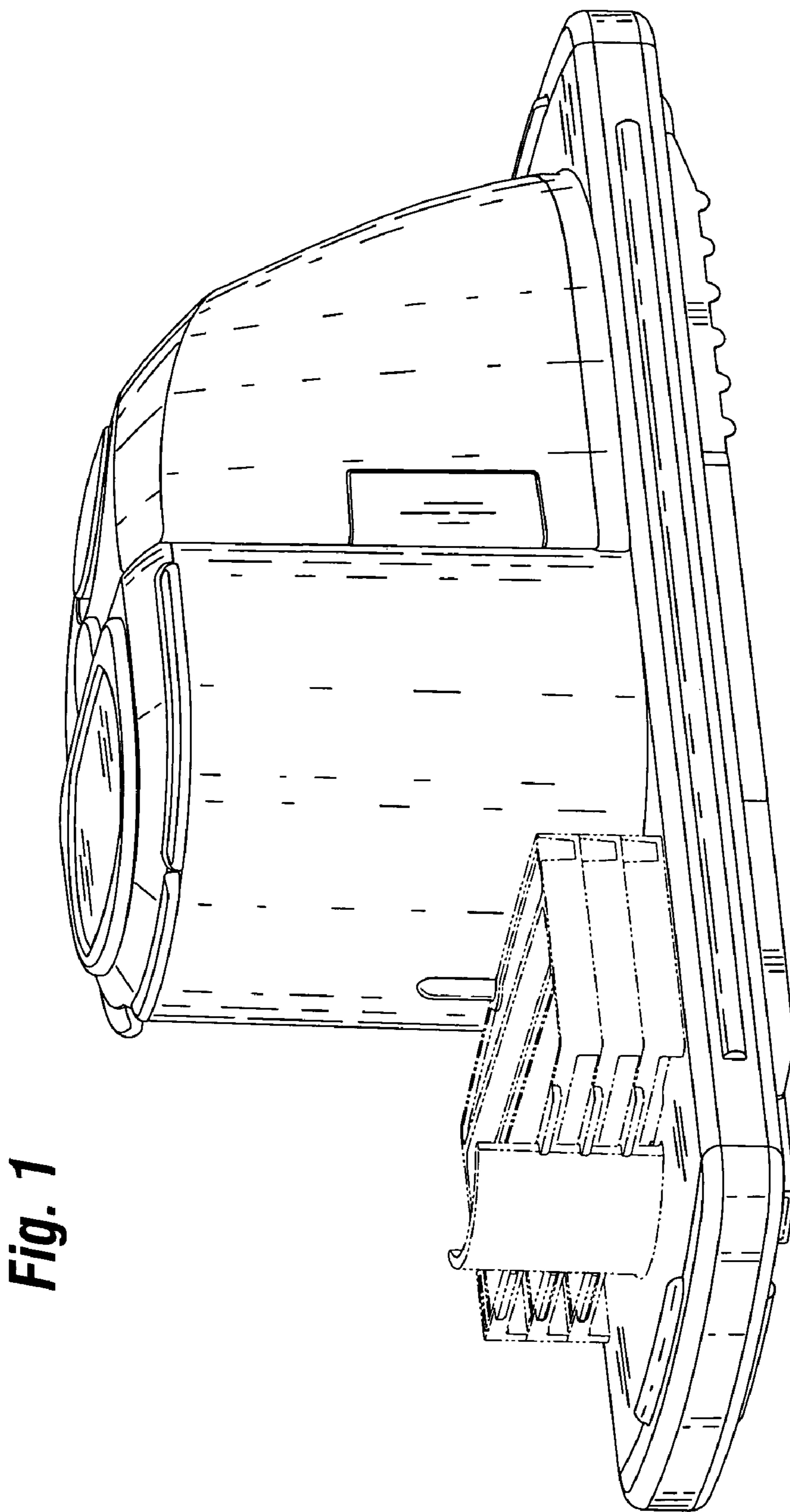
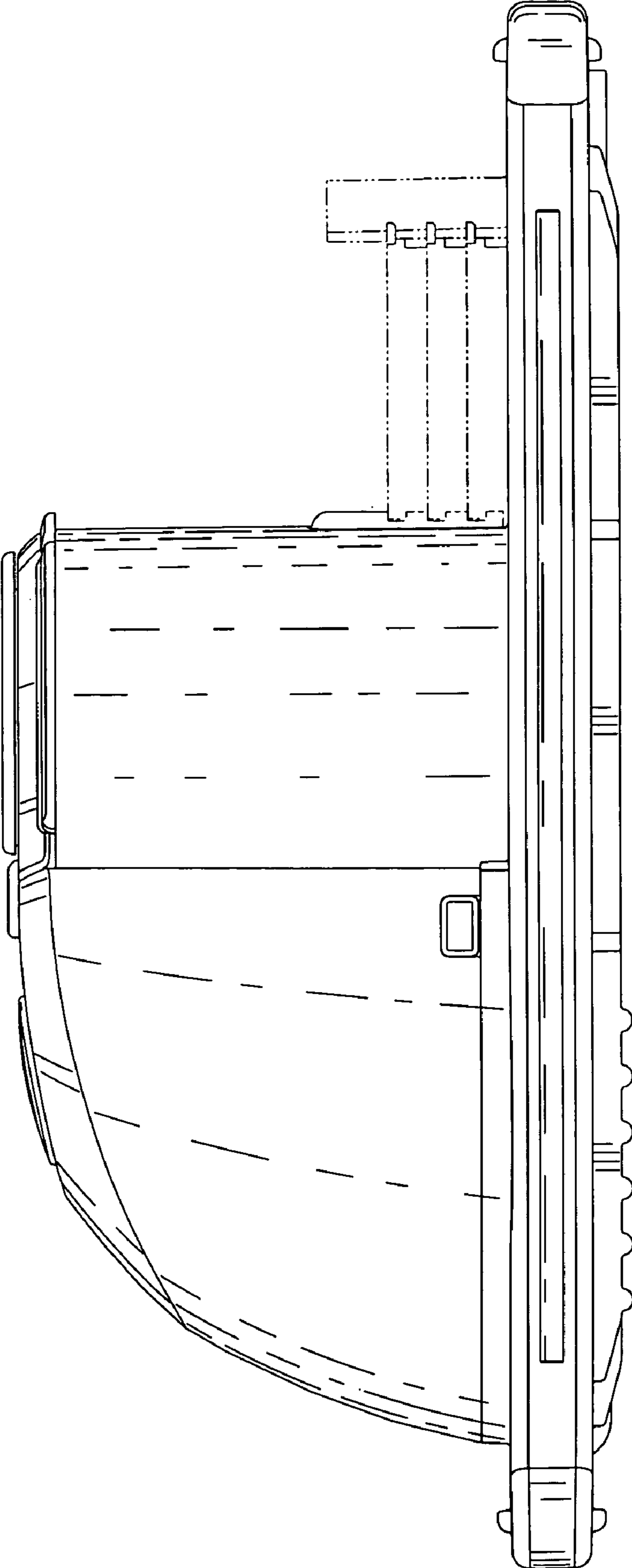

Fig. 1

Fig. 2



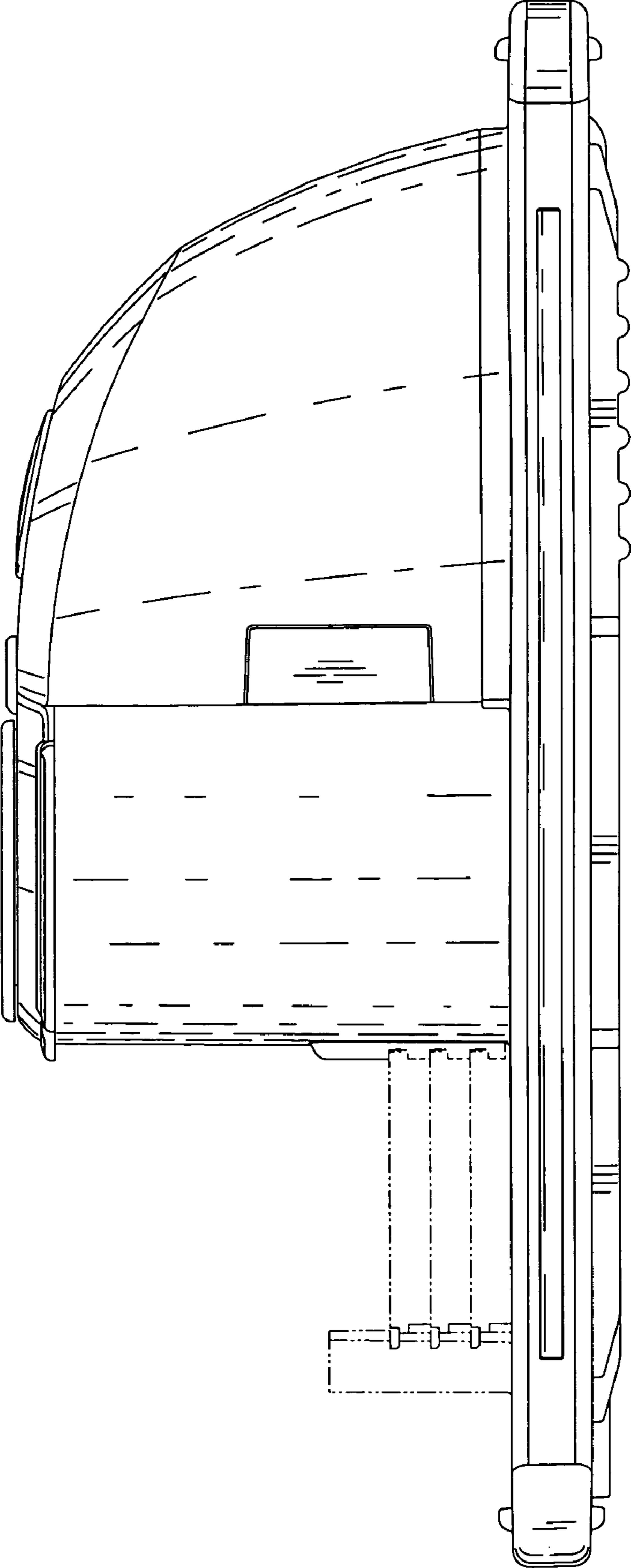

Fig. 3

Fig. 4

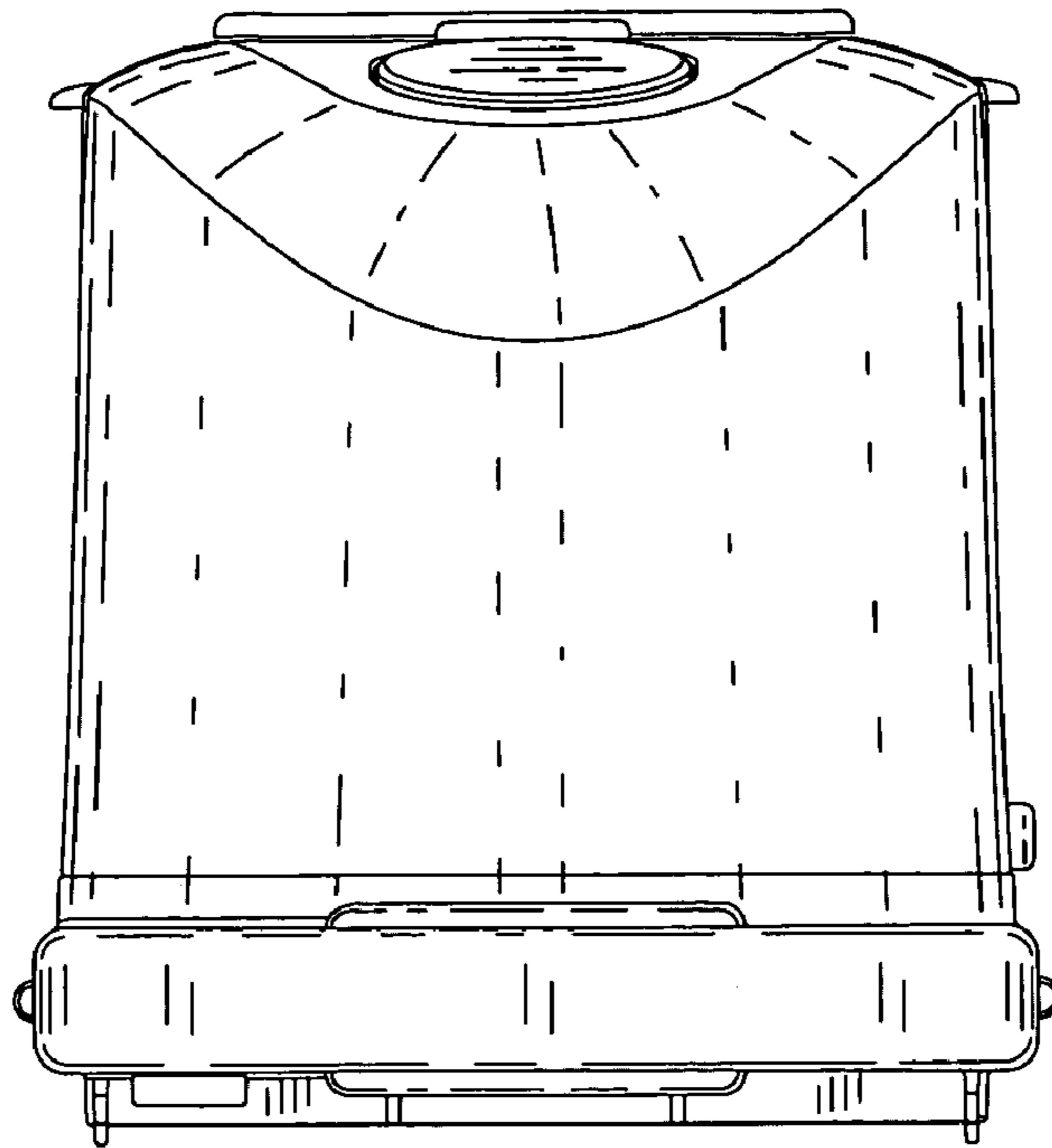

Fig. 5

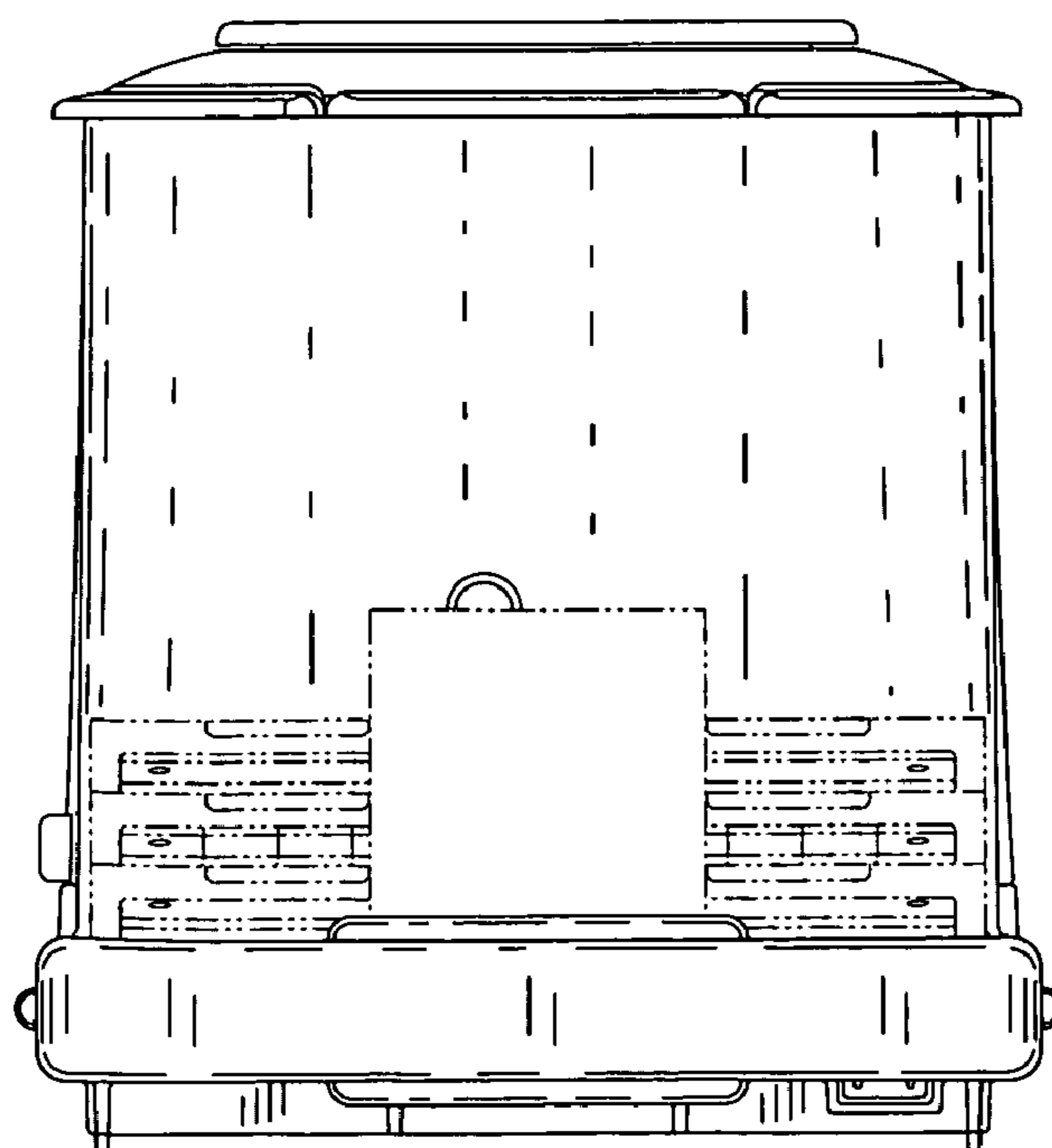

Fig. 6

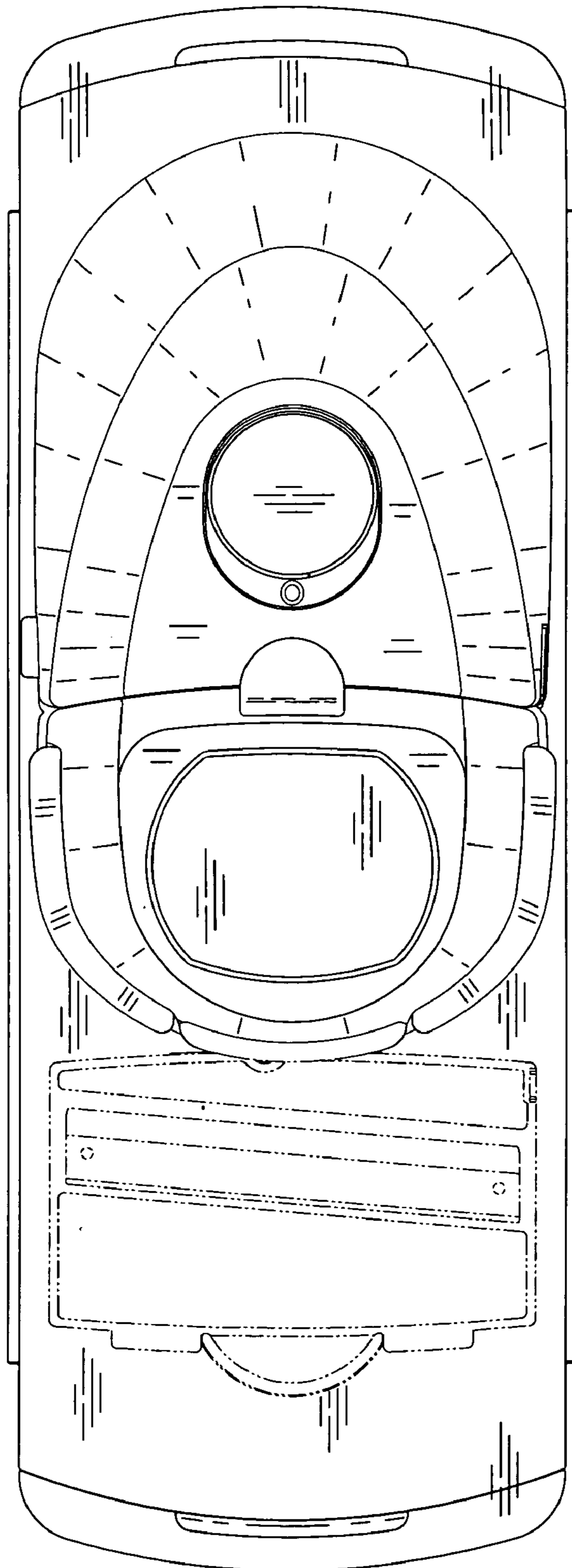

Fig. 7

