



US00D584082S

(12) **United States Design Patent**
Nguyen

(10) **Patent No.:** **US D584,082 S**
(45) **Date of Patent:** **** Jan. 6, 2009**

(54) **BACK REST FOR A CHAIR**

D472,065 S * 3/2003 Tseng D6/366
D494,390 S * 8/2004 True D6/500

(75) Inventor: **Lee Nguyen**, Norwalk, CA (US)

* cited by examiner

(73) Assignee: **True Seating Concepts, LLC** (MU)

Primary Examiner—Mimosa De

(**) Term: **14 Years**

(74) *Attorney, Agent, or Firm*—Morland C. Fischer

(21) Appl. No.: **29/308,147**

(57) **CLAIM**

(22) Filed: **Jun. 2, 2008**

The ornamental design for a back rest for a chair, as shown and described.

(51) **LOC (9) Cl.** **06-01**

(52) **U.S. Cl.** **D6/502; D6/366**

(58) **Field of Classification Search** D6/334–336,
D6/356, 360, 364, 366, 372, 374, 375, 379,
D6/380, 500–502; 297/452.26, 452.29, 452.32,
297/452.33, 452.37, 452.48

See application file for complete search history.

DESCRIPTION

FIG. 1 is a perspective view showing the top, left side and front of a back rest for a chair which forms my new design, the broken lines of other parts of the chair in this and other figures being for illustrative purposes only and forming no part of my design;

(56) **References Cited**

U.S. PATENT DOCUMENTS

D233,921 S * 12/1974 Barecki D6/356
D257,748 S * 1/1981 Smith D6/356
D409,405 S * 5/1999 Schultz et al. D6/372
D451,316 S * 12/2001 Tseng D6/500

FIG. 2 is a front elevational view thereof;

FIG. 3 is a left side elevational view thereof;

FIG. 4 is a right side elevational view thereof; and,

FIG. 5 is a top plan view thereof.

1 Claim, 5 Drawing Sheets

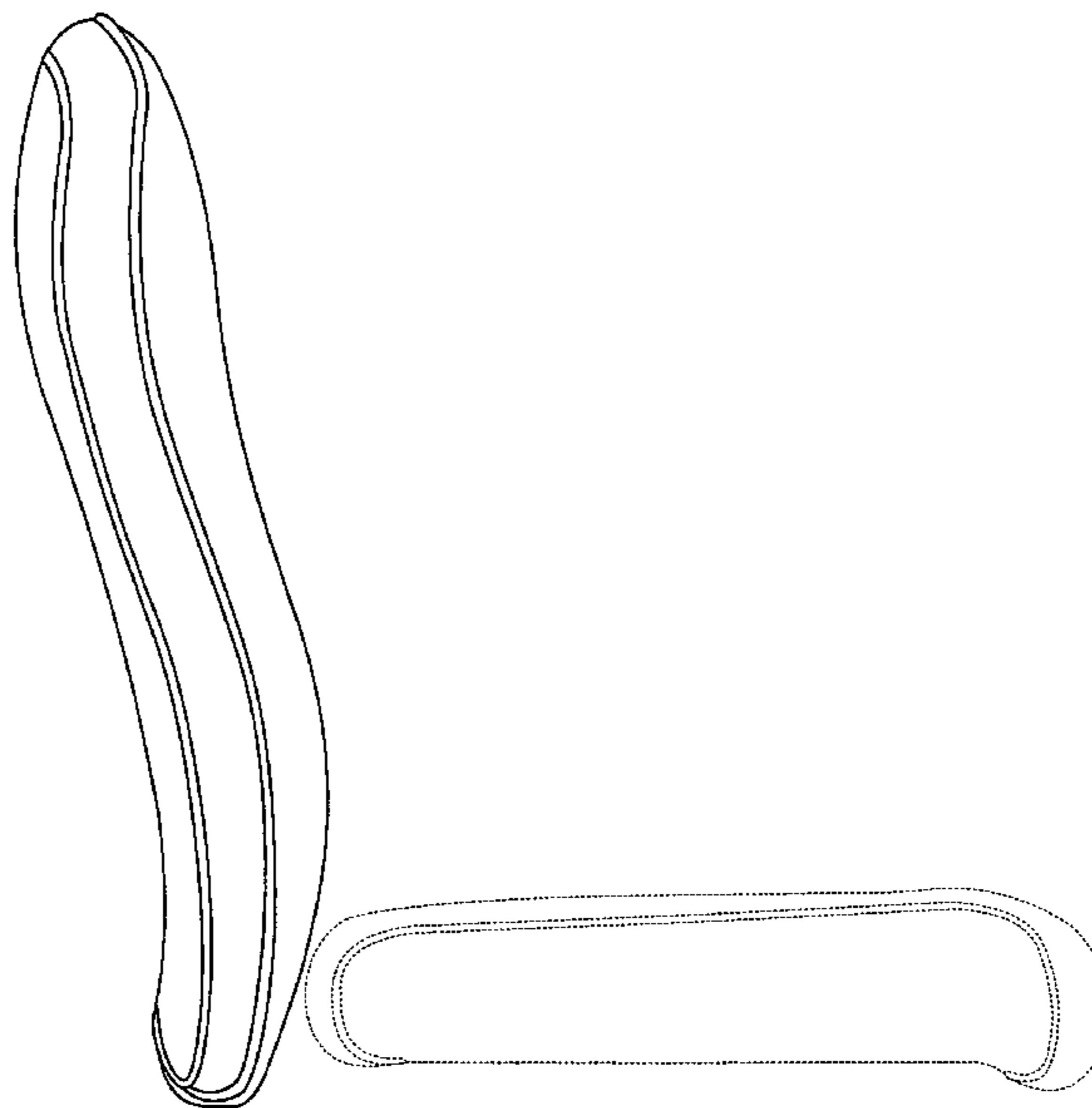
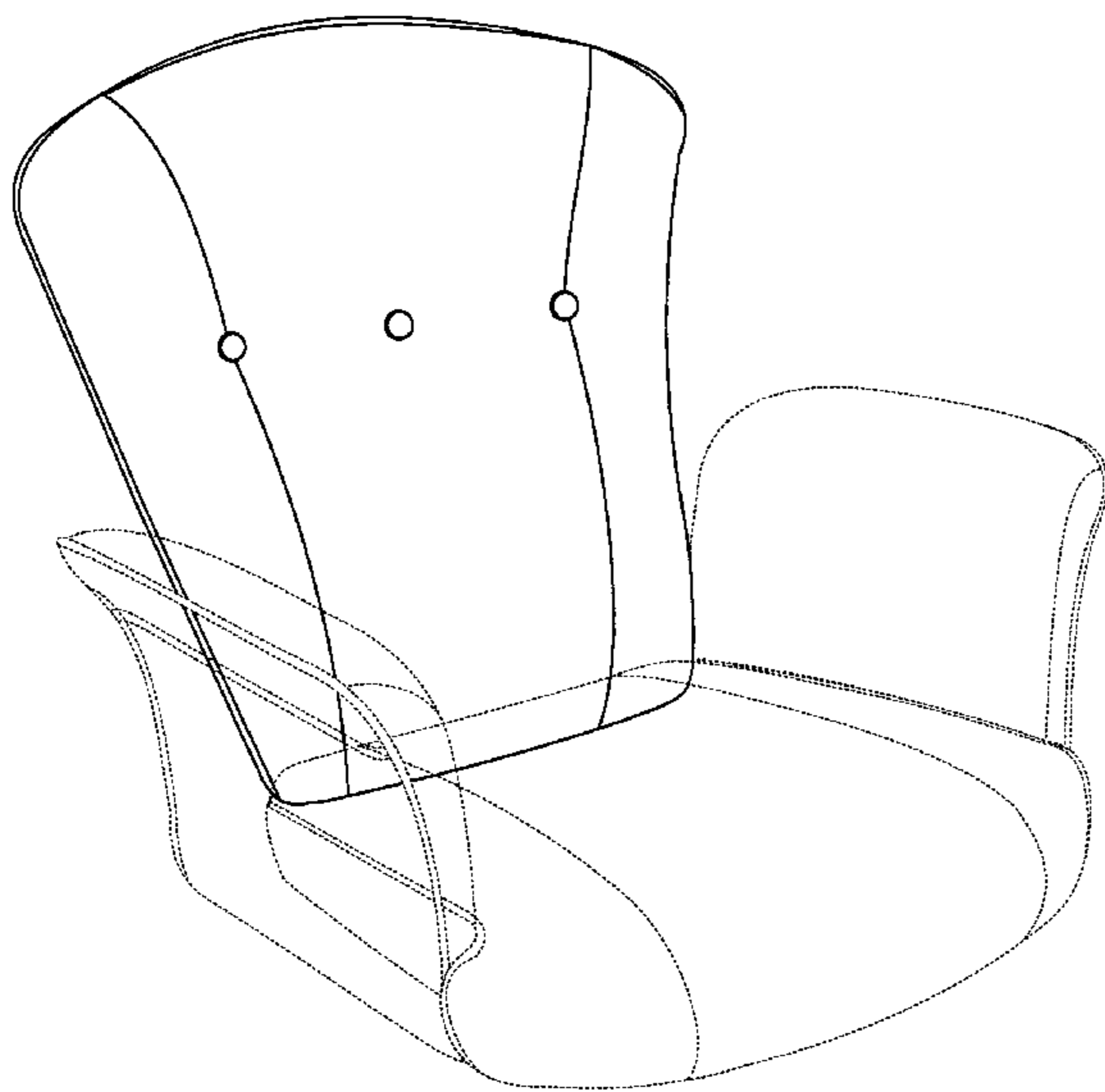

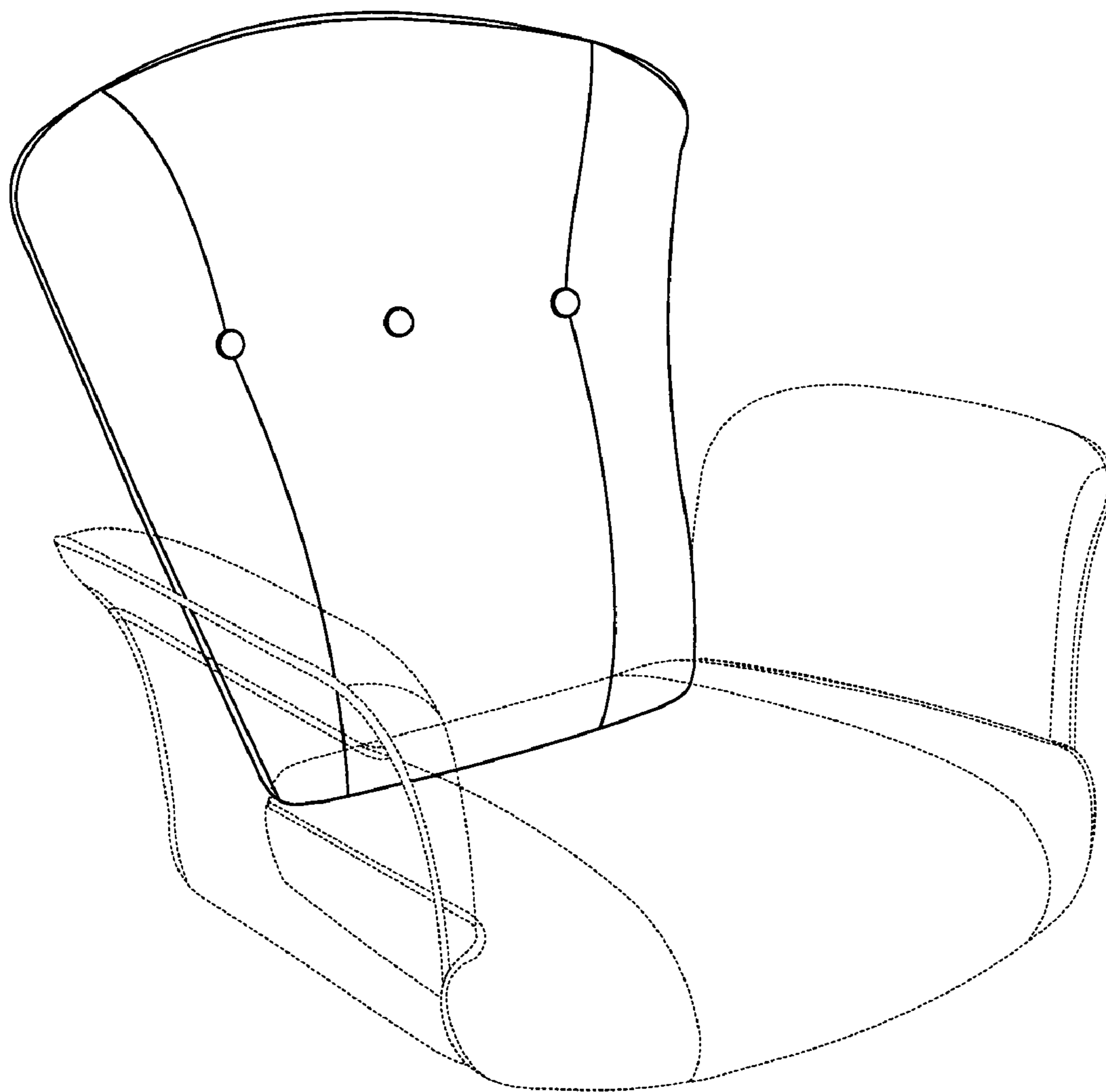

FIG. 1

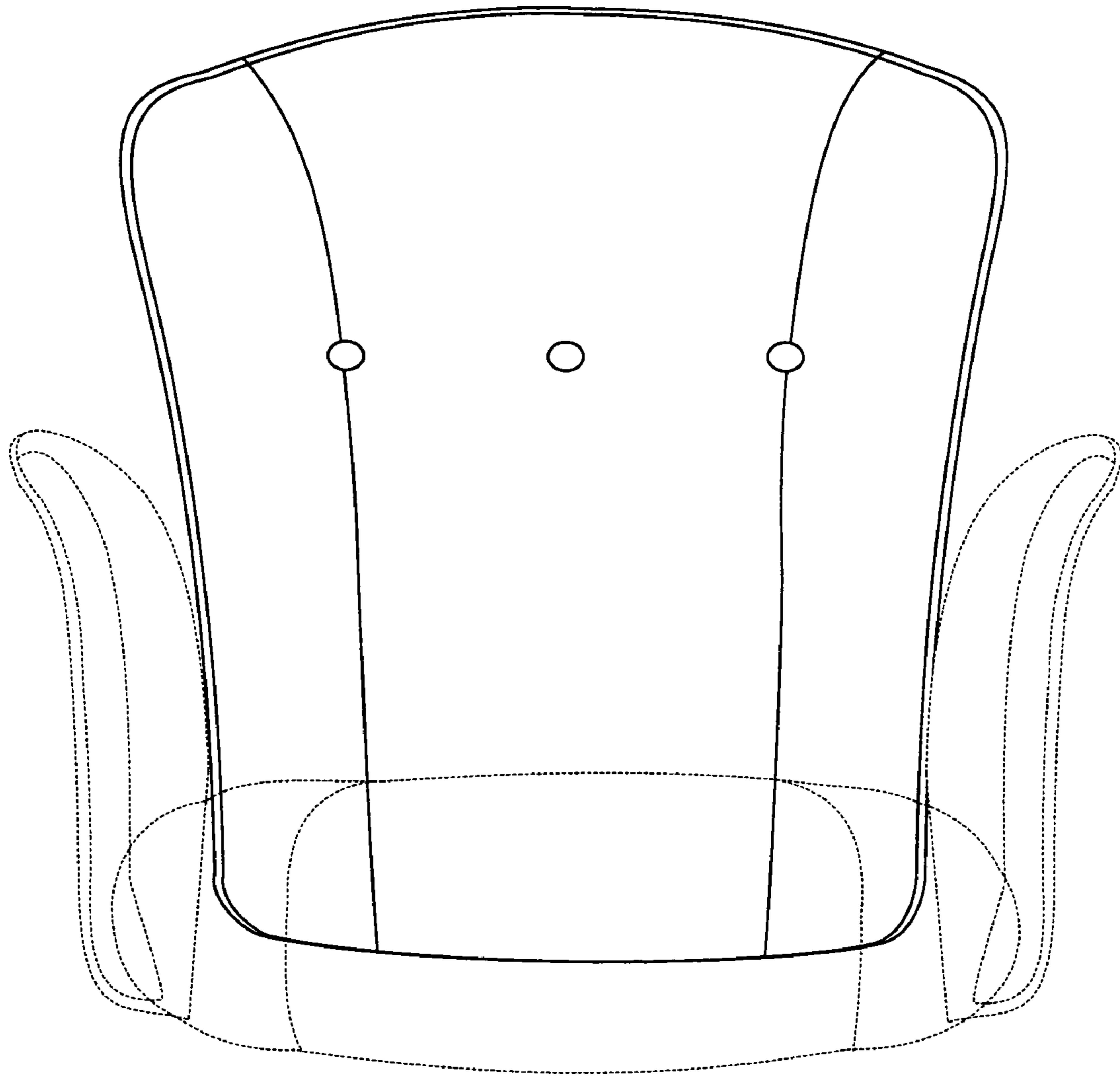

FIG. 2

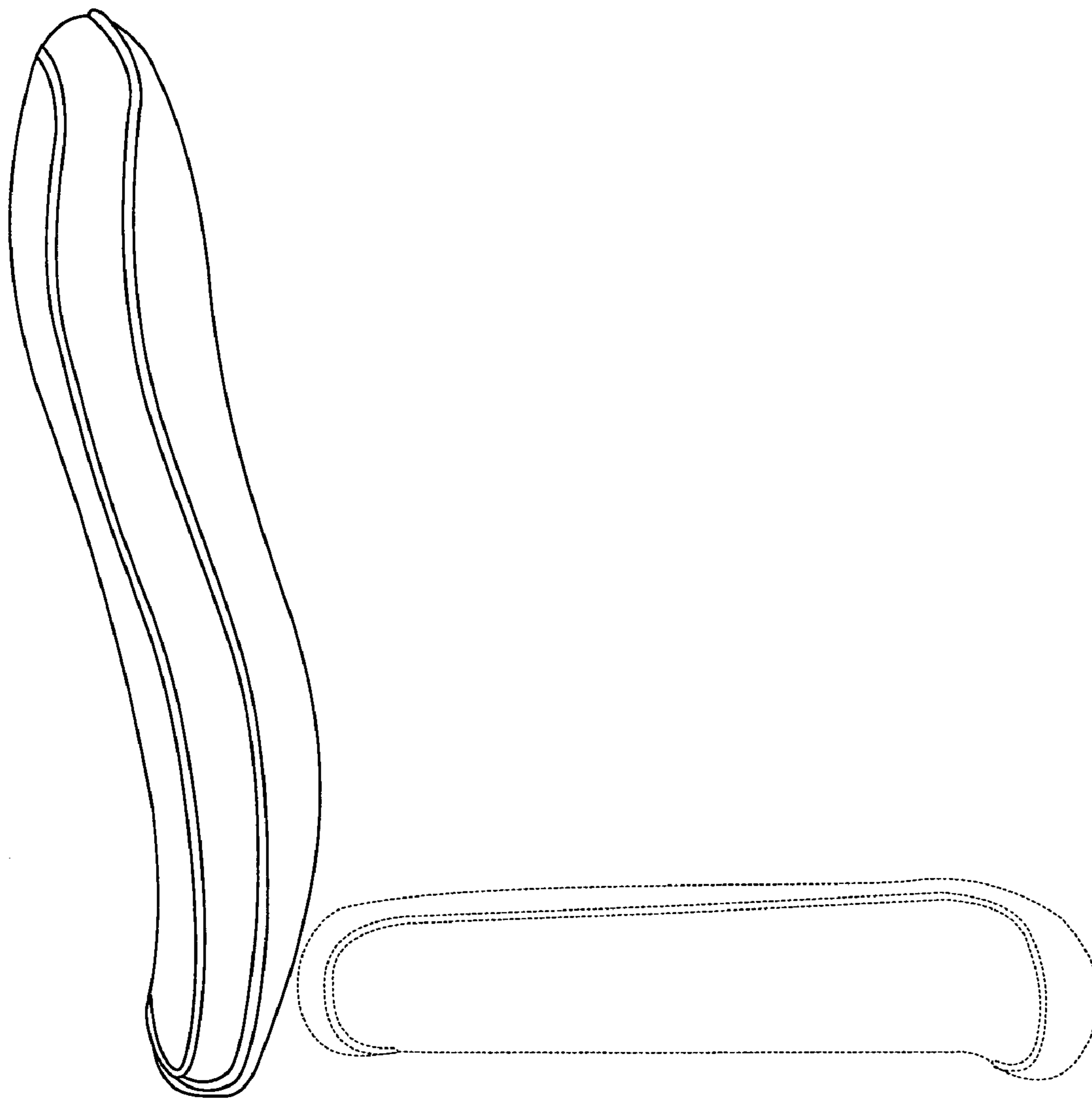

FIG. 3

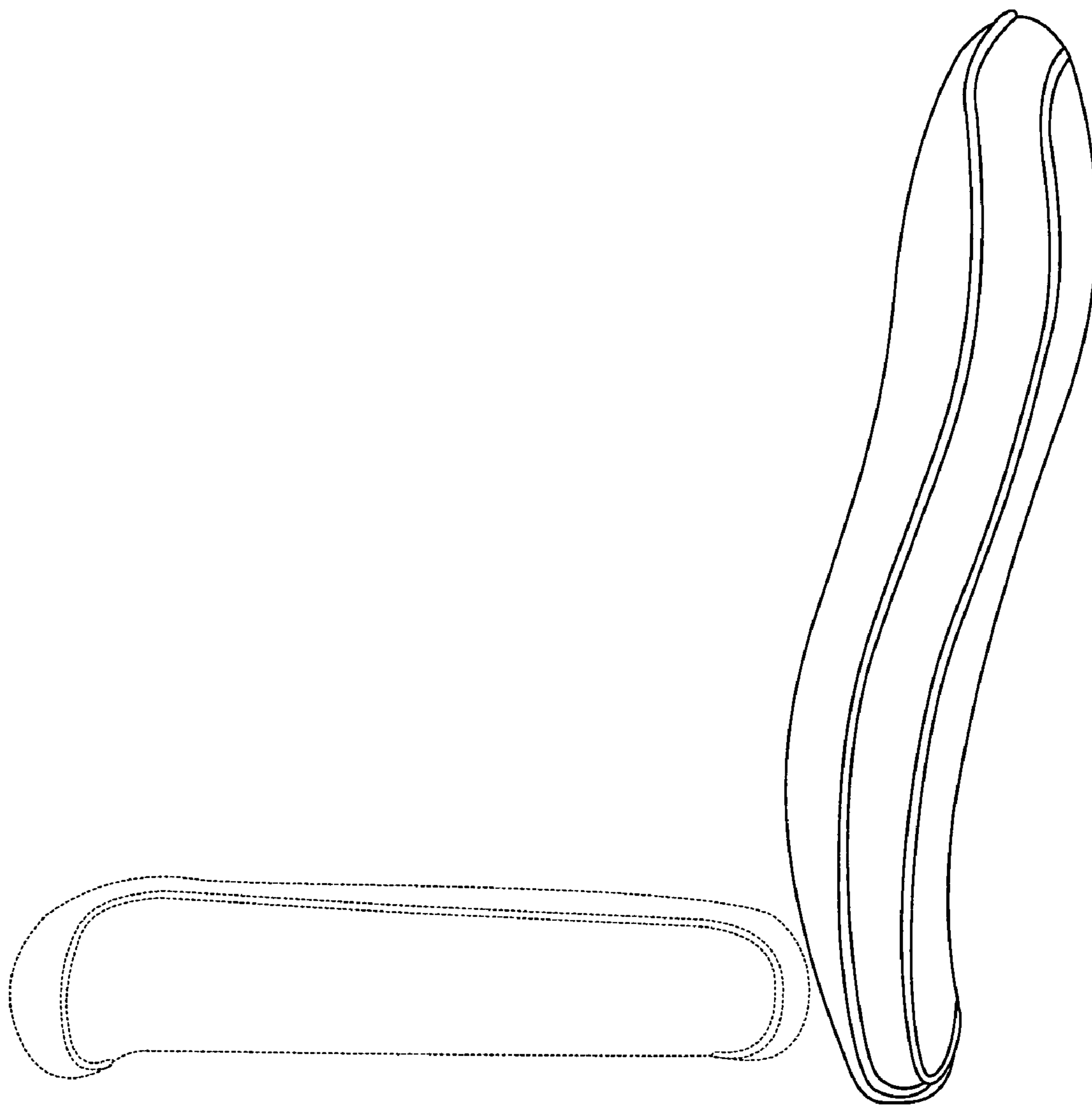

FIG. 4

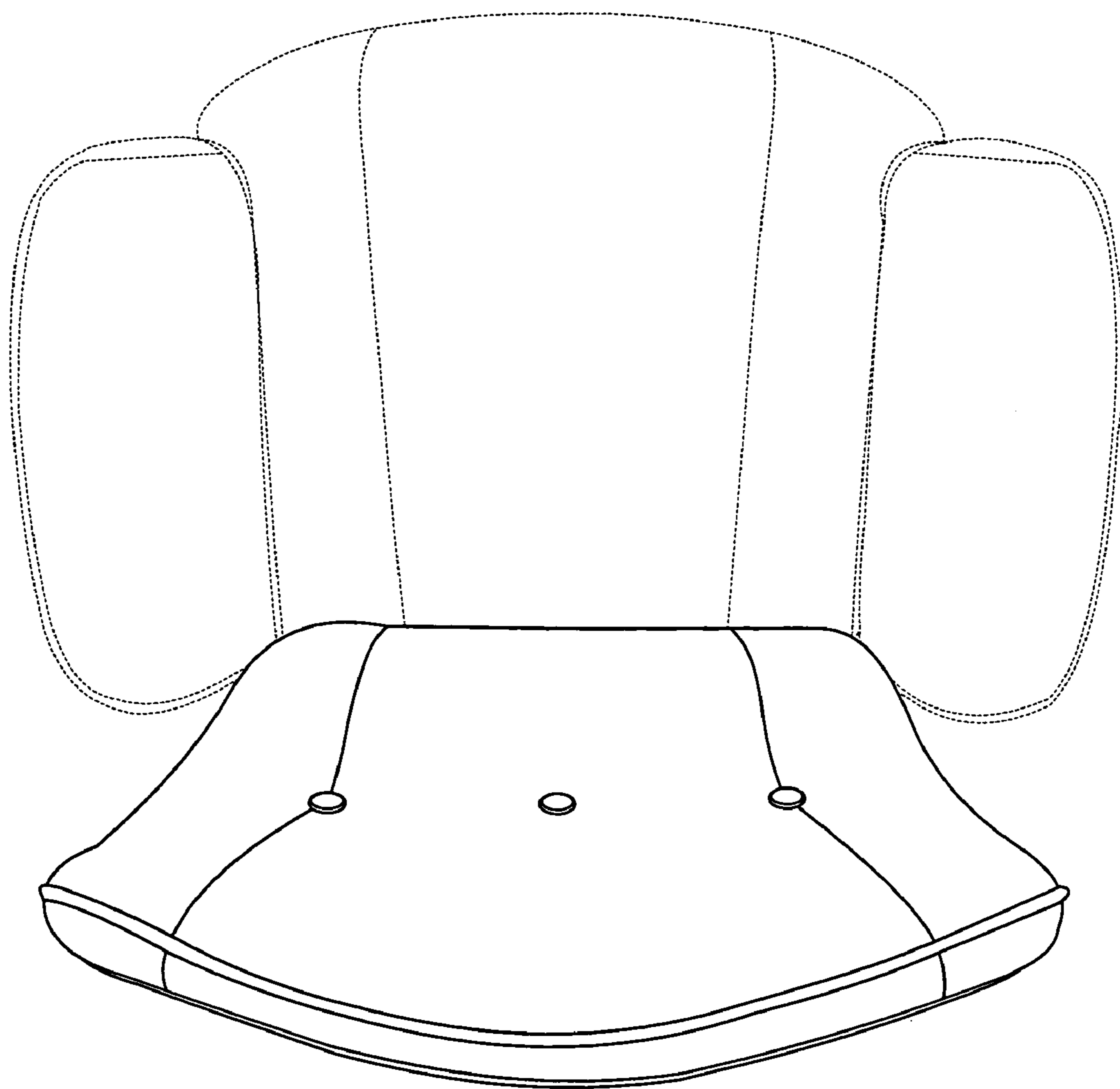

FIG. 5