



US00D584058S

(12) **United States Design Patent Grant**

(10) **Patent No.:** **US D584,058 S**  
(45) **Date of Patent:** **\*\* Jan. 6, 2009**

(54) **APPLICATOR DEVICE**

(75) Inventor: **Bradford Grant**, Bridgewater, NJ (US)

(73) Assignee: **McNeil-PPC, Inc.**, Skillman, NJ (US)

(\*\*) Term: **14 Years**

(21) Appl. No.: **29/258,551**

(22) Filed: **Apr. 24, 2006**

**Related U.S. Application Data**

(63) Continuation of application No. 29/242,268, filed on Nov. 8, 2005, now abandoned, which is a continuation of application No. 29/230,168, filed on May 18, 2005, now abandoned, which is a continuation of application No. 29/203,612, filed on Apr. 16, 2004, now abandoned.

(51) **LOC (9) Cl.** ..... **04-02**

(52) **U.S. Cl.** ..... **D4/108; D4/136**

(58) **Field of Classification Search** ..... D4/104–114, D4/134, 136, 138; D9/718, 723, 724; D24/146, D24/147, 211, 214; D28/7, 20, 23, 63; 15/110, 15/143.1, 167.1, 167.2, 188, 207.2, DIG. 5; 132/308, 311; 401/28, 143, 145, 149, 152, 401/156–158, 162, 183, 184, 186, 268, 270, 401/271, 278, 279, 282, 284, 286, 291; 601/139, 601/141

See application file for complete search history.

(56) **References Cited**

**U.S. PATENT DOCUMENTS**

D116,162 S \* 8/1939 Hall ..... D4/136  
2,321,265 A \* 6/1943 Ulvick ..... 401/184 X  
3,938,897 A \* 2/1976 Craig ..... 401/286 X

4,454,623 A \* 6/1984 O'Halloran ..... 15/167.1  
D301,401 S \* 6/1989 Berendsen et al. .... D4/108  
5,398,367 A \* 3/1995 Lu ..... 15/167.1  
5,403,105 A \* 4/1995 Jameson ..... 401/291 X  
D357,809 S \* 5/1995 Brown et al. .... D4/113  
D373,250 S \* 9/1996 Cavazza ..... D4/104  
D388,254 S \* 12/1997 Schiffer ..... D4/107  
D495,803 S \* 9/2004 Gough et al. .... D24/211

\* cited by examiner

*Primary Examiner*—Cathron C Brooks

*Assistant Examiner*—Lavone D Tabor

(57) **CLAIM**

I claim the ornamental design for an applicator device, as shown and described.

**DESCRIPTION**

FIG. 1 is a front perspective view of an applicator device;

FIG. 2 is a side elevation view of the applicator device shown in FIG. 1;

FIG. 3 is a front elevation view of the applicator device shown in FIG. 1;

FIG. 4 is a rear elevation view of the applicator device shown in FIG. 1;

FIG. 5 is a top view of the applicator device shown in FIG. 1; and,

FIG. 6 is a bottom view of the applicator device taken along line 6—6 of FIG. 2.

The ornamental design which is claimed is shown in solid lines in the drawings. The broken lines immediately adjacent the shaded areas represent the bounds of the claim and all of the other broken lines are for illustrative purposes only. None of the broken lines form a part of the claimed design.

**1 Claim, 3 Drawing Sheets**

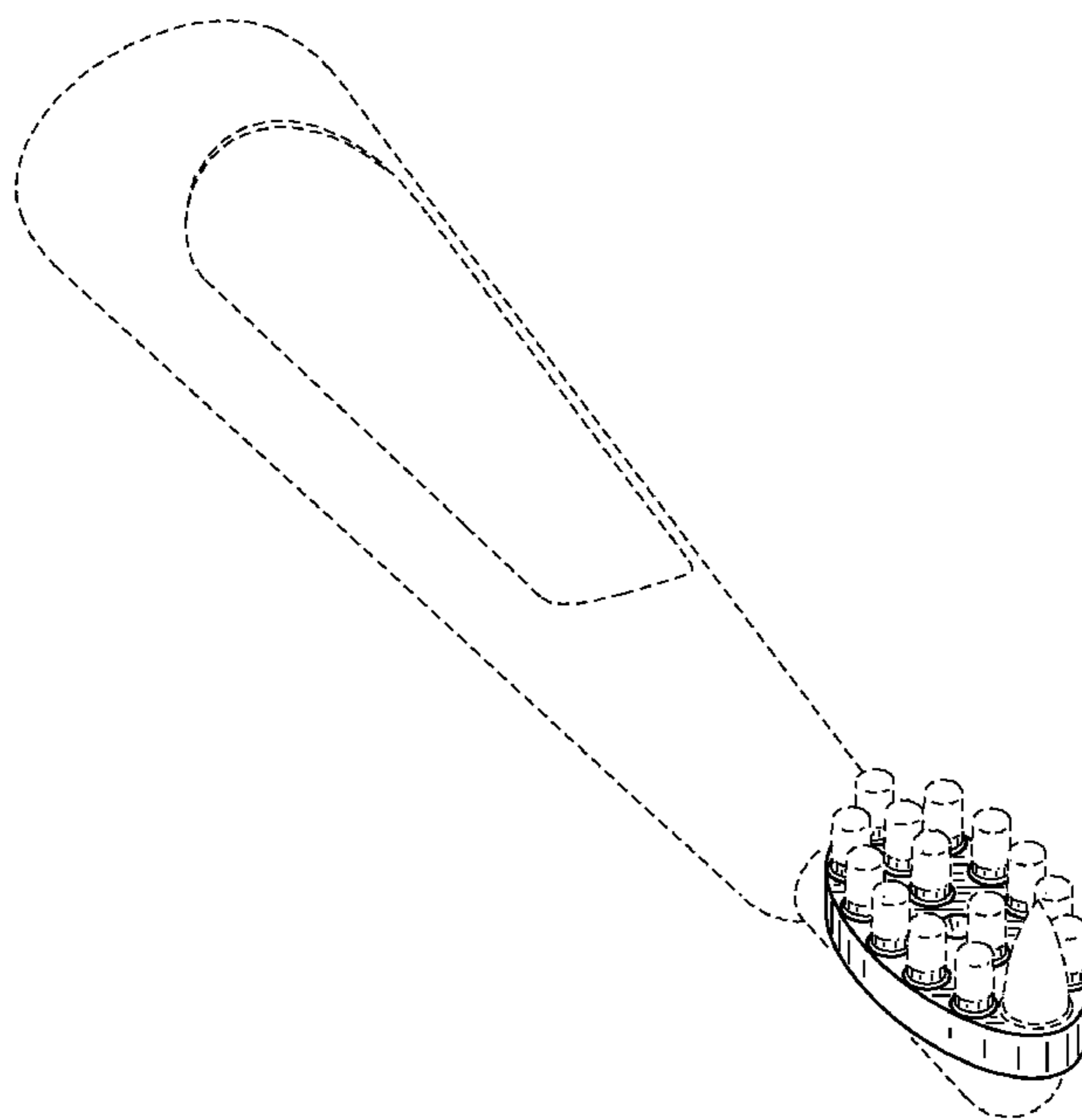

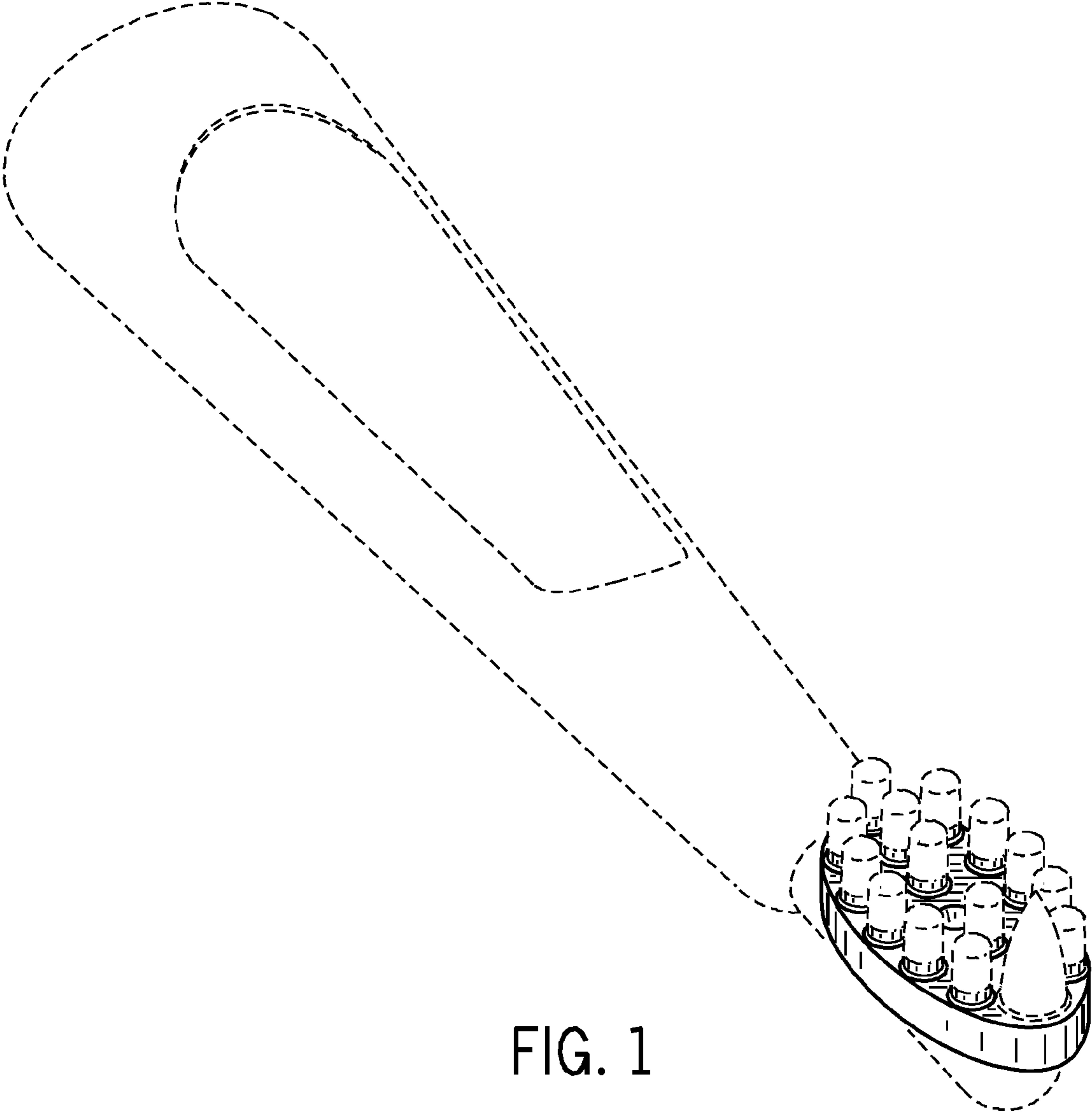

FIG. 1

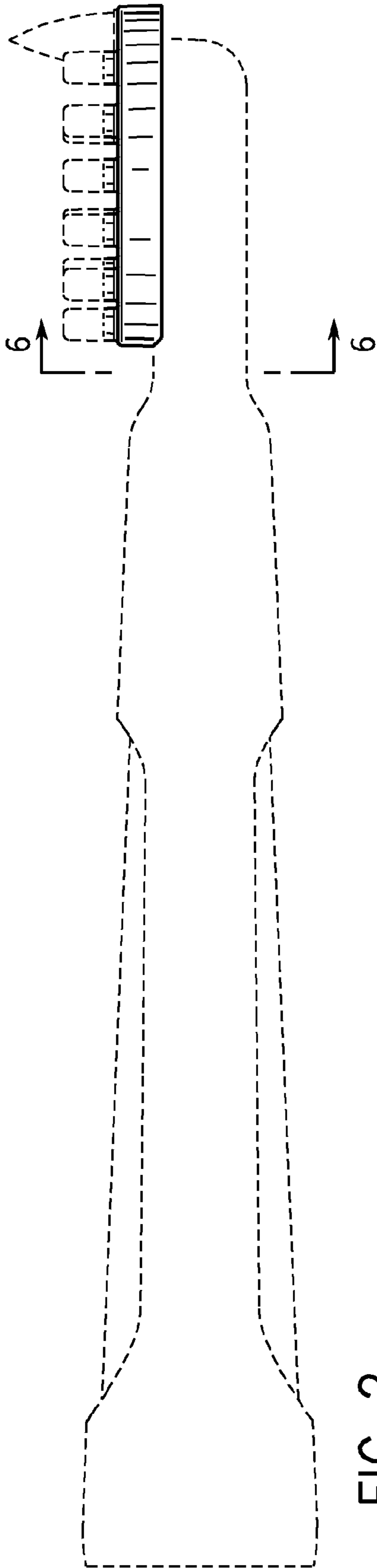

FIG. 2

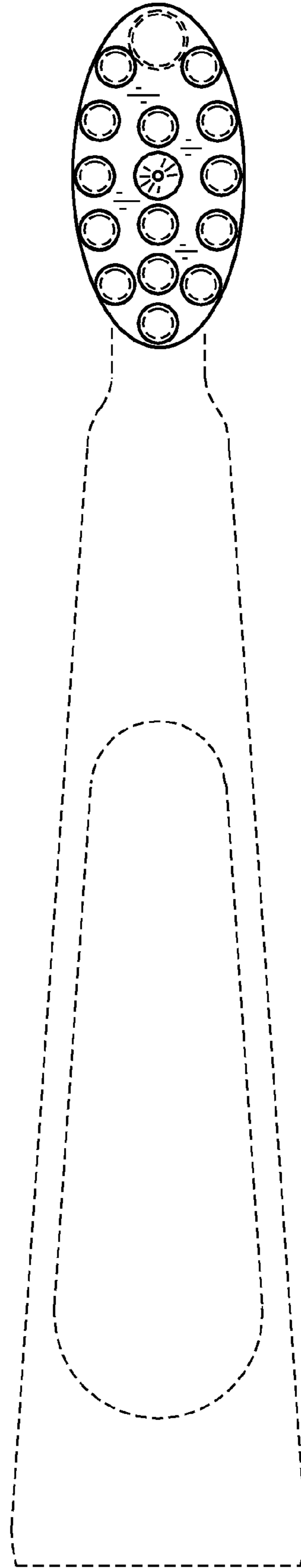

FIG. 3

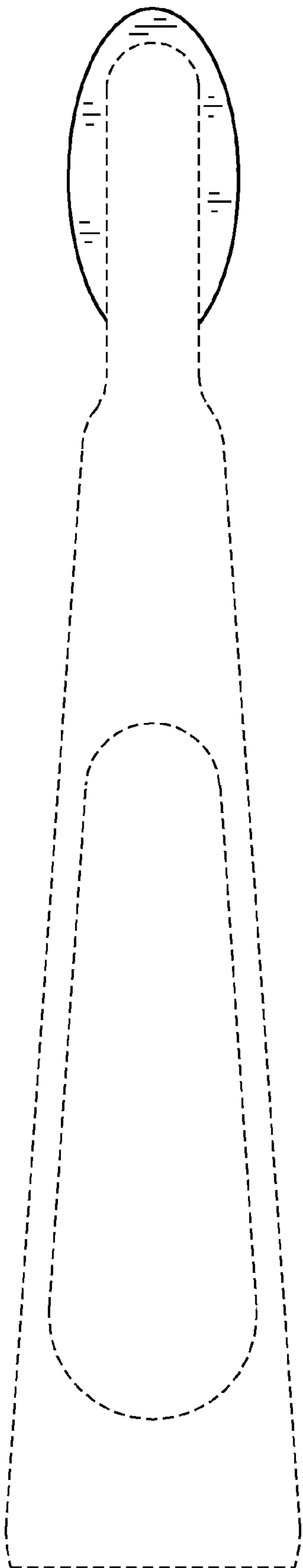

FIG. 4

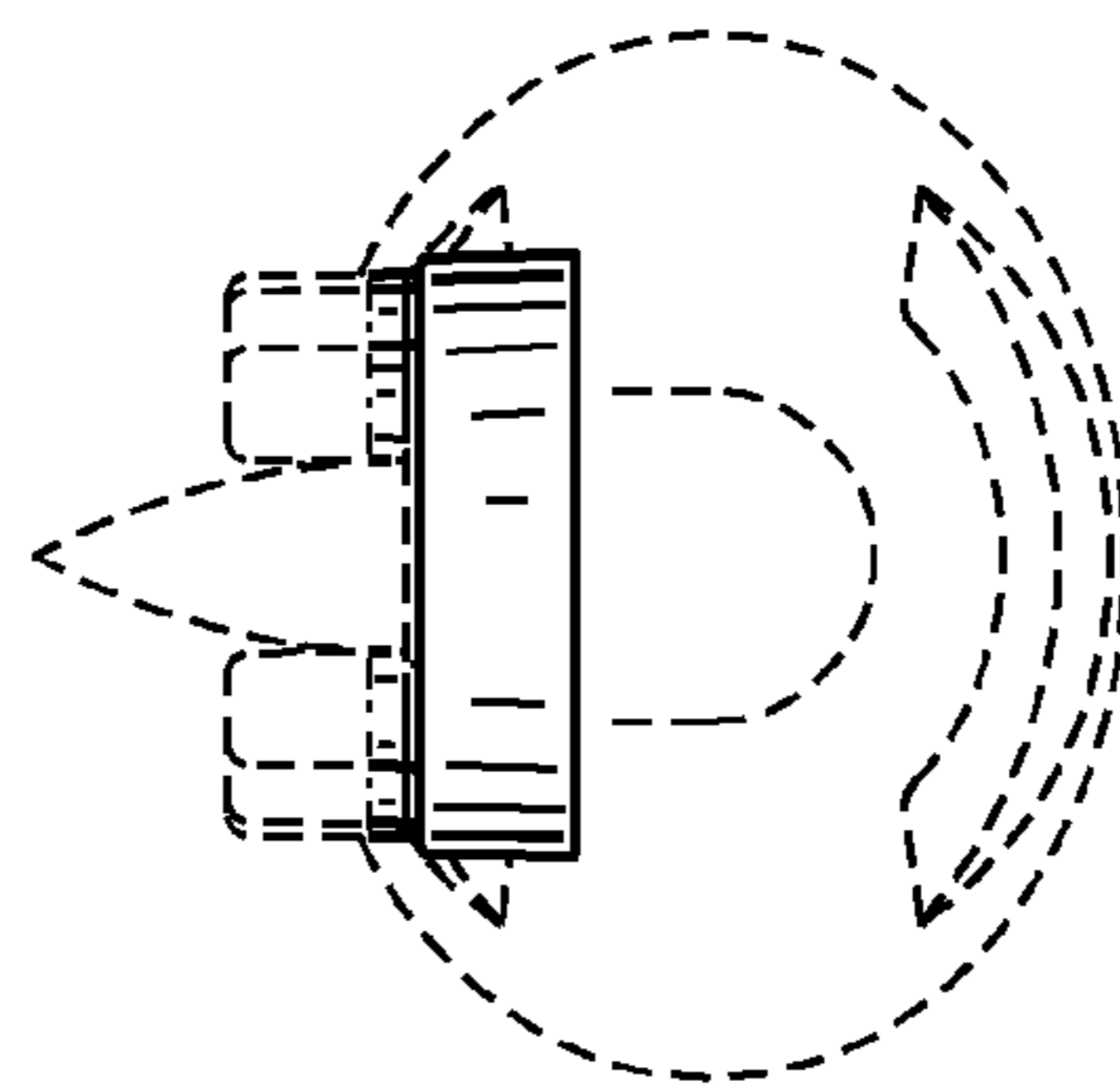

FIG. 5

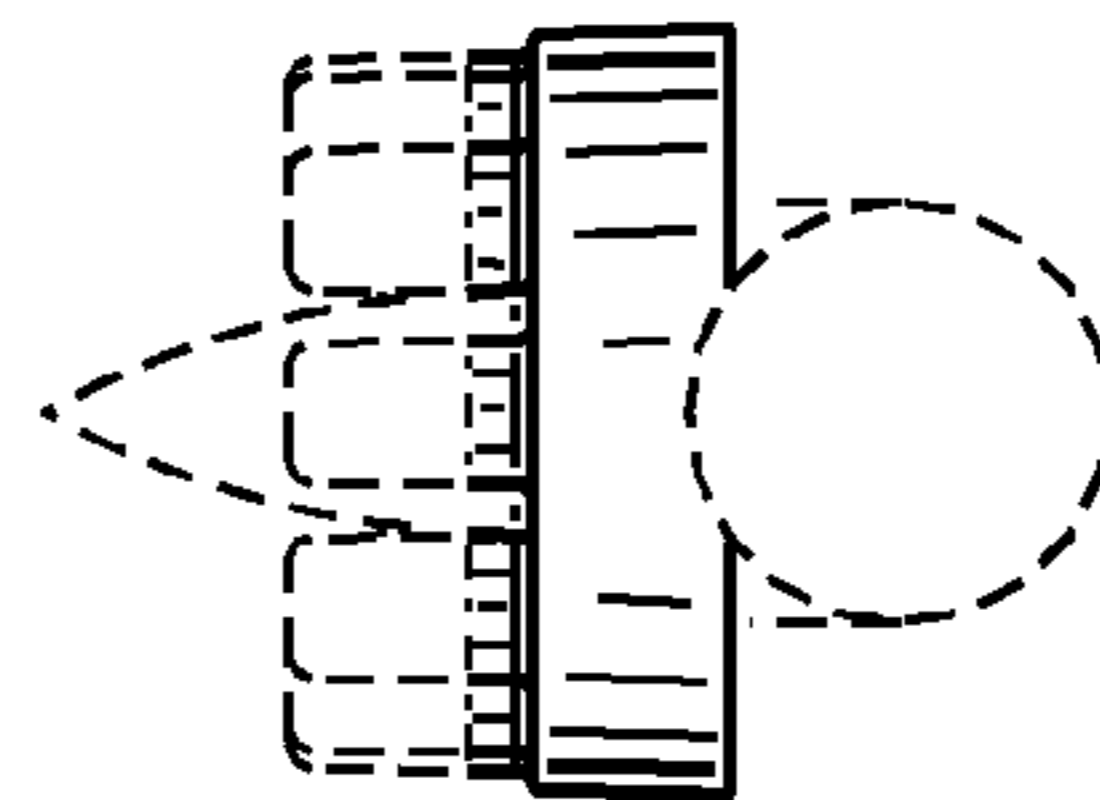

FIG. 6