



US00D583786S

(12) **United States Design Patent**  
**Jeong et al.**

(10) **Patent No.:** **US D583,786 S**  
(45) **Date of Patent:** **\*\* Dec. 30, 2008**

(54) **MOBILE PHONE**

(75) Inventors: **Jong Il Jeong**, Seoul (KR); **Sang Min Hyun**, Seoul (KR); **Hyoung Shin Park**, Seoul (KR)

(73) Assignee: **Samsung Electronics Co., Ltd.**, Suwon, Kyungki-Do (KR)

(\*\*) Term: **14 Years**

(21) Appl. No.: **29/288,593**

(22) Filed: **Jun. 15, 2007**

(51) **LOC (8) Cl.** ..... **14-03**

(52) **U.S. Cl.** ..... **D14/138 AB; D14/138 AB**

(58) **Field of Classification Search** ..... D14/138,  
D14/496, 341-347; 455/575.3, 575.1  
See application file for complete search history.

(56) **References Cited**

**U.S. PATENT DOCUMENTS**

D486,461 S *	2/2004	Seo et al.	.....	D14/138
D489,344 S *	5/2004	Lee et al.	.....	D14/138
D506,452 S *	6/2005	Lim	.....	D14/138
D508,684 S *	8/2005	Lee et al.	.....	D14/138
D512,039 S *	11/2005	Kim et al.	.....	D14/138
D512,394 S *	12/2005	Kim et al.	.....	D14/138
D512,398 S *	12/2005	Chen et al.	.....	D14/138
D518,809 S *	4/2006	Cho	.....	D14/138
D535,633 S *	1/2007	Cho	.....	D14/138
D535,965 S *	1/2007	Baik et al.	.....	D14/138
D536,323 S *	2/2007	Oh et al.	.....	D14/138
D549,199 S *	8/2007	Sugiura	.....	D14/138
D556,718 S *	12/2007	Jung et al.	.....	D14/138
D557,230 S *	12/2007	Kim et al.	.....	D14/138
D558,169 S *	12/2007	Chung et al.	.....	D14/138
D558,711 S *	1/2008	Moon et al.	.....	D14/138
D560,198 S *	1/2008	Kim et al.	.....	D14/138
D561,152 S *	2/2008	Kim et al.	.....	D14/138
D561,718 S *	2/2008	Kim et al.	.....	D14/138
D563,348 S *	3/2008	Park et al.	.....	D14/138
D563,927 S *	3/2008	Kim et al.	.....	D14/138
D564,481 S *	3/2008	Su	.....	D14/138
D564,487 S *	3/2008	Kim et al.	.....	D14/138

D565,014 S *	3/2008	Kim et al.	.....	D14/138
D566,676 S *	4/2008	Kim et al.	.....	D14/138
D567,789 S *	4/2008	Lee et al.	.....	D14/138
2006/0058079 A1 *	3/2006	Goto	.....	455/575.3

**OTHER PUBLICATIONS**

Samsung J630 telephone, announced Feb. 2008, [online], [site visited May 24, 2008]. Available from Internet ,<URL: http://www.gsmarena.com>.\*

Samsung C400 telephone, announced Sep. 2006, [online], [site visited May 24, 2008]. Available from Internet ,<URL: http://www.gsmarena.com>.\*

Samsung D830 telephone, announced Jun. 2006, [online], [site visited May 24, 2008]. Available from Internet ,<URL: http://www.gsmarena.com>.\*

Panasonic X400 telephone announced 2<sup>nd</sup> quarter 2004, [online], [site visited May 24, 2008]. Available from Internet ,<URL: http://www.gsmarena.com>.\*

NEC N900iG telephone, announced 4th quarter 2004, [online], [site visited May 24, 2008]. Available from Internet ,<URL: http://www.gsmarena.com>.\*

Samsung X510 telephone, announced Oct. 2006, [online], [site visited May 24, 2008]. Available from Internet ,<URL: http://www.gsmarena.com>.\*

\* cited by examiner

*Primary Examiner*—Jeffrey D Asch

(74) *Attorney, Agent, or Firm*—Ladas & Parry LLP

(57) **CLAIM**

We claim the ornamental design for mobile phone, as shown.

**DESCRIPTION**

FIG. 1 is a front/right-side/top perspective view of a mobile phone showing our new design;

FIG. 2 is a front elevational view thereof;

FIG. 3 is a rear elevational view thereof;

FIG. 4 is a left-side elevational view thereof;

FIG. 5 is a right-side elevational view thereof;

FIG. 6 is a top-side elevational view thereof; and,

FIG. 7 is a bottom-side elevational view thereof.

**1 Claim, 6 Drawing Sheets**

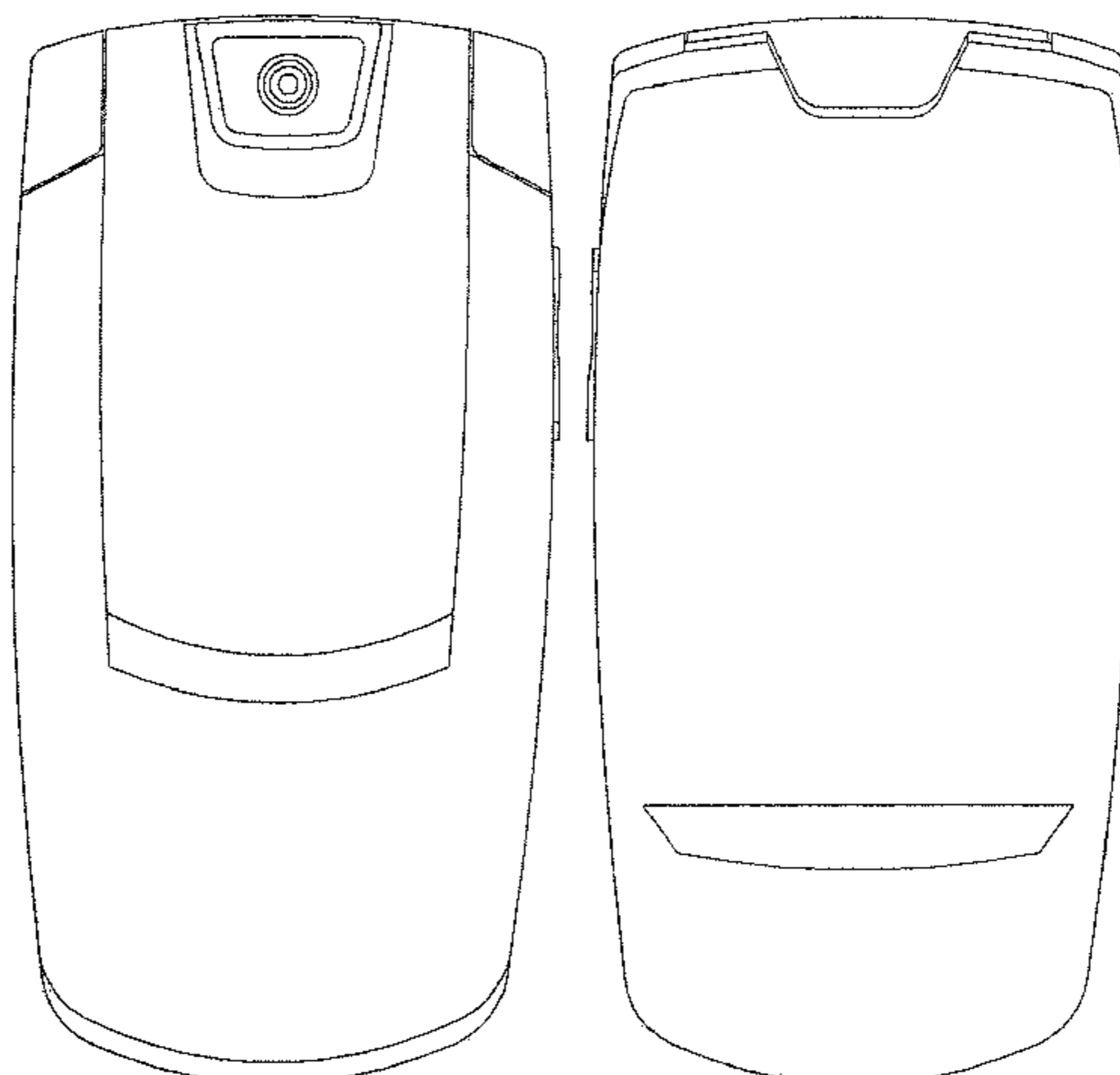

FIG. 1

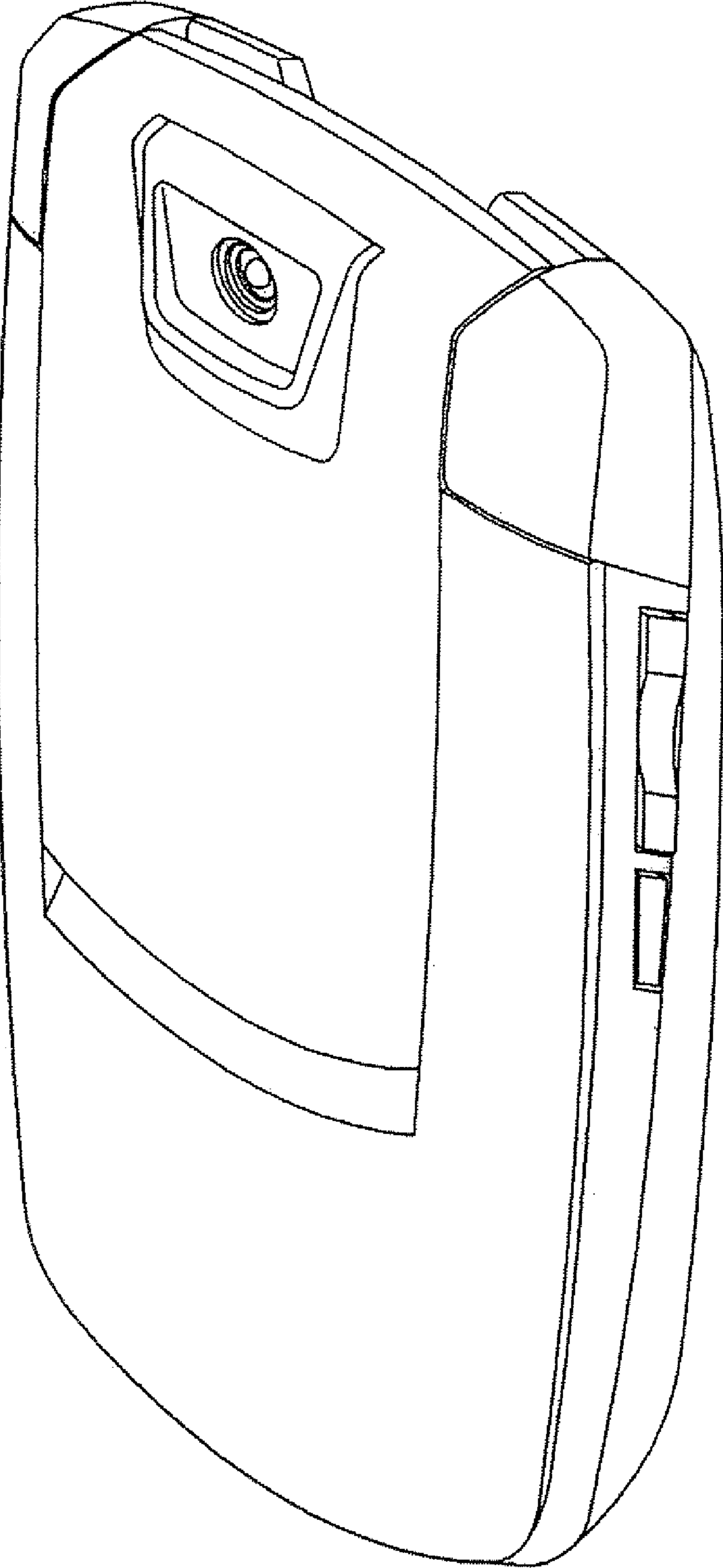

FIG. 2

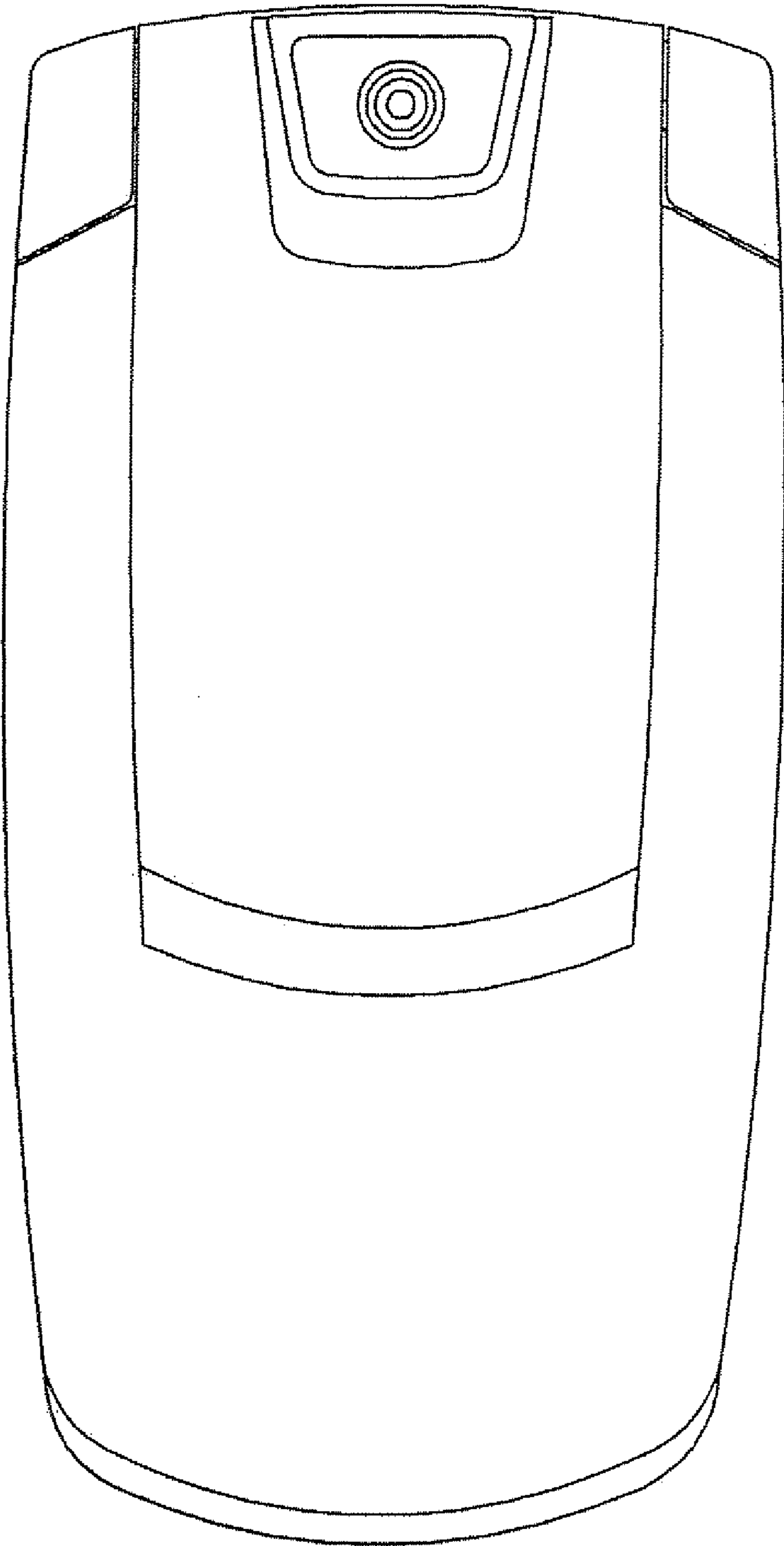

FIG. 3

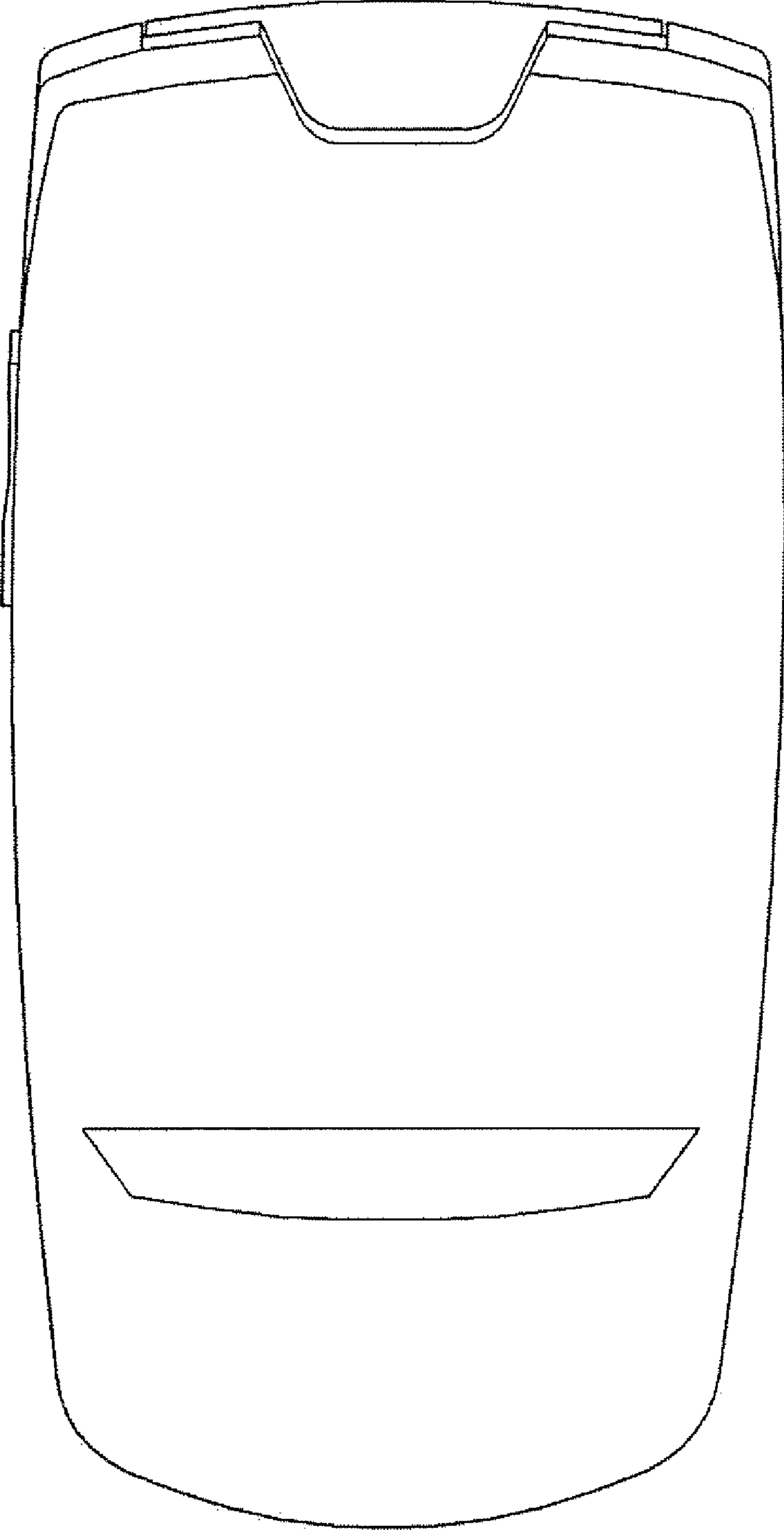

FIG. 4

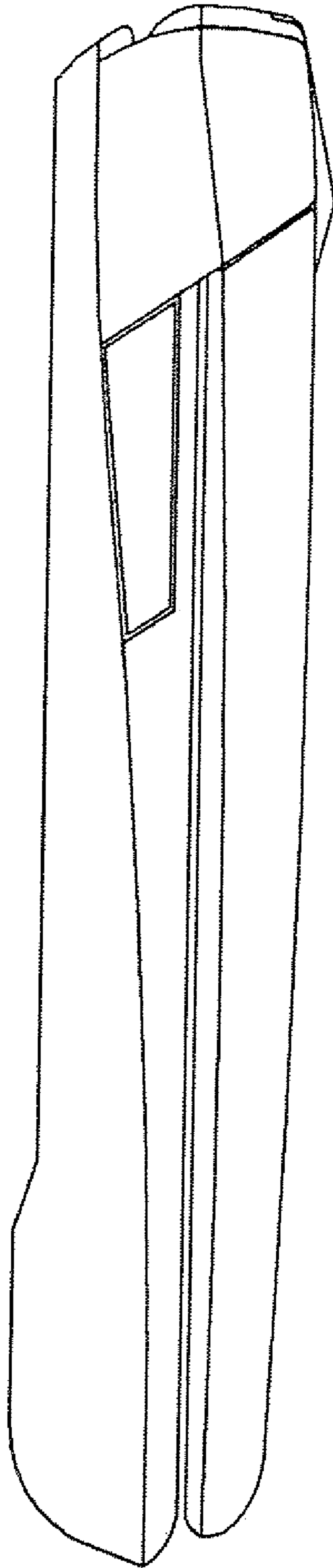

FIG. 5

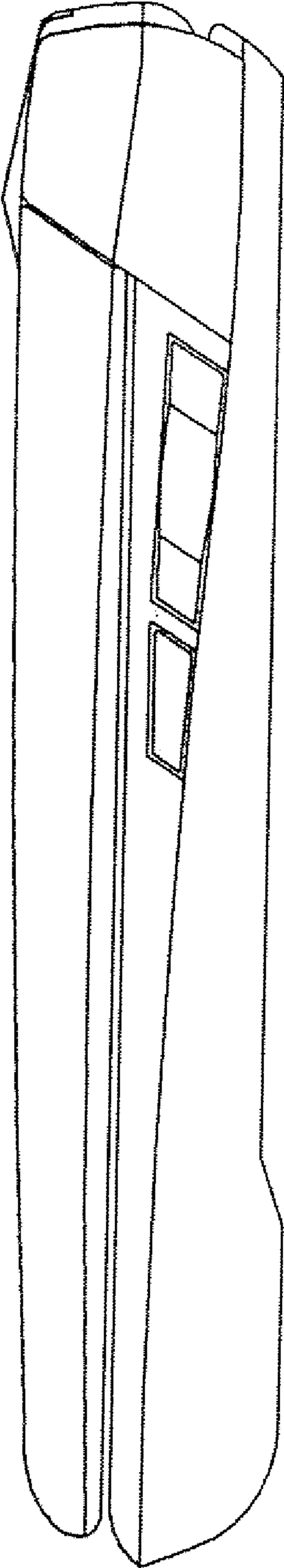

FIG. 6

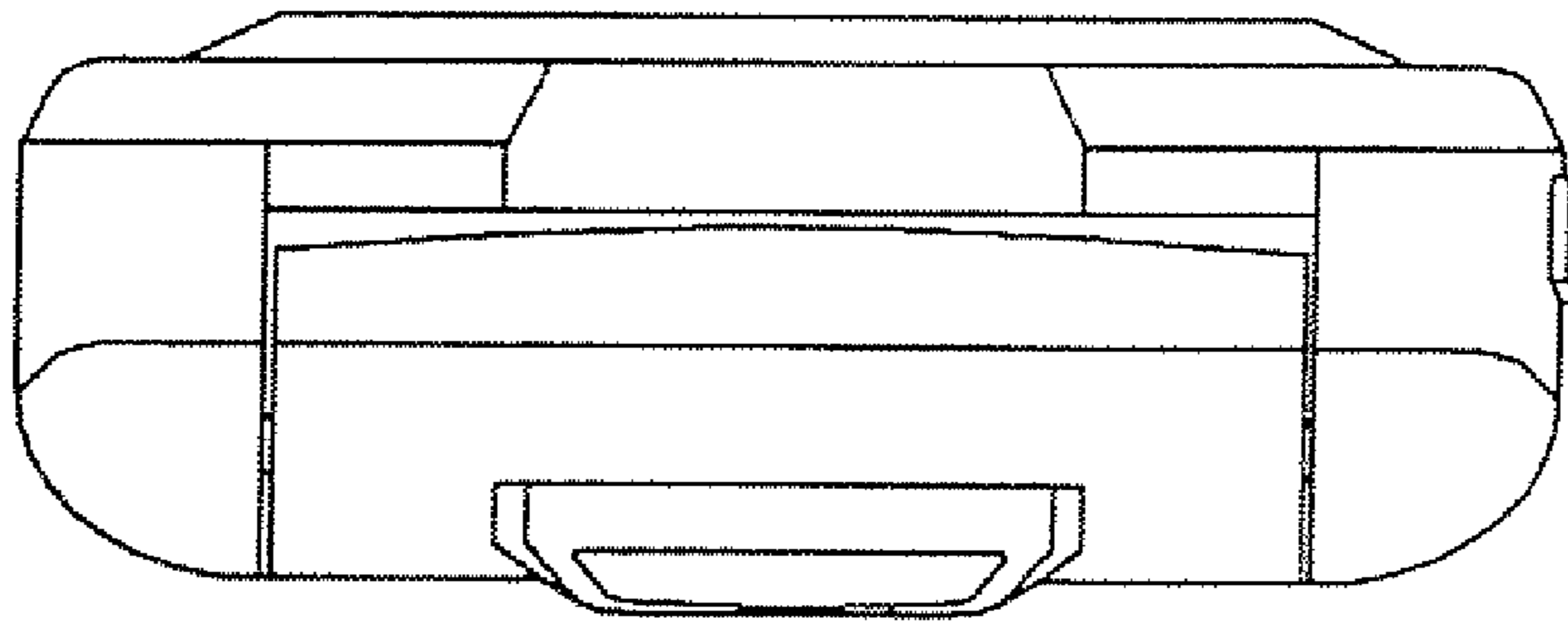

FIG. 7

