



US00D583776S

(12) **United States Design Patent**  
**Lacour et al.**

(10) **Patent No.:** **US D583,776 S**  
(45) **Date of Patent:** **\*\* Dec. 30, 2008**

(54) **REMOTE CONTROL**

(75) Inventors: **Olivier Lacour**, Paris (FR); **Ferline Tiard**, Paris (FR); **Thorsten Buch**, Munich (DE); **Harold Cornier**, Paris (FR); **Gilles Poplin**, Malakoff (FR)

(73) Assignee: **NDS Technologies France**, Issy-les-Moulineaux (FR)

(\*\*) Term: **14 Years**

(21) Appl. No.: **29/294,899**

(22) Filed: **Jan. 31, 2008**

(30) **Foreign Application Priority Data**

Sep. 5, 2007 (EM) ..... 000787122-0001

(51) **LOC (8) Cl.** ..... **13-03**

(52) **U.S. Cl.** ..... **D13/168**

(58) **Field of Classification Search** ..... D13/168;  
D10/104, 106; D14/218, 247; 340/825.22,  
340/825.24, 825.25, 825.31, 825.36, 825.69,  
340/825.72; 341/20, 22, 23, 34, 176; 345/156,  
345/158, 169; 348/734; 455/92, 95, 100,  
455/128, 151.1–151.4, 352–355; 463/39;  
700/17, 19, 20, 65, 83

See application file for complete search history.

(56) **References Cited**

**U.S. PATENT DOCUMENTS**

D313,973 S \* 1/1991 Walker ..... D13/168  
D343,387 S \* 1/1994 Keene ..... D13/168  
D348,435 S \* 7/1994 Farinelli et al. .... D13/168  
D382,271 S \* 8/1997 Akwiwu ..... D14/218  
D406,542 S \* 3/1999 Mik ..... D10/104

D423,509 S \* 4/2000 Park ..... D14/218  
D546,295 S \* 7/2007 Marchetto et al. .... D13/168  
D547,275 S \* 7/2007 Bonnaud ..... D13/168

**FOREIGN PATENT DOCUMENTS**

EM 000294434-0002 5/2005  
EM 000321971-0001 6/2005  
EM 000501838-0001 5/2006  
EM 000539275-0001 7/2006  
EM 000547740-0002 8/2006  
EM 000567110-0006 8/2006  
EM 000632260-0001 12/2006  
EM 000653571-0001 2/2007  
EM 000653571-0002 2/2007

\* cited by examiner

*Primary Examiner*—Selina Sikder

(74) *Attorney, Agent, or Firm*—Husch Blackwell Sanders LLP

(57) **CLAIM**

The ornamental design for a remote control, as shown and described.

**DESCRIPTION**

FIG. 1 is a perspective view of the front, right side and bottom of the remote control design;

FIG. 2 is a perspective view of the rear, left side and bottom thereof;

FIG. 3 is a front elevational view thereof;

FIG. 4 is a rear elevational view thereof;

FIG. 5 is a left side elevational view thereof;

FIG. 6 is a right side elevational view thereof; and,

FIG. 7 is a top view thereof.

**1 Claim, 3 Drawing Sheets**

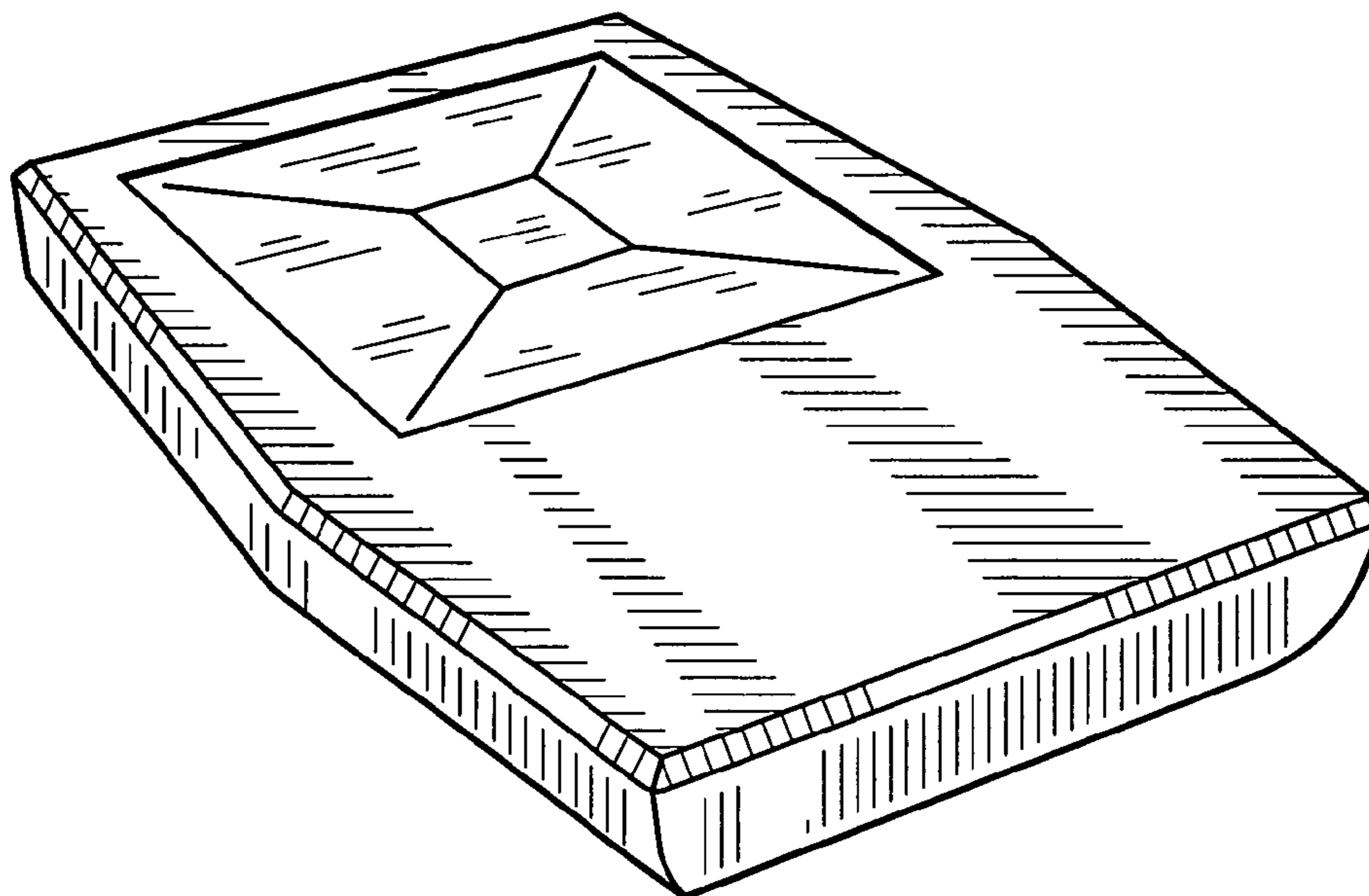
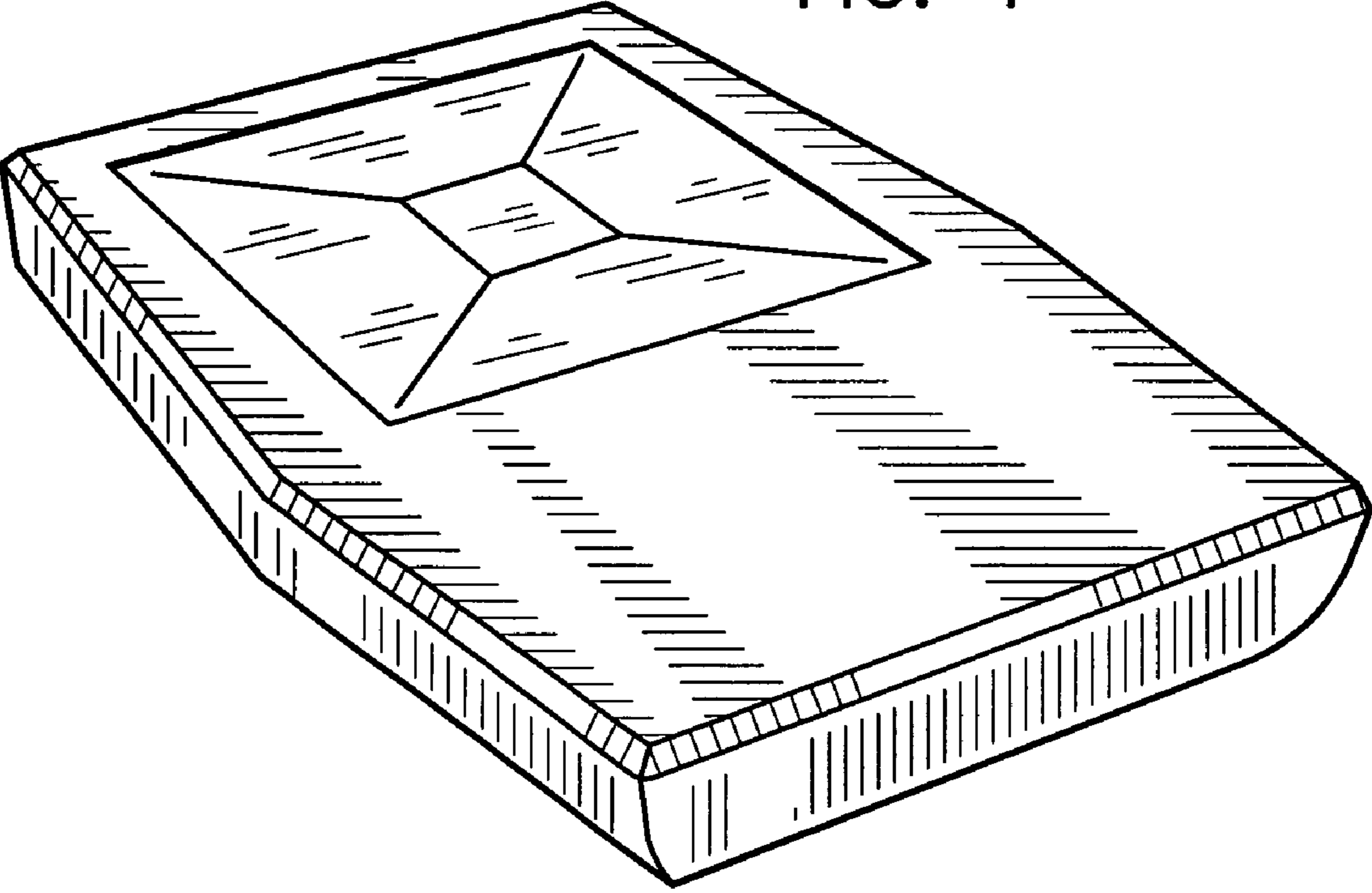

FIG. 1



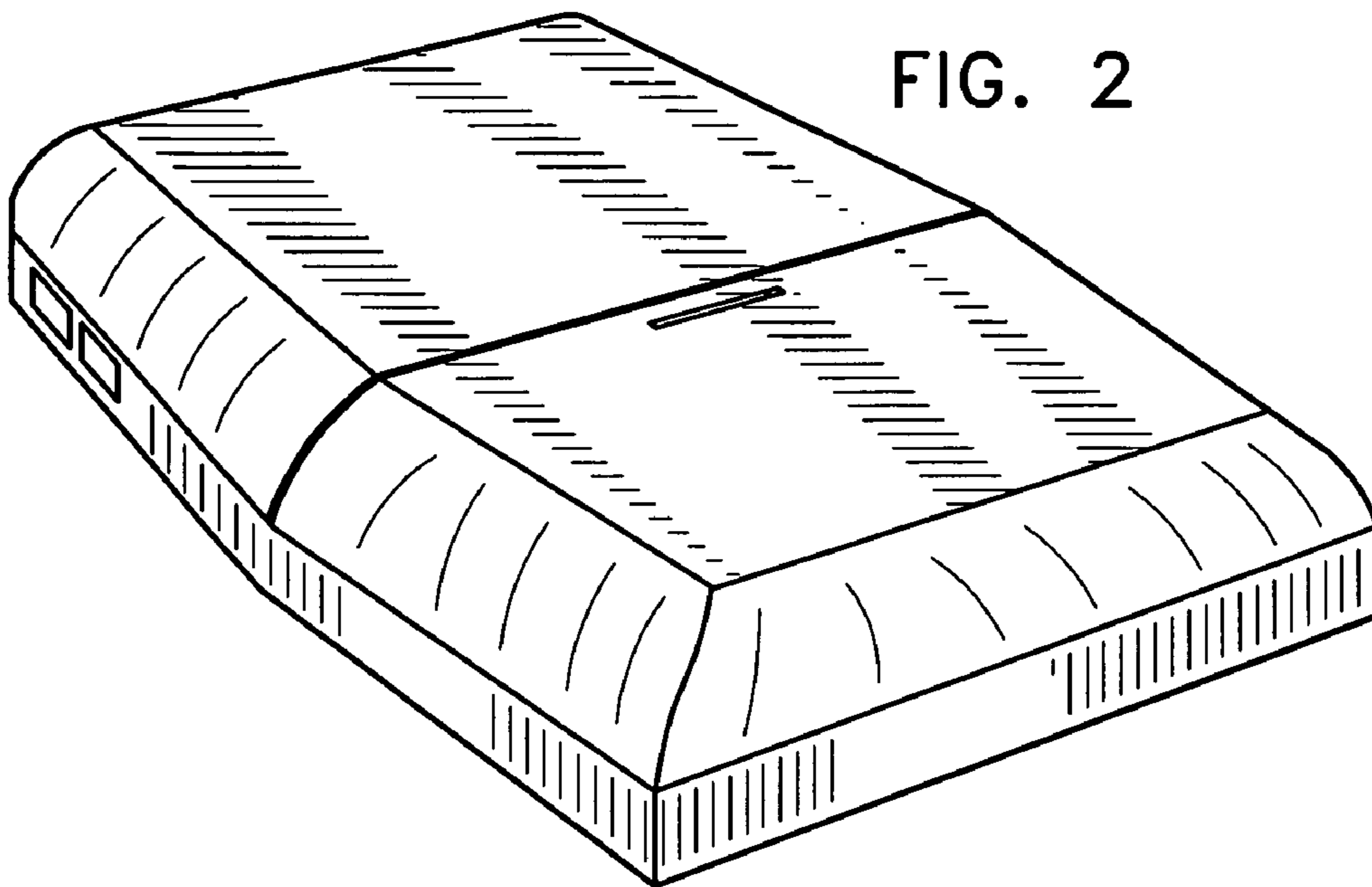

FIG. 3

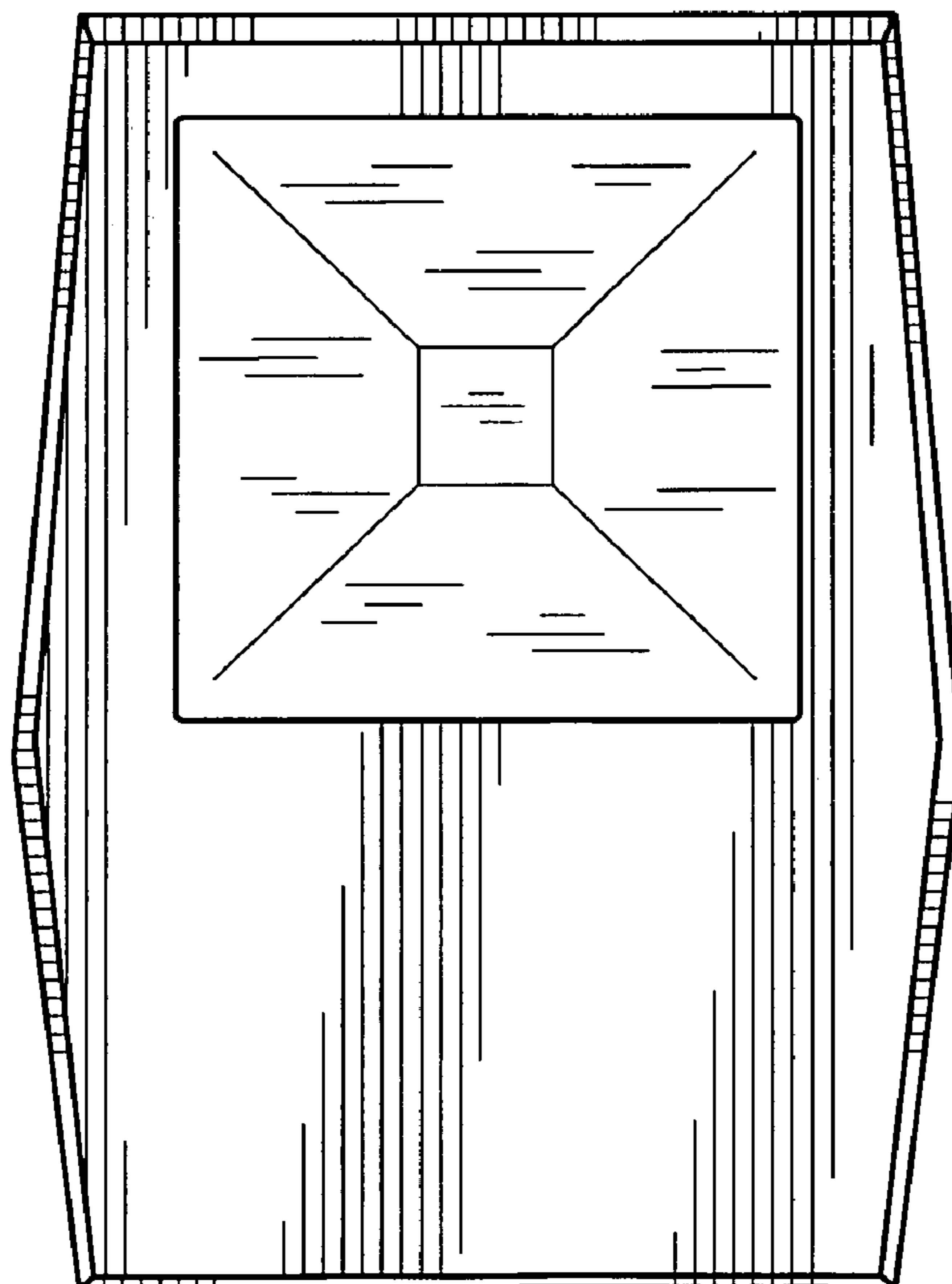

FIG. 4

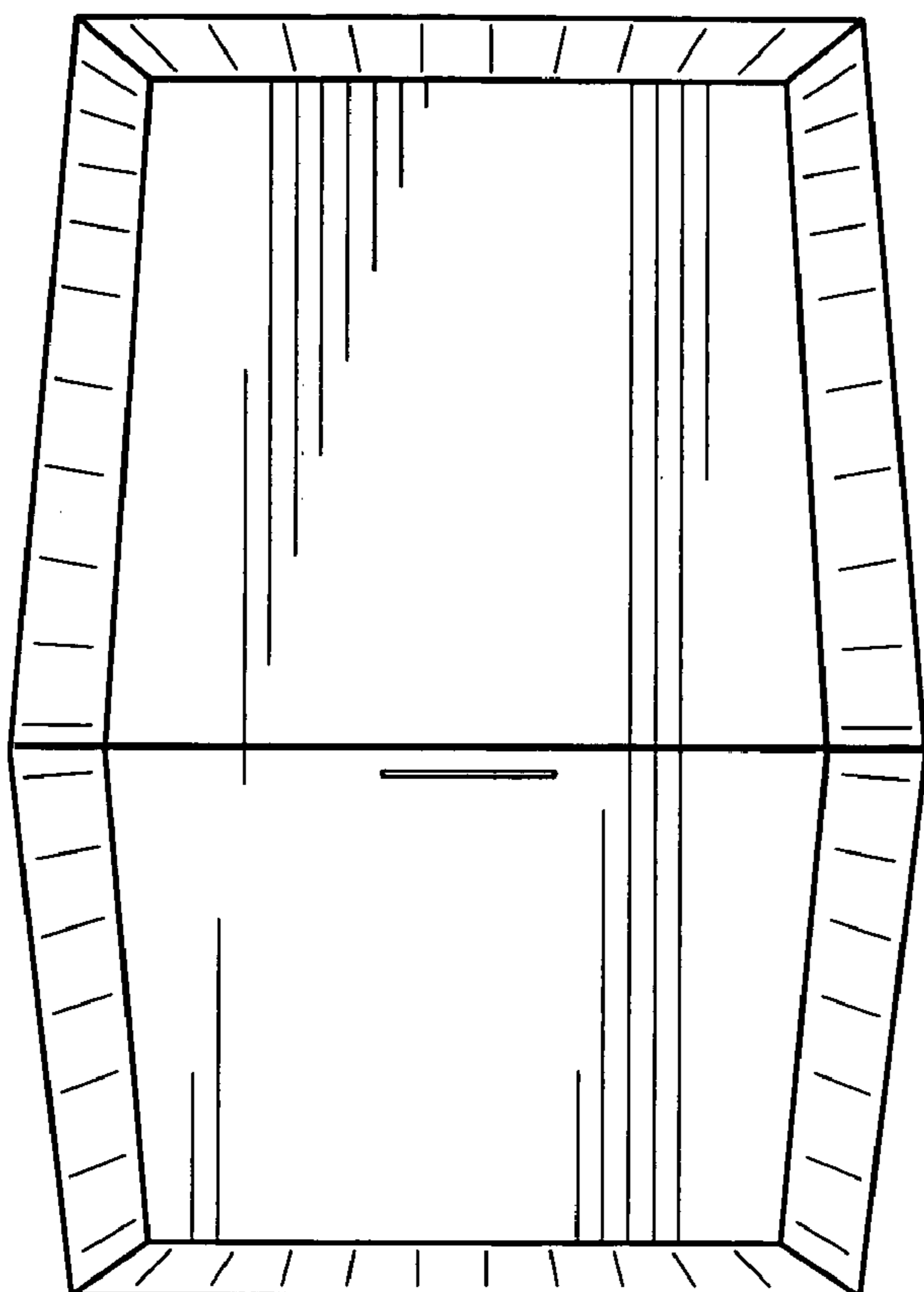

FIG. 5

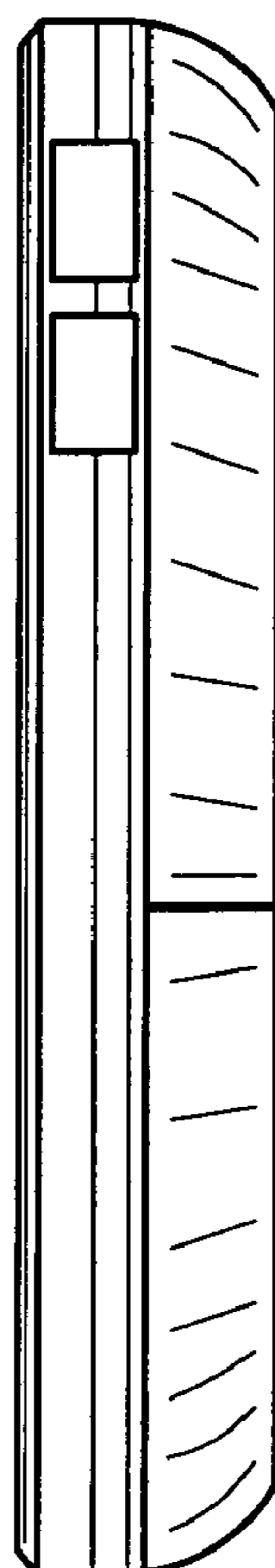

FIG. 6

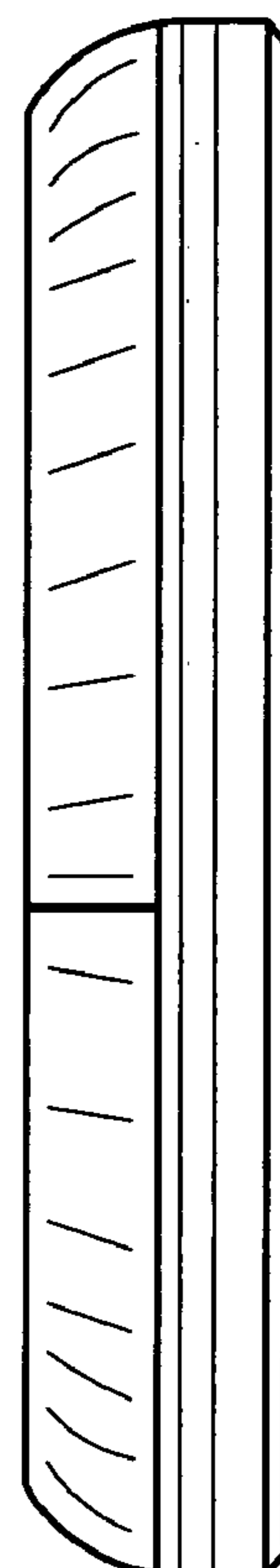

FIG. 7

