



US00D583633S

(12) **United States Design Patent**
Vendl

(10) **Patent No.:** **US D583,633 S**

(45) **Date of Patent:** **** Dec. 30, 2008**

(54) **PUMPKIN STACKABLE COOKIE CUTTER SET**

6,267,036 B1 * 7/2001 Lani 30/315

* cited by examiner

(75) Inventor: **Lynn Vendl**, Woodridge, IL (US)

Primary Examiner—Terry A Wallace

(73) Assignee: **Wilton Industries, Inc.**, Woodridge, IL (US)

(74) *Attorney, Agent, or Firm*—DLA Piper LLP; Jennifer E. Lacroix

(**) Term: **14 Years**

(57) **CLAIM**

(21) Appl. No.: **29/320,399**

The ornamental design for a pumpkin stackable cookie cutter set, as shown and described.

(22) Filed: **Jun. 26, 2008**

DESCRIPTION

(51) **LOC (8) Cl.** **07-04**

FIG. 1 is a perspective view of the pumpkin stackable cookie cutter set;

(52) **U.S. Cl.** **D7/675**

FIG. 2 is a left side elevational view of the pumpkin stackable cookie cutter set;

(58) **Field of Classification Search** D7/675,
D7/676, 354, 357; D1/106, 107; 30/314–316,
30/299, 301

FIG. 3 is a right side elevational view of the pumpkin stackable cookie cutter set;

See application file for complete search history.

FIG. 4 is a top plan view of the pumpkin stackable cookie cutter set;

(56) **References Cited**

U.S. PATENT DOCUMENTS

2,612,123	A *	9/1952	Nord	30/316
2,754,587	A *	7/1956	Bylkas	30/301
4,327,489	A *	5/1982	Conrad	30/299
D282,893	S *	3/1986	Daenen	D7/676
5,921,153	A *	7/1999	Barnett	30/315
5,933,968	A *	8/1999	Solomon	30/315

FIG. 5 is a bottom plan view of the pumpkin stackable cookie cutter set; and,

FIG. 6 is an exploded view of the pumpkin stackable cookie cutter set.

1 Claim, 3 Drawing Sheets

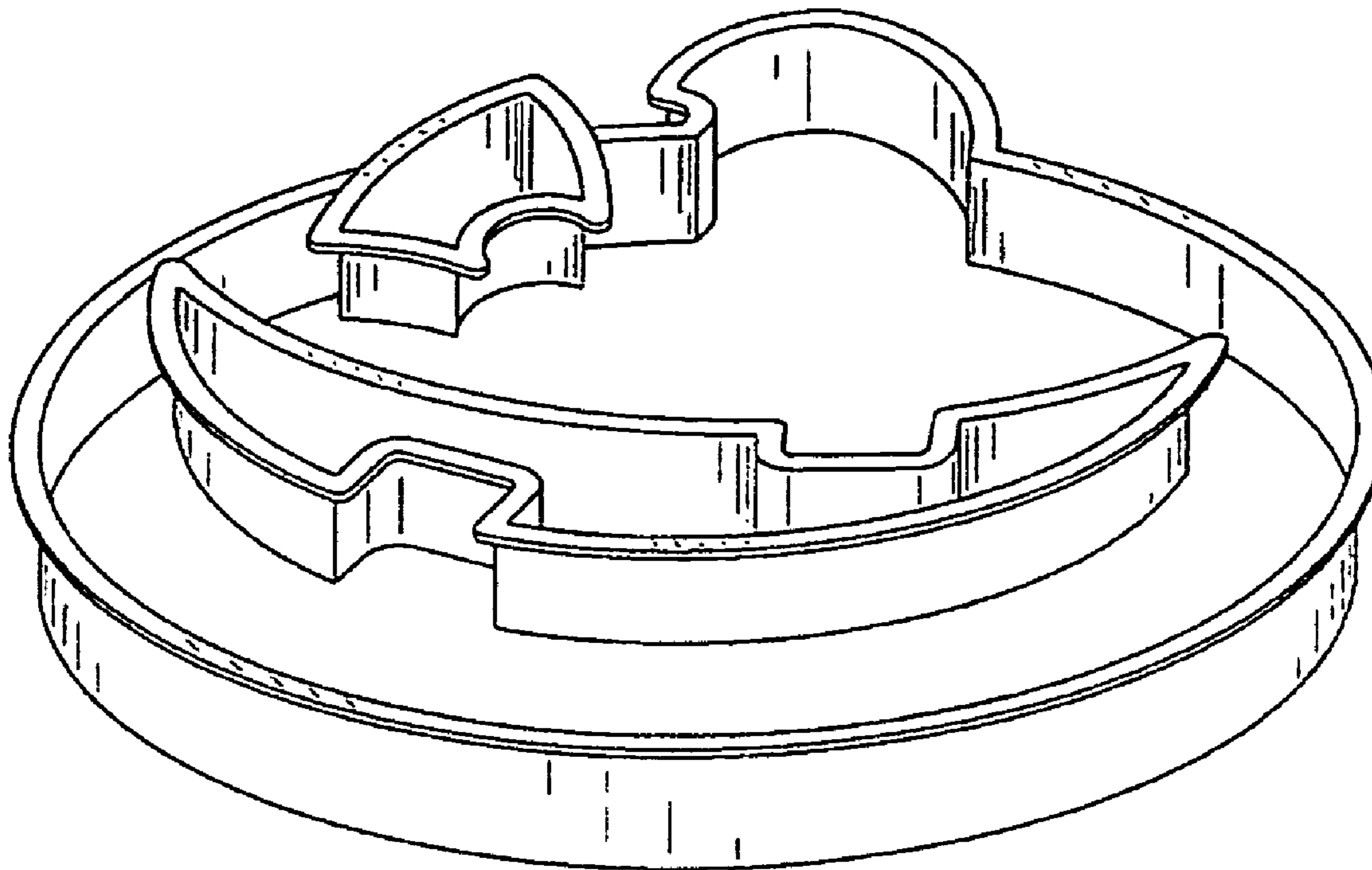

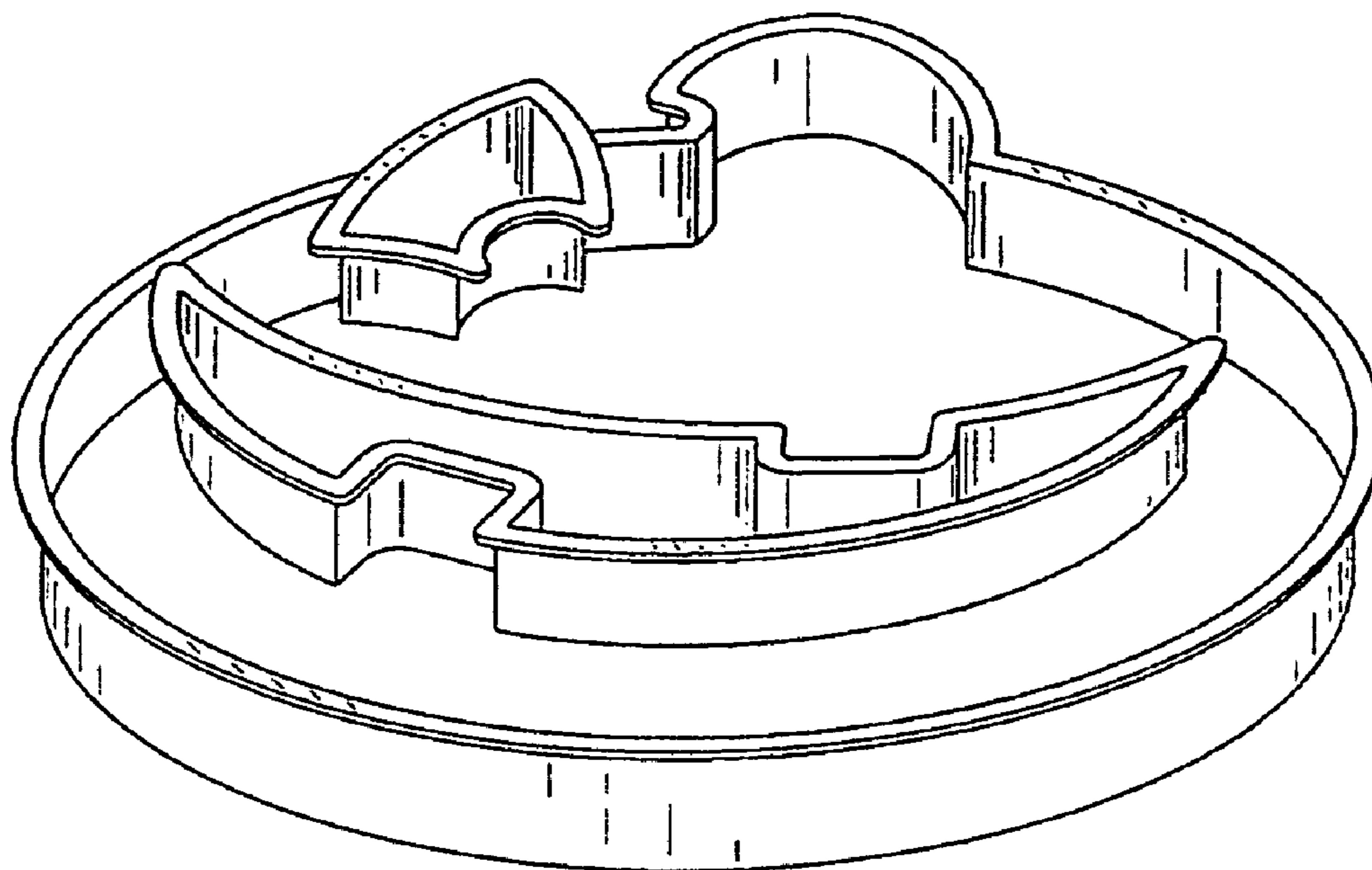

FIG. 1

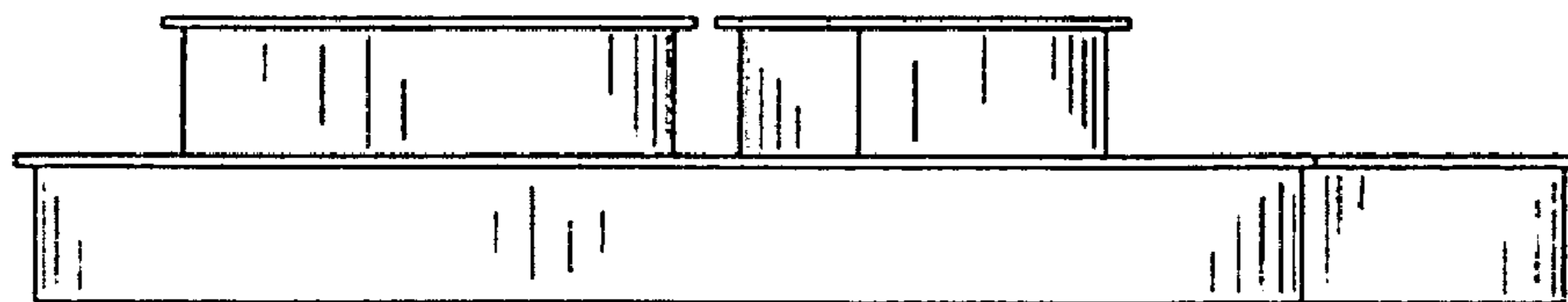

FIG. 2

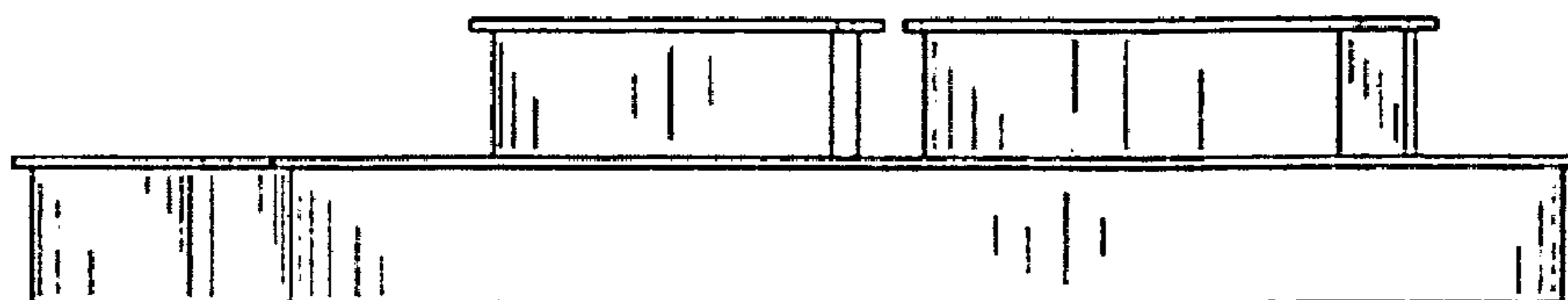

FIG. 3

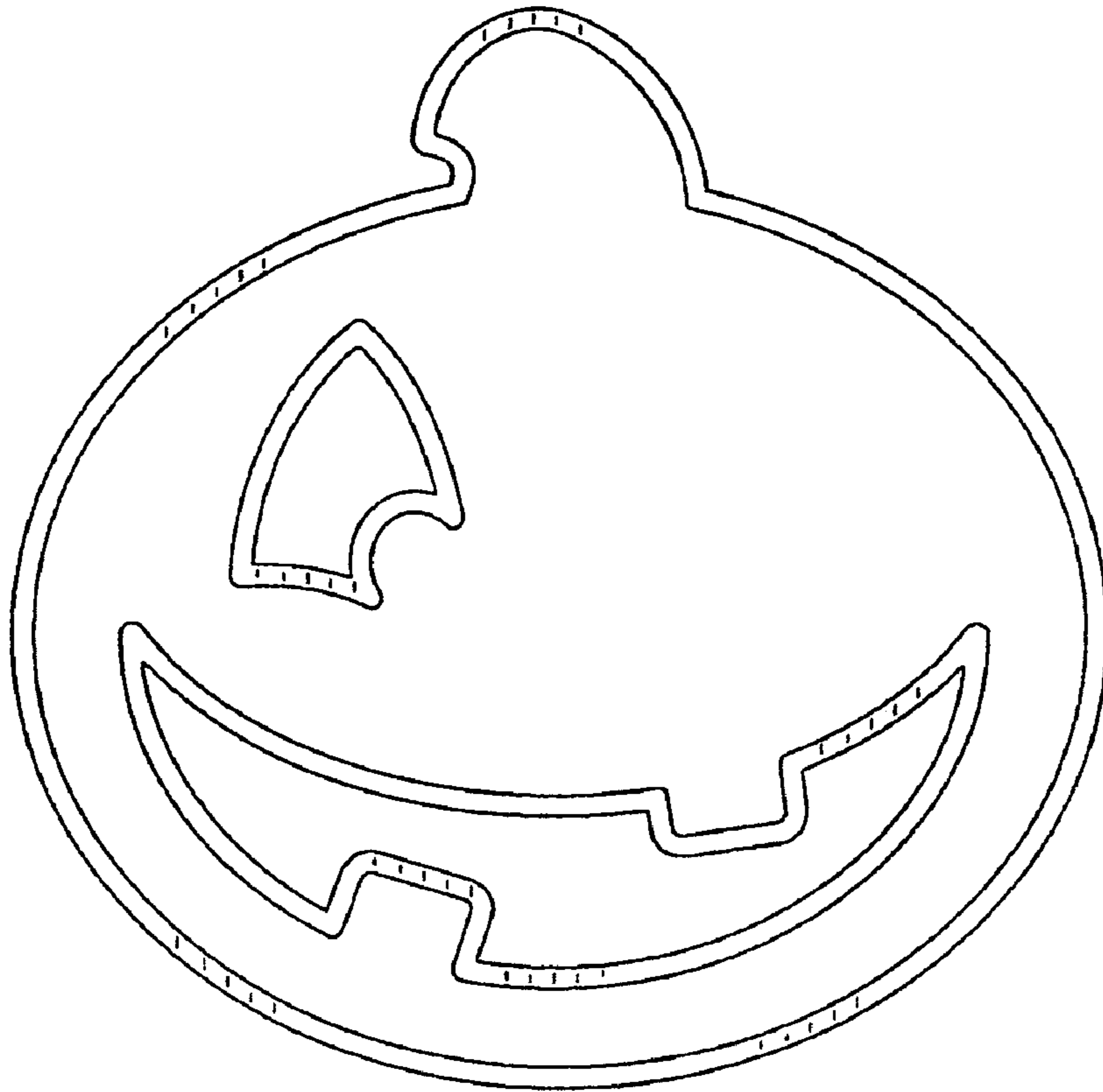

FIG. 4

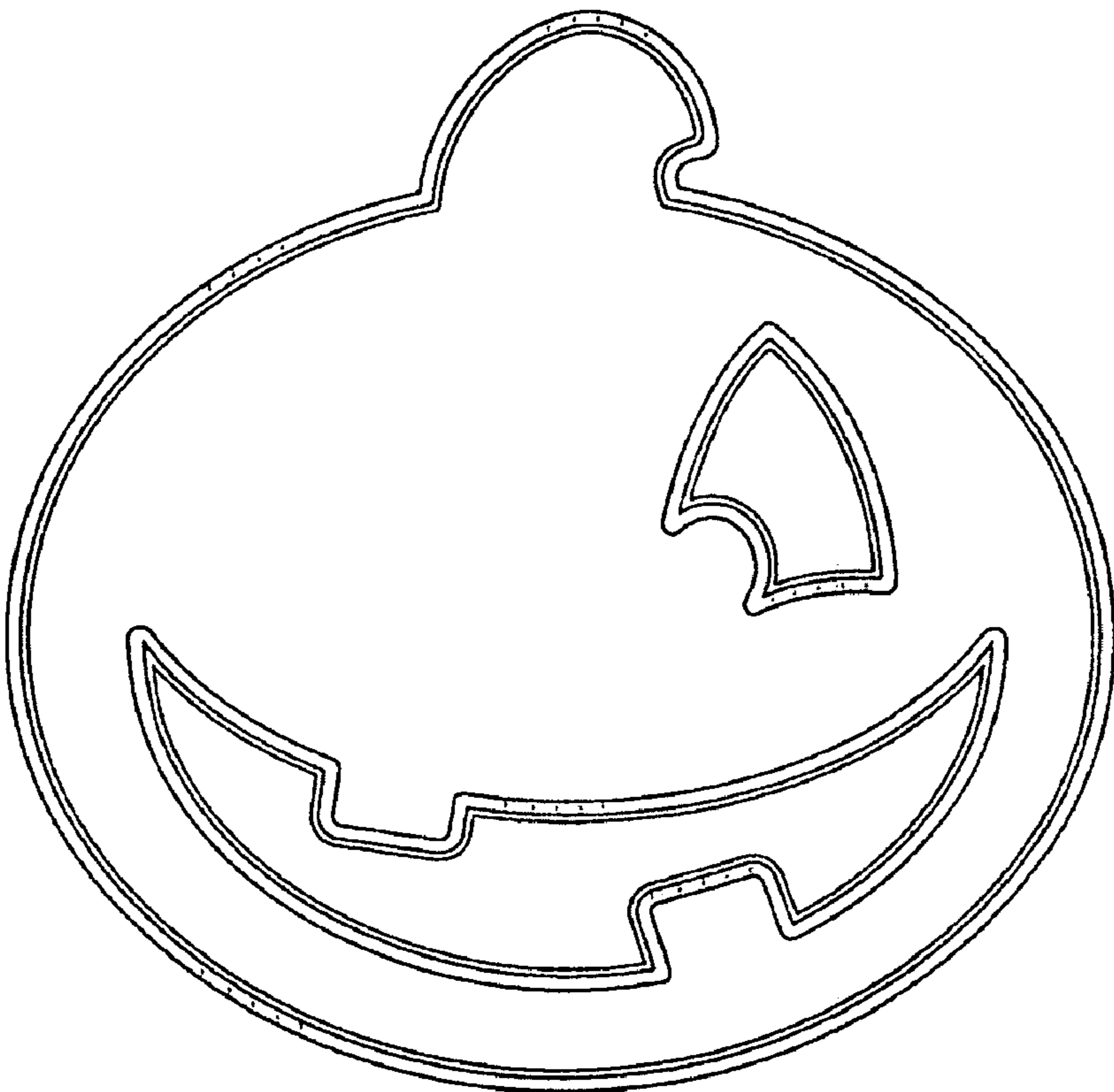

FIG. 5

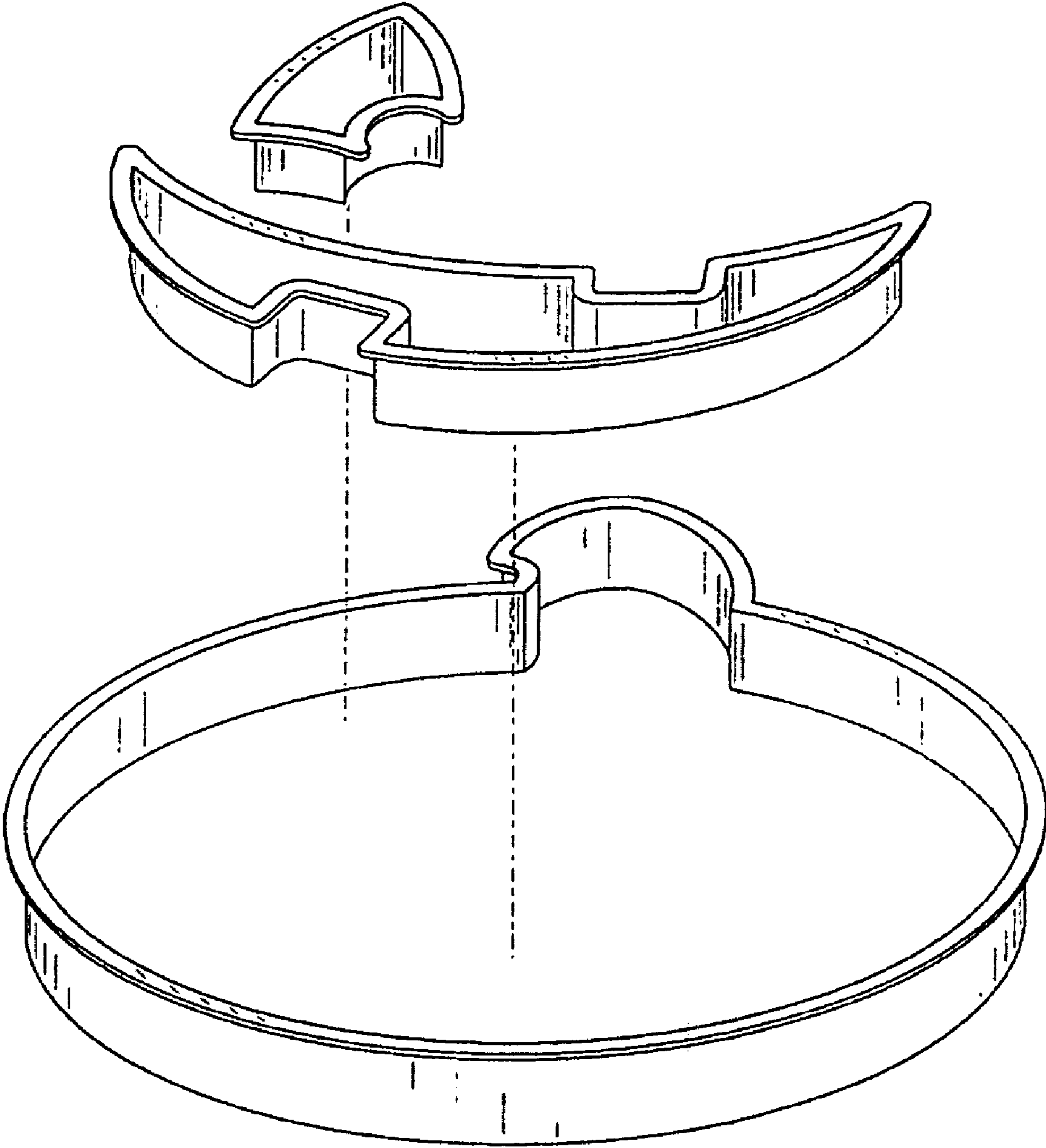

FIG. 6