



US00D583628S

(12) **United States Design Patent**
Meiry et al.

(10) **Patent No.:** **US D583,628 S**

(45) **Date of Patent:** **** Dec. 30, 2008**

(54) **COMBINED SALT AND PEPPER MILL
ADAPTED TO RESEMBLE SLOT MACHINES**

5,984,782 A * 11/1999 Inoue D21/370

(76) Inventors: **Ron Meiry**, 559 Lacabana Beach, Las Vegas, NV (US) 89138; **Ronen Tregerman**, 9811 W. Charleston Blvd., #2-523, Las Vegas, NV (US) 89117

* cited by examiner

Primary Examiner—Terry A Wallace
(74) *Attorney, Agent, or Firm*—Eric Karich

(**) Term: **14 Years**

(57) **CLAIM**

(21) Appl. No.: **29/299,748**

The ornamental design for a combined salt and pepper mill adapted to resemble slot machines, as shown.

(22) Filed: **Jan. 3, 2008**

DESCRIPTION

(51) **LOC (8) Cl.** **07-08**

(52) **U.S. Cl.** **D7/599**; D7/679

(58) **Field of Classification Search** D7/590–598,
D7/401.1, 679; D9/523–525; D21/370;
241/168, 169, 285.3, 93; 222/142.1–142.9,
222/480–482, 452

FIG. 1 is a perspective view of combined salt and pepper mill adapted to resemble slot machines, showing my new design; FIG. 2 is a front elevational view thereof; FIG. 3 is a rear elevational view thereof; FIG. 4 is a left side elevational view thereof; FIG. 5 is a right side elevational view thereof; FIG. 6 is a top plan view thereof; and, FIG. 7 is a bottom plan view thereof.

See application file for complete search history.

(56) **References Cited**

U.S. PATENT DOCUMENTS

D206,498 S * 12/1966 Pastorius D9/523
5,823,874 A * 10/1998 Adams D21/370

1 Claim, 4 Drawing Sheets

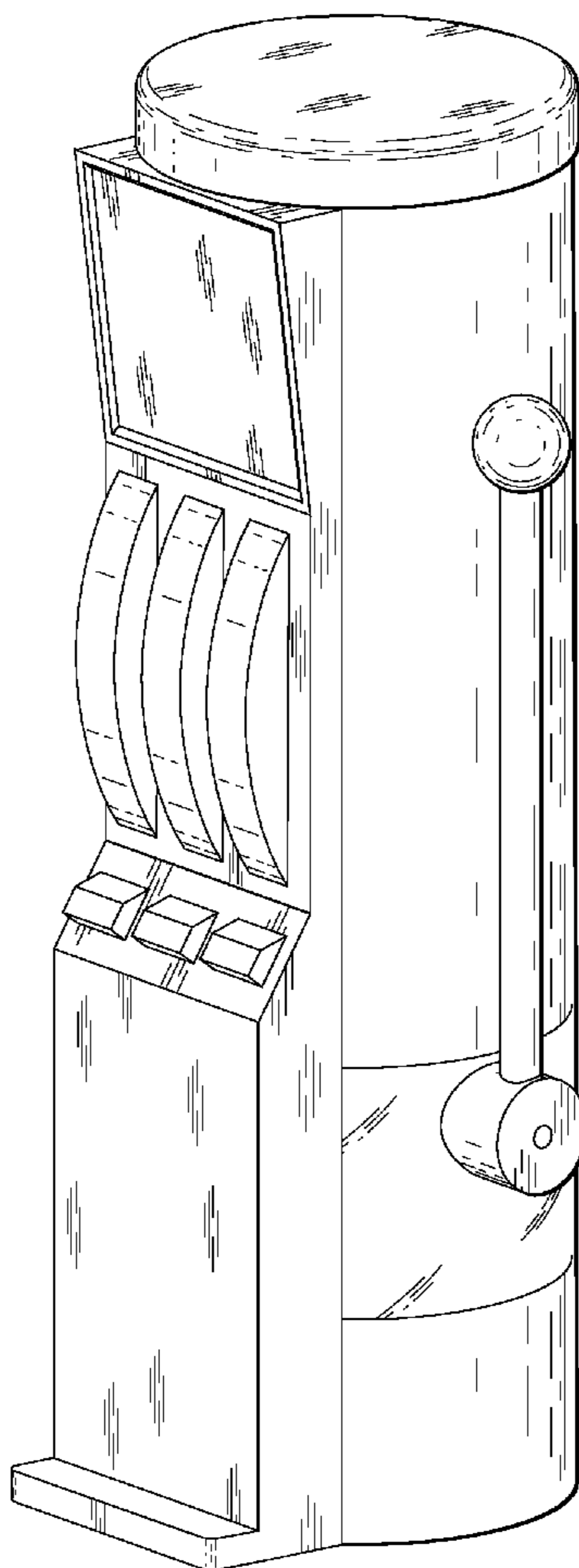

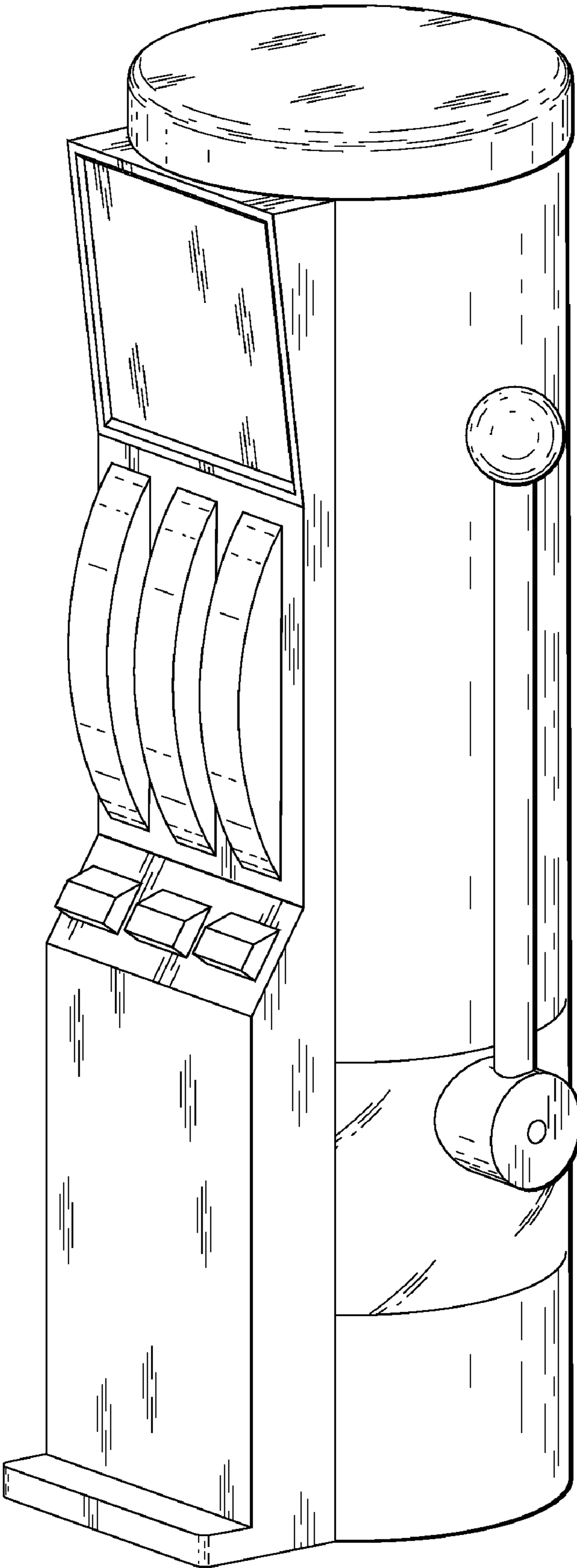

Fig. 1

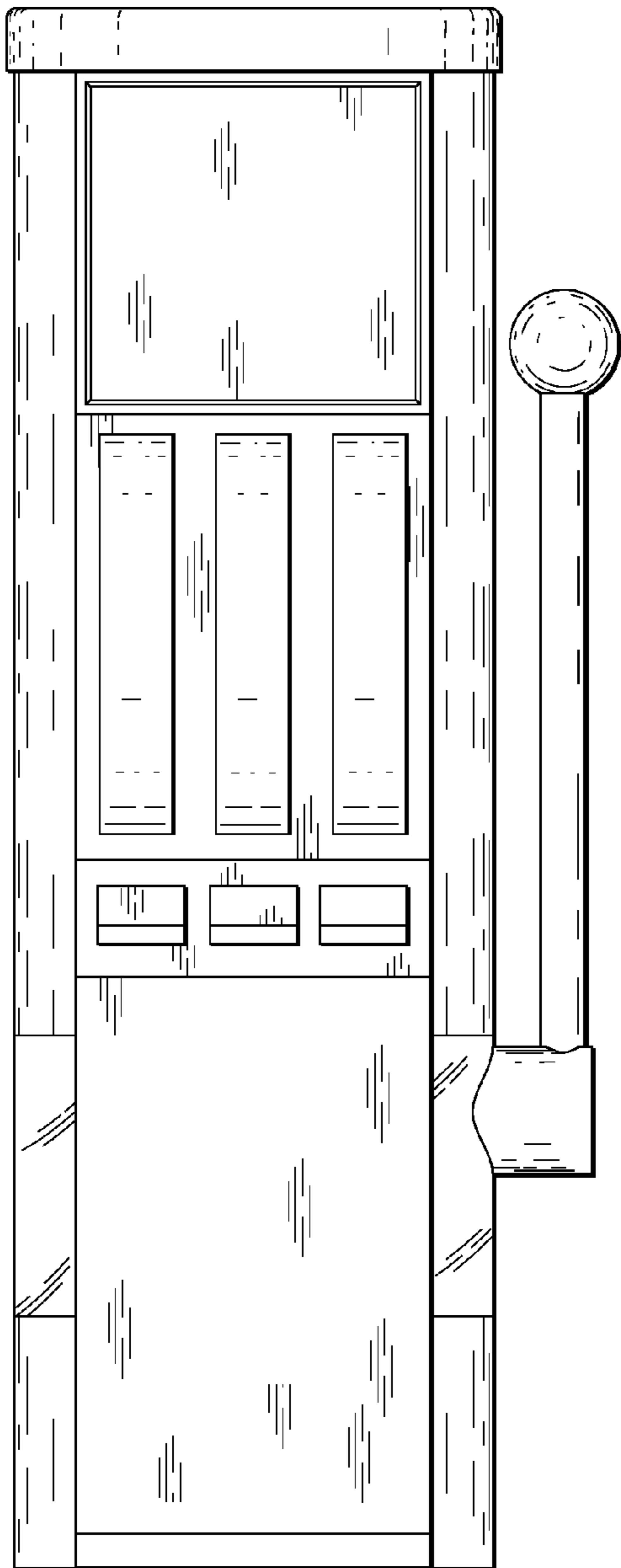

Fig. 2

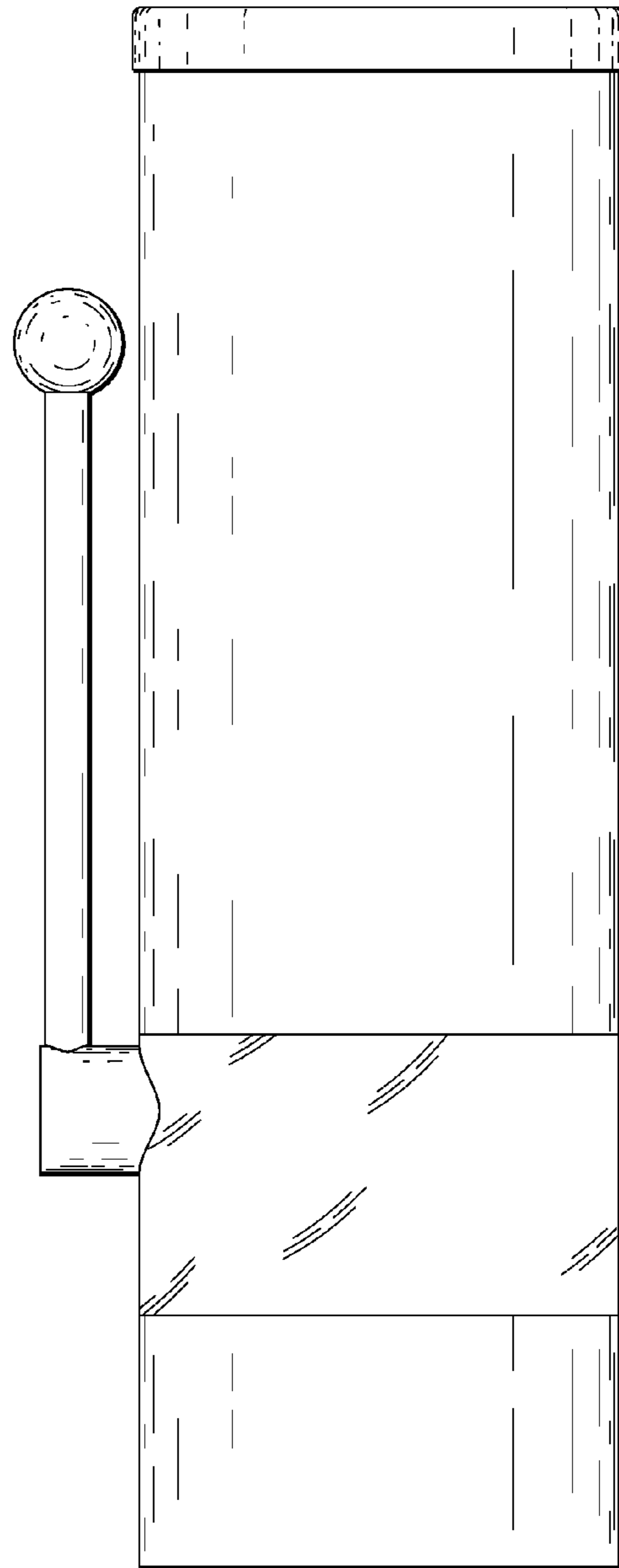

Fig. 3

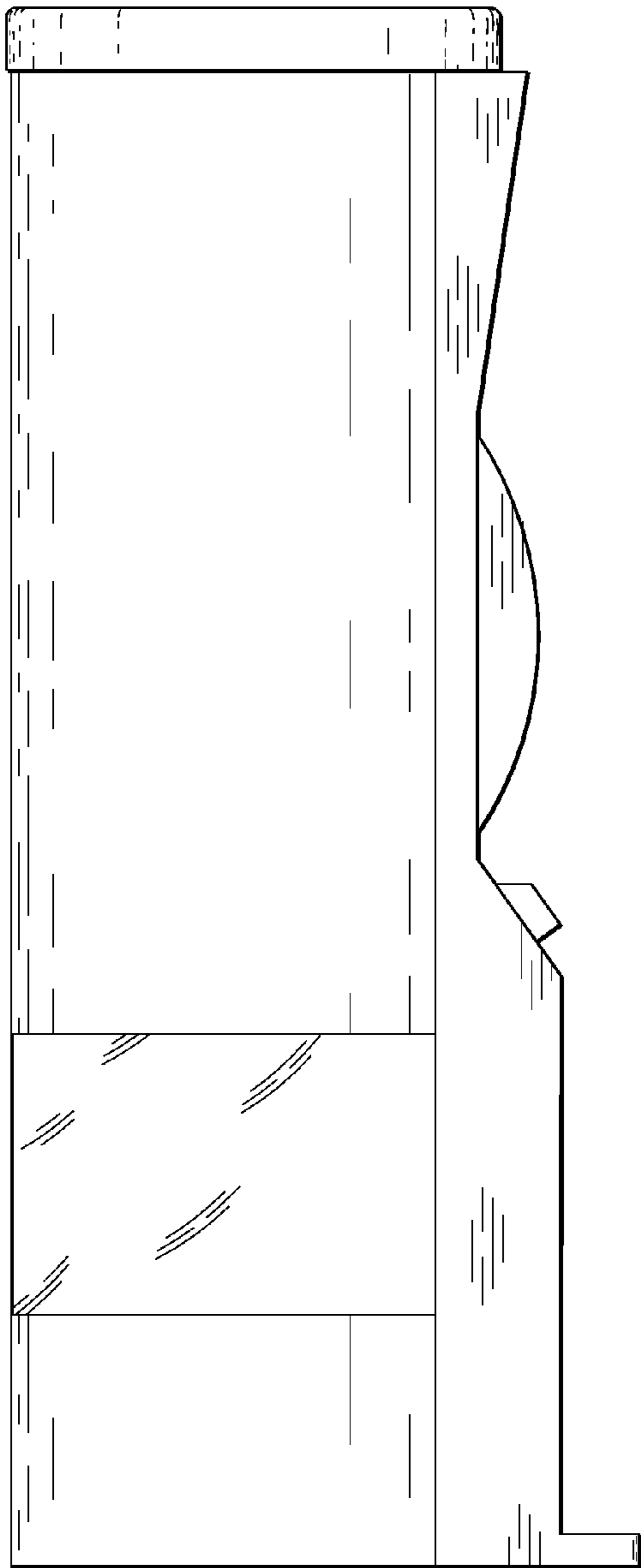

Fig. 4

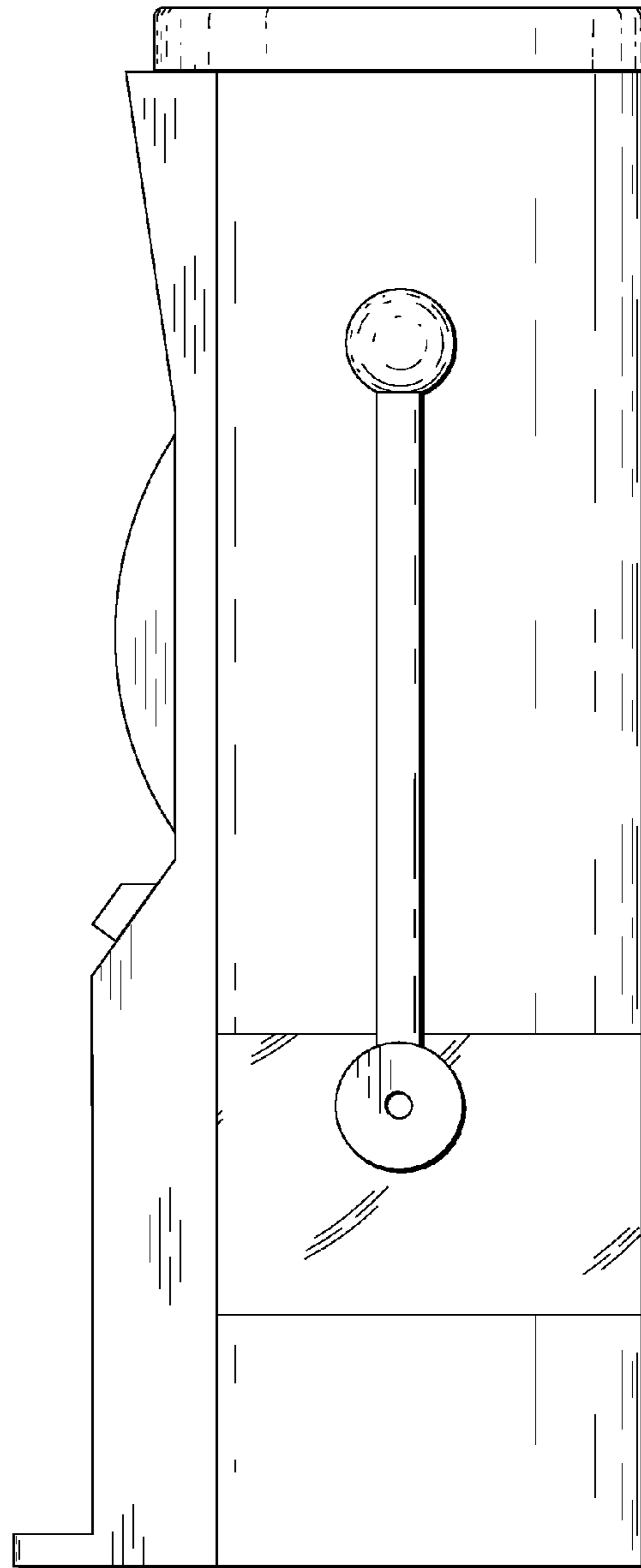

Fig. 5

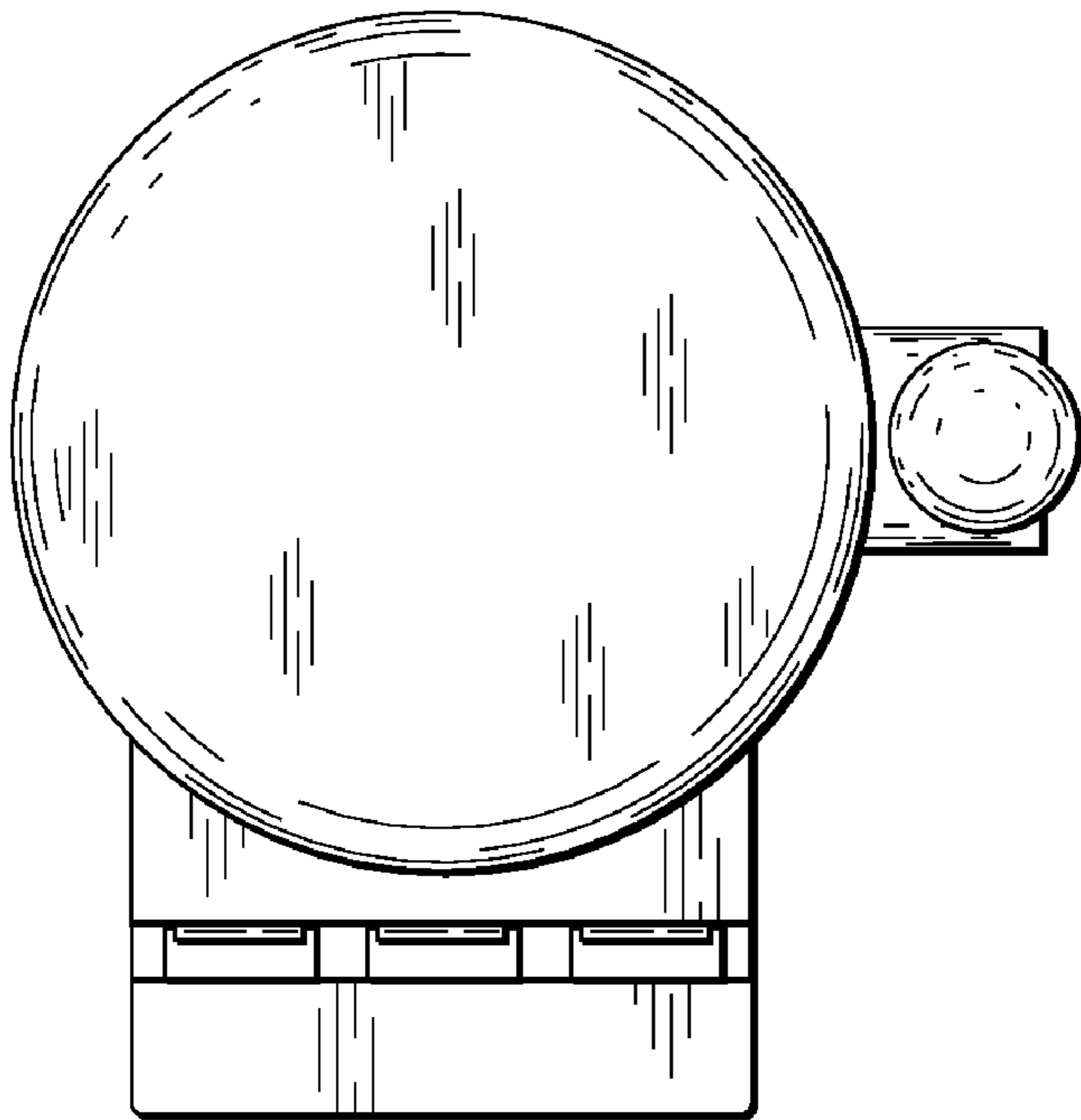

Fig. 6

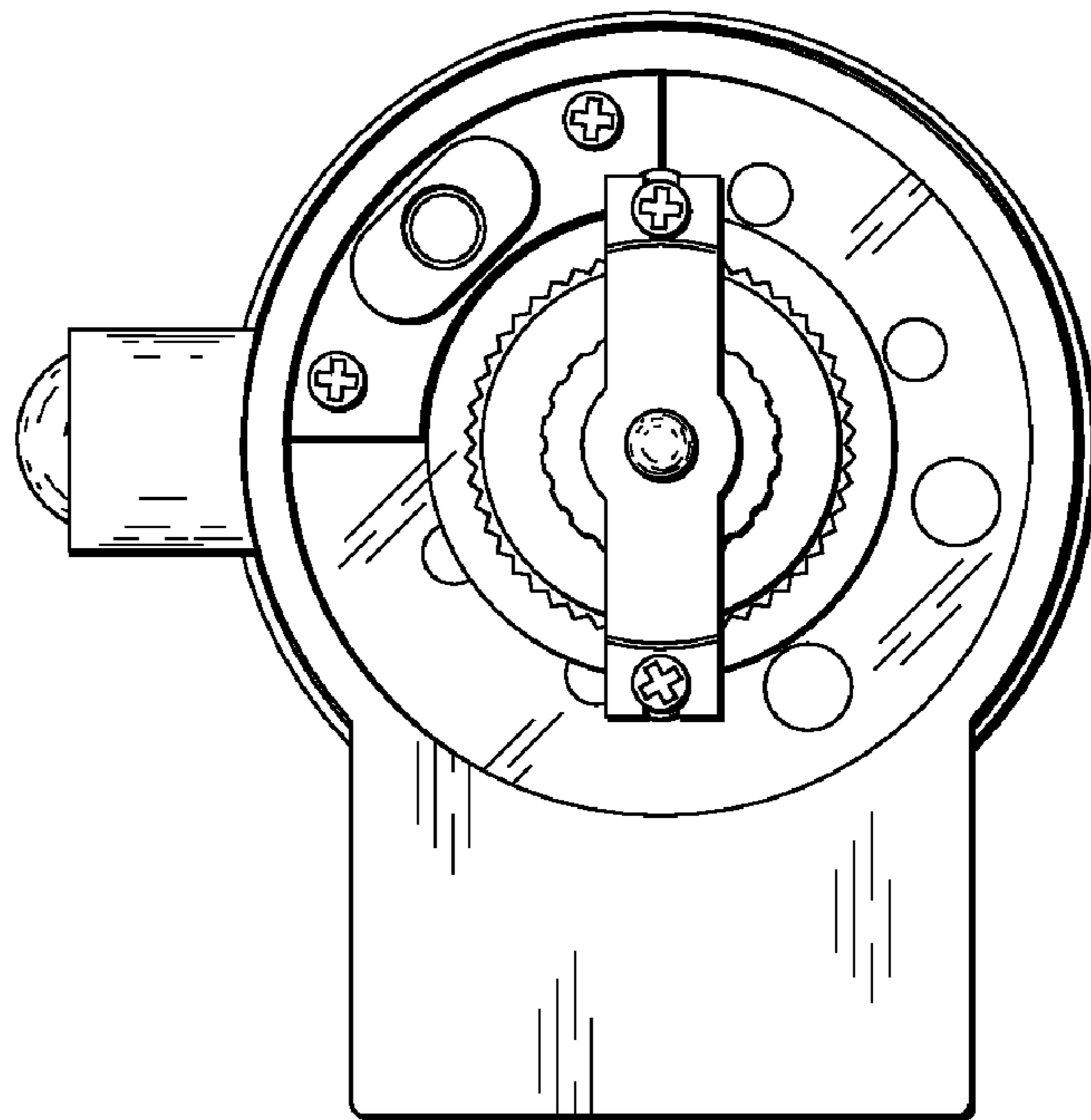

Fig. 7