



US00D583625S

(12) **United States Design Patent**  
**Martinez et al.**

(10) **Patent No.:** **US D583,625 S**  
(45) **Date of Patent:** **\*\* Dec. 30, 2008**

(54) **CUP AND TRAY ASSEMBLY**

(75) Inventors: **Gilbert Martinez**, Firestone, CO (US);  
**Darrell A. Kulzer**, Denver, CO (US)

(73) Assignee: **B & R Plastics, Inc.**, Denver, CO (US)

(\*\*) Term: **14 Years**

(21) Appl. No.: **29/280,737**

(22) Filed: **Jun. 6, 2007**

(51) **LOC (8) Cl.** ..... **07-01**

(52) **U.S. Cl.** ..... **D7/507; D7/505; D7/551.2;**  
**D7/567**

(58) **Field of Classification Search** ..... **D7/567,**  
**D7/544, 551.1, 549, 555, 507, 509, 505, 614;**  
**D30/130; 362/101; 211/77; 220/703, 575;**  
**229/125.17; 206/217, 542, 563**  
See application file for complete search history.

(56) **References Cited**

**U.S. PATENT DOCUMENTS**

D92,312 S *	5/1934	Kanter	.....	D7/507
D93,916 S *	11/1934	Erickson	.....	D7/507
D96,450 S *	8/1935	Daum	.....	D7/505
D116,522 S *	9/1939	Scanlon	.....	D7/507
D131,405 S *	2/1942	Dreitzer	.....	D7/556
2,276,678 A *	3/1942	Wheeler	.....	229/125.17
D183,379 S *	8/1958	Allay	.....	D28/77
3,060,494 A *	10/1962	Noble	.....	249/55
3,428,214 A *	2/1969	De Leon	.....	220/703
D222,498 S *	10/1971	Gould	.....	D7/614
RE27,688 E *	6/1973	White et al.	.....	294/172

D243,832 S *	3/1977	Shveda	.....	D7/507
D293,640 S *	1/1988	Perry et al.	.....	D7/553.6
5,010,461 A *	4/1991	Saotome	.....	362/101
D362,090 S *	9/1995	Baldwin et al.	.....	D30/130
D437,186 S *	2/2001	Asner	.....	D7/544
D438,298 S *	2/2001	McNutt	.....	D23/367
D469,814 S *	2/2003	Wells et al.	.....	D20/29
D488,672 S *	4/2004	Oas	.....	D7/507
D494,417 S *	8/2004	Lee	.....	D7/507
D507,456 S *	7/2005	Hoekstra et al.	.....	D7/505
D566,467 S *	4/2008	Starck	.....	D7/505

\* cited by examiner

*Primary Examiner*—Marianne Pandozzi

(74) *Attorney, Agent, or Firm*—William W. Cochran;  
Cochran Freund & Young LLC

(57) **CLAIM**

The ornamental design for a cup and tray assembly, as shown and described.

**DESCRIPTION**

FIG. 1 is an isometric view of a cup and tray assembly showing our new design.

FIG. 2 is a front view thereof.

FIG. 3 is a top view thereof.

FIG. 4 is a right side view thereof.

FIG. 5 is a left side view thereof.

FIG. 6 is a back view thereof; and,

FIG. 7 is a bottom view thereof.

**1 Claim, 6 Drawing Sheets**

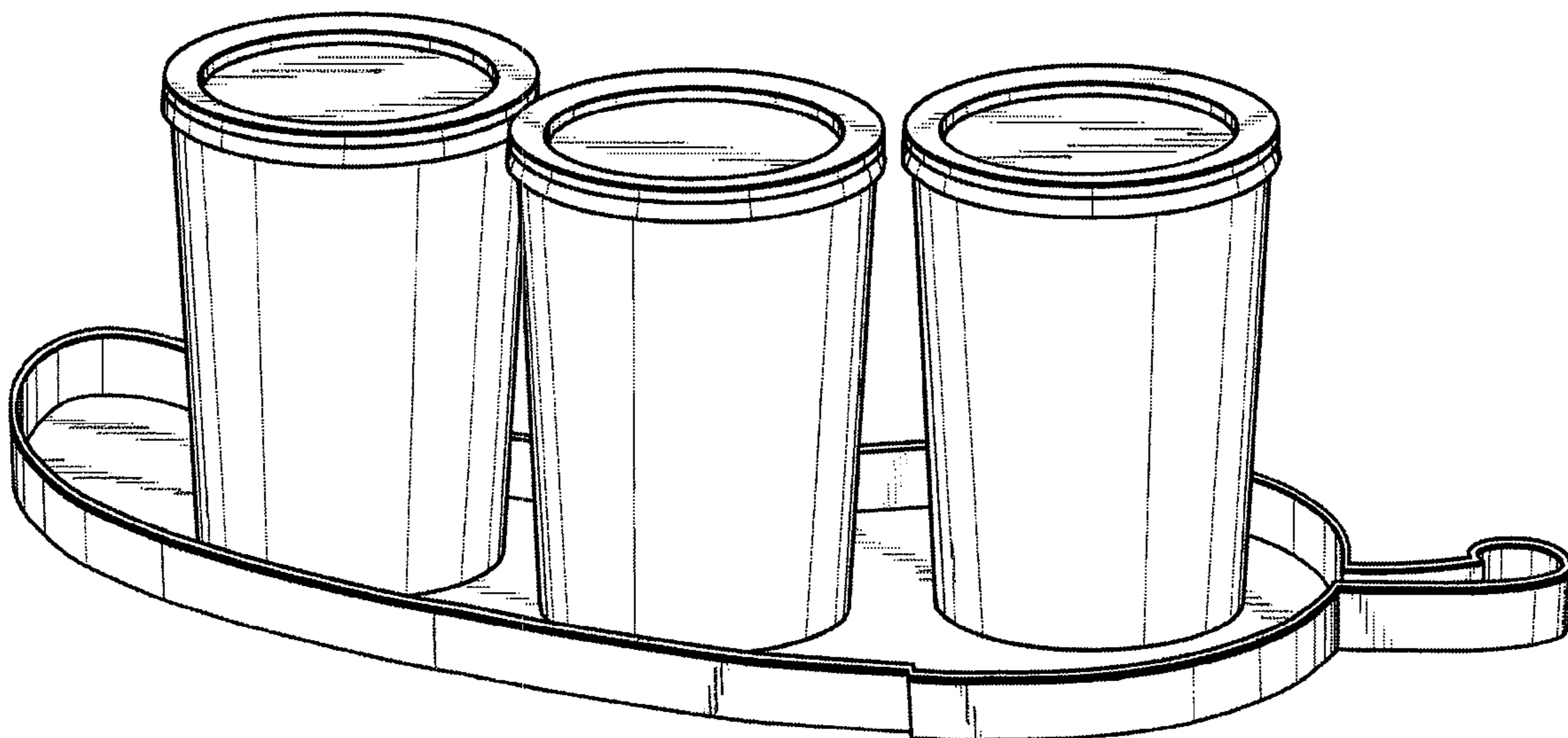

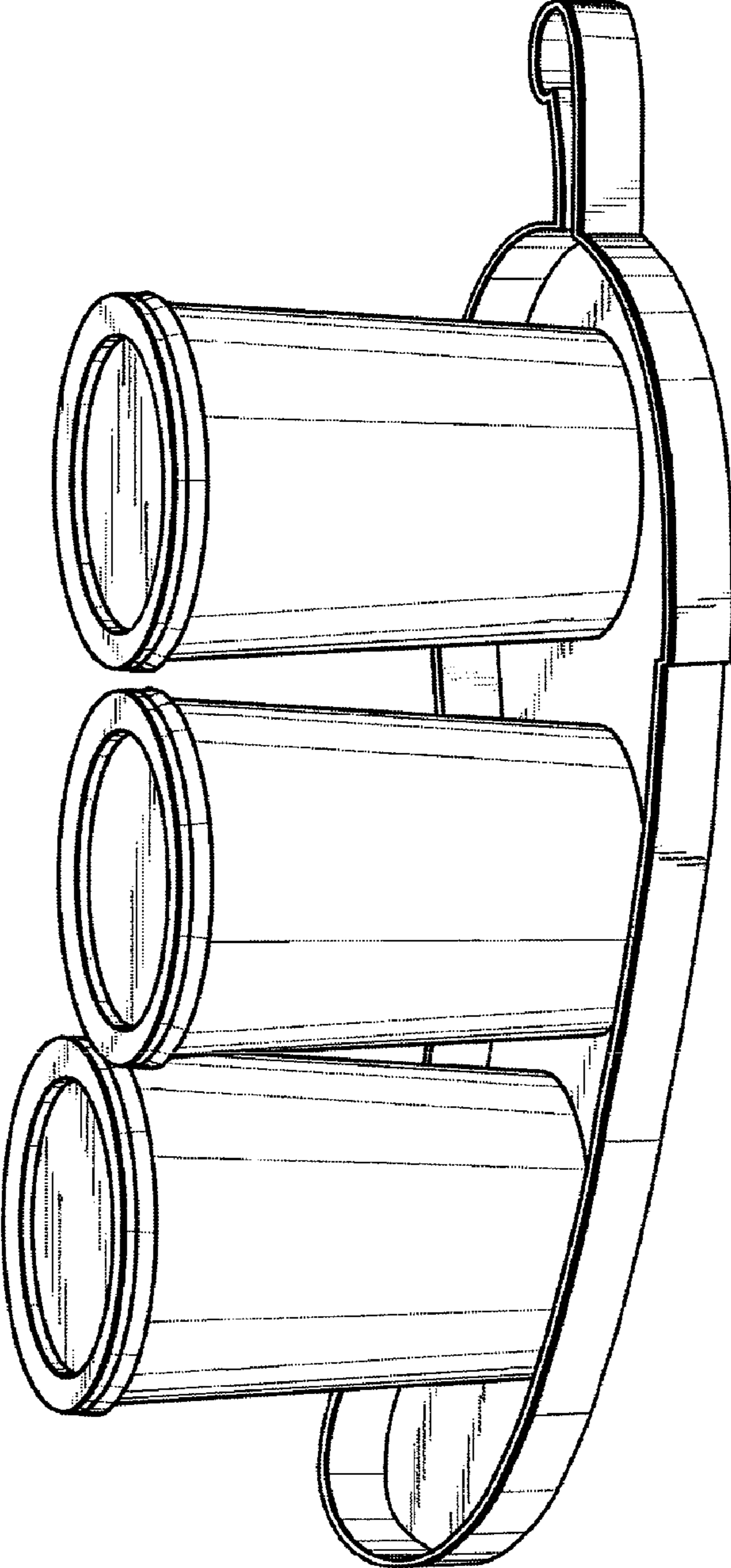

FIG. 1

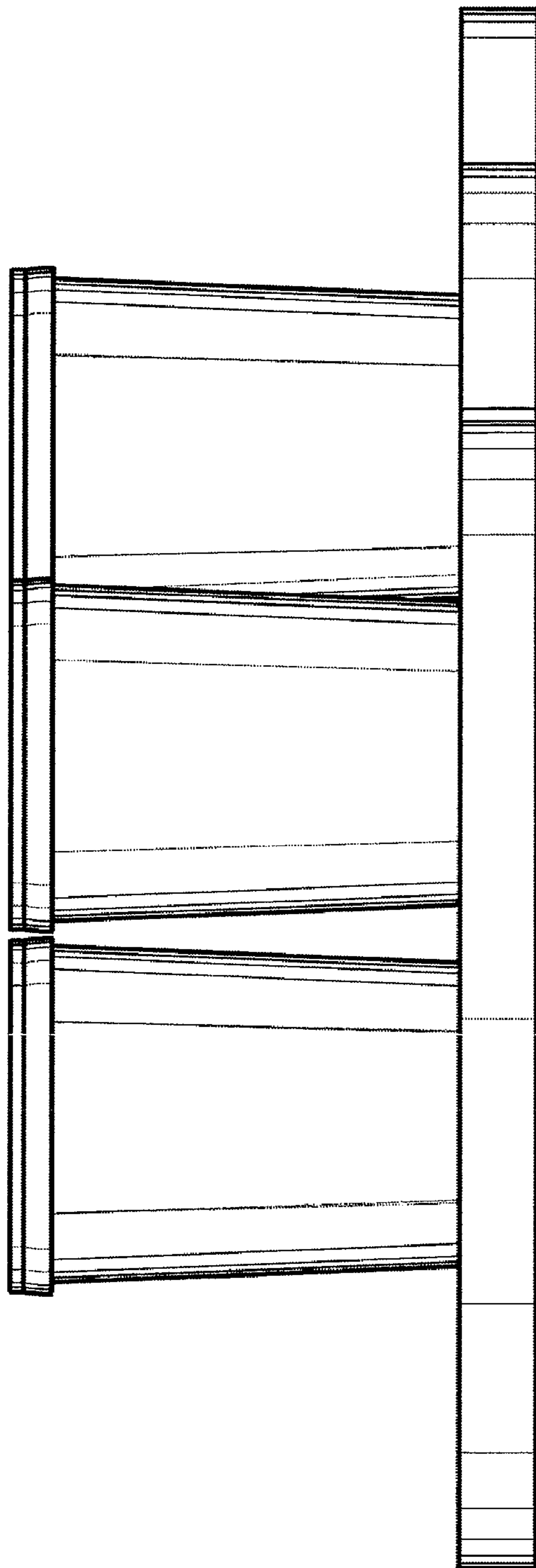

FIG. 2

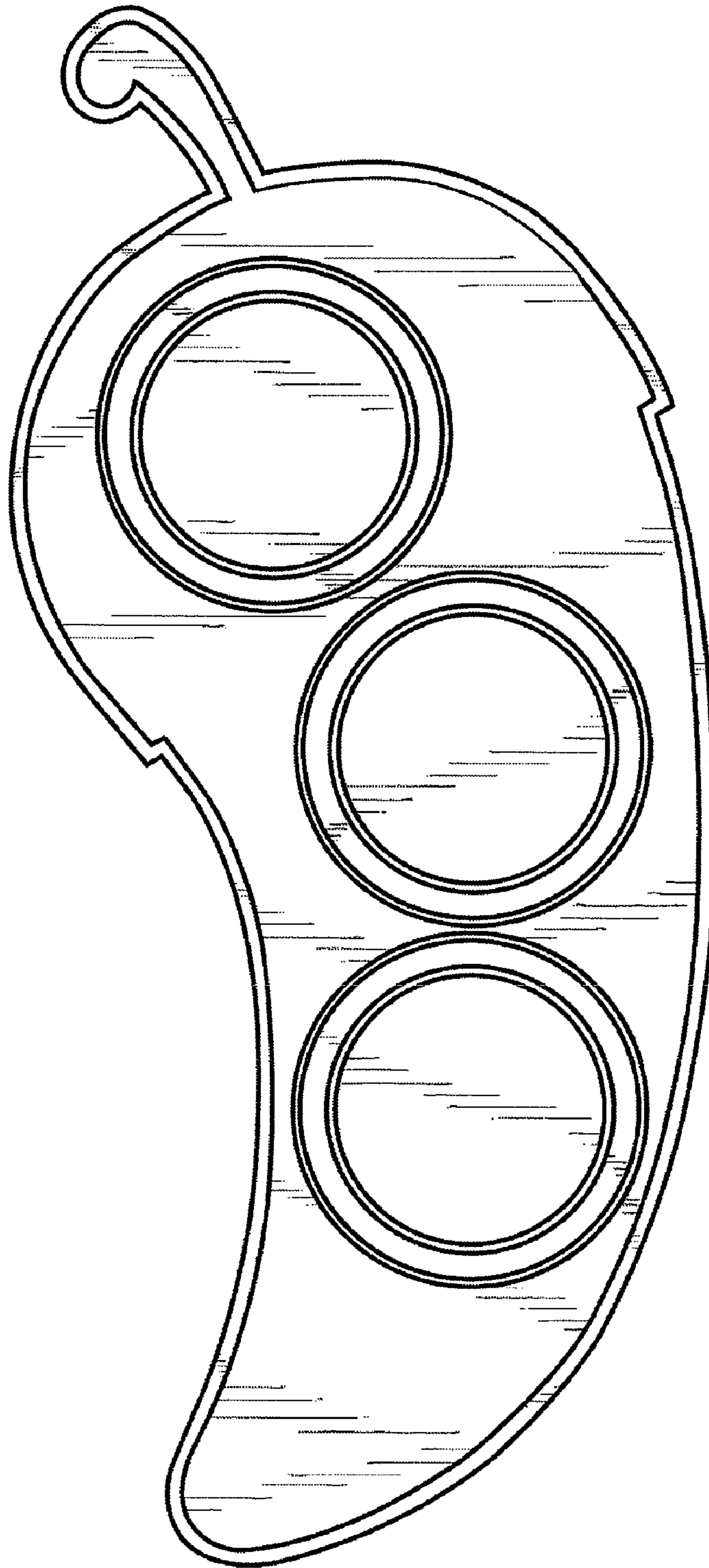

FIG. 3

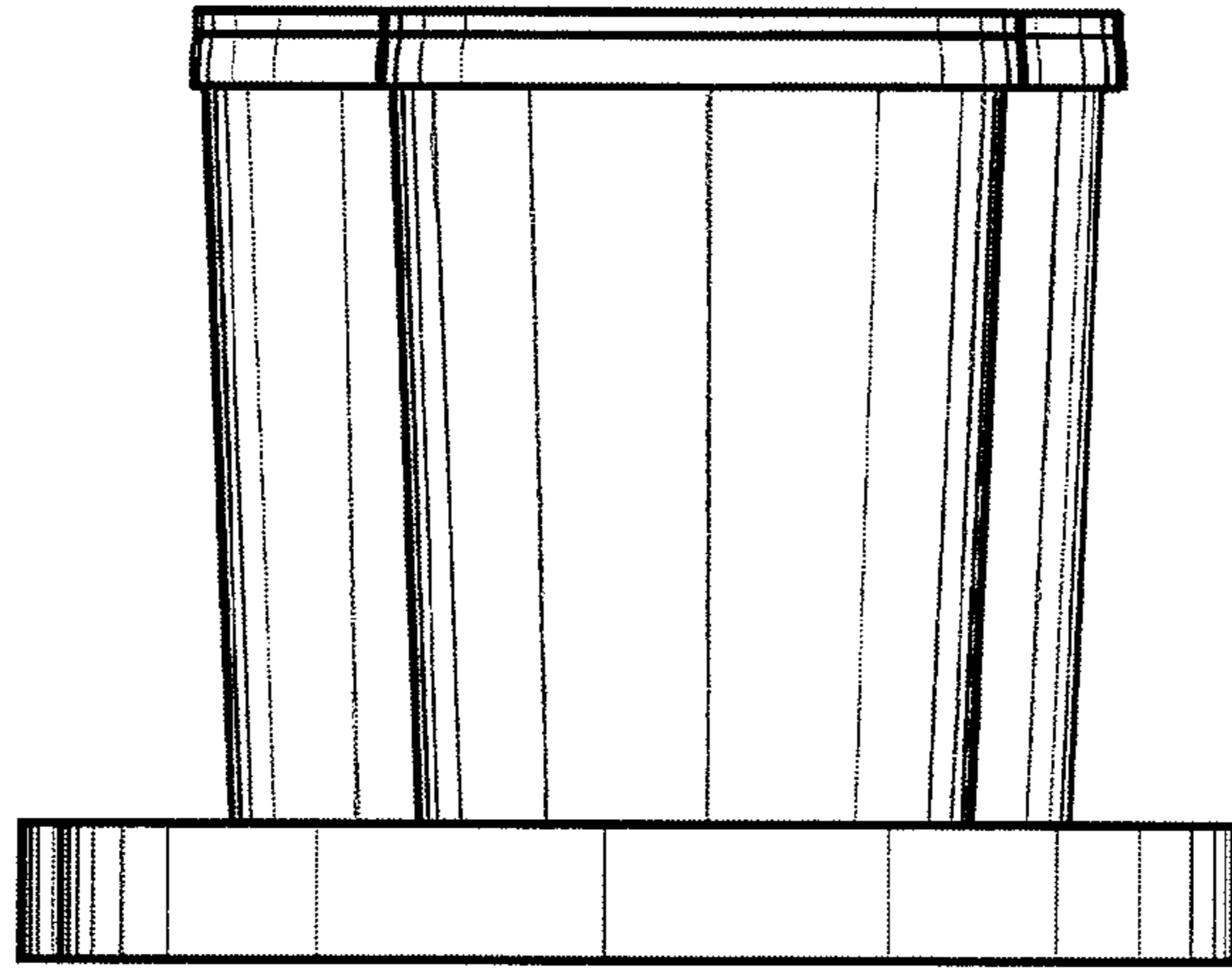

FIG. 4

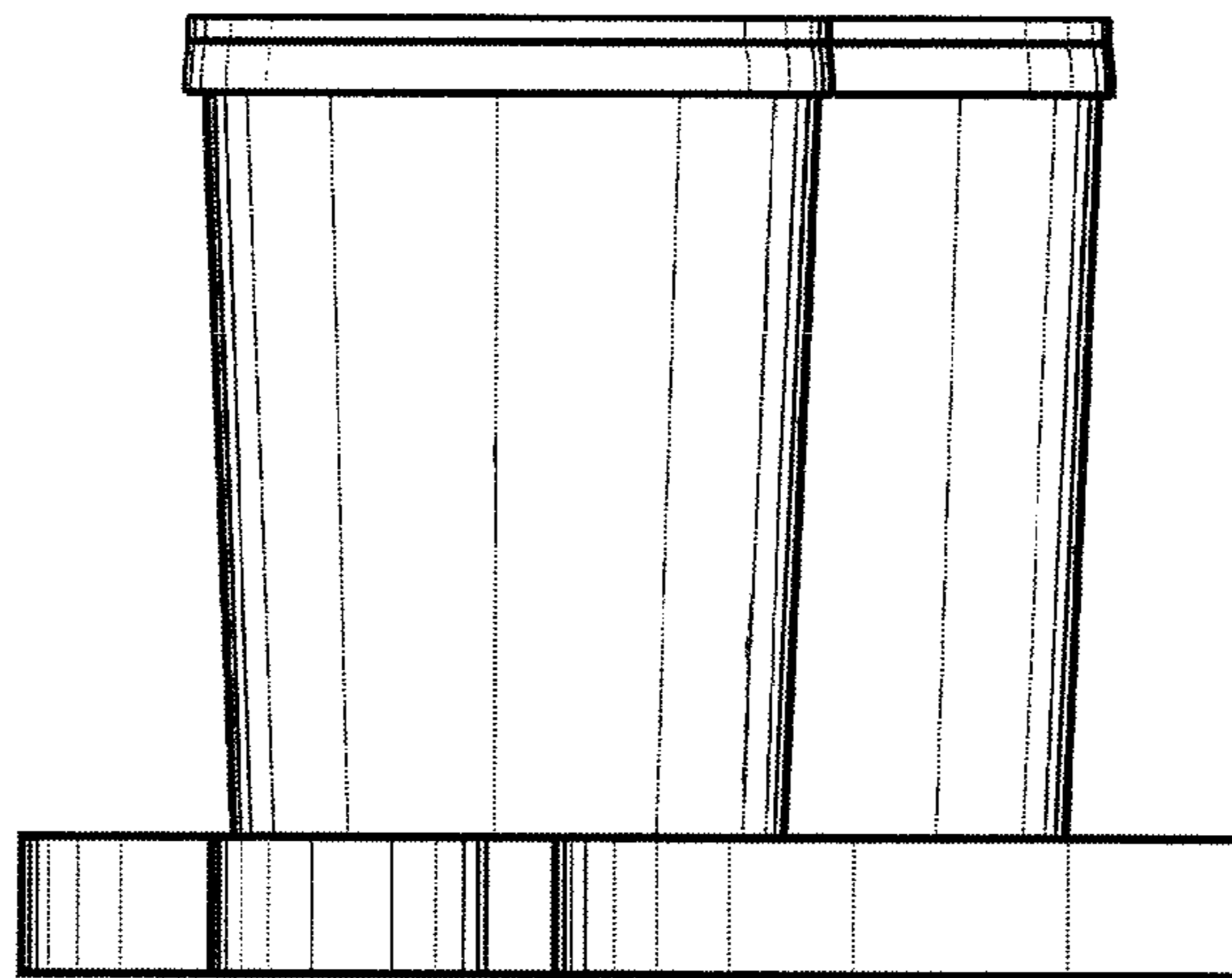

FIG. 5

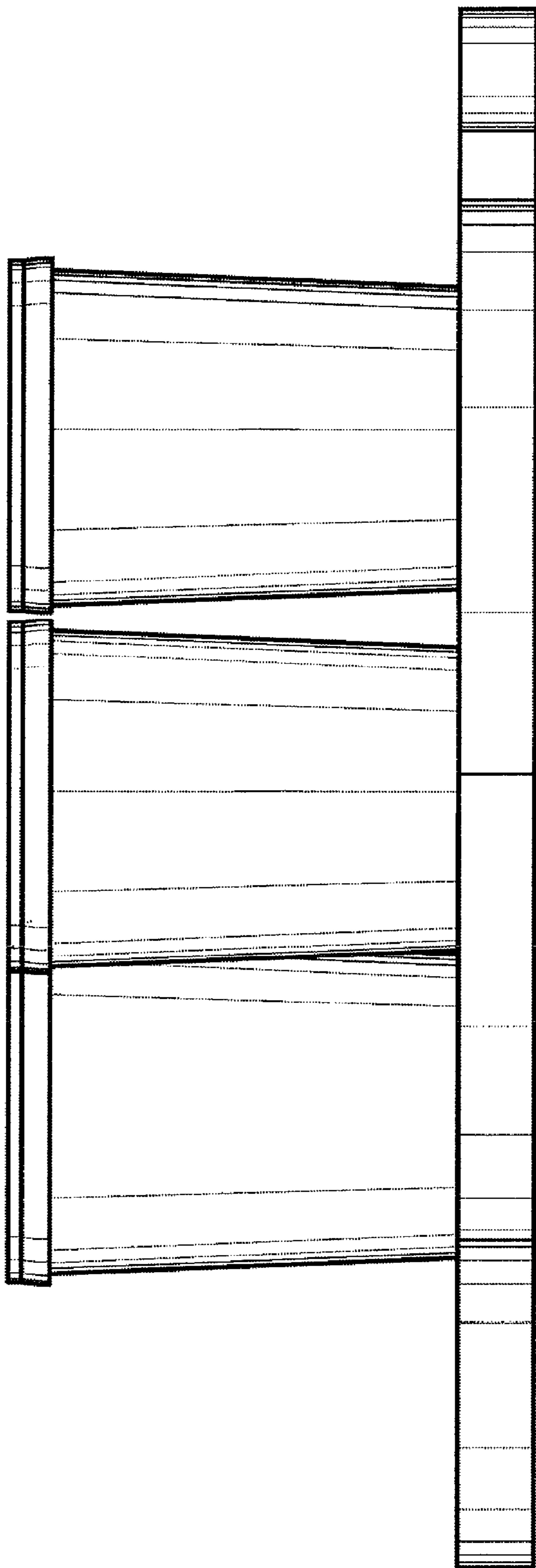

FIG. 6

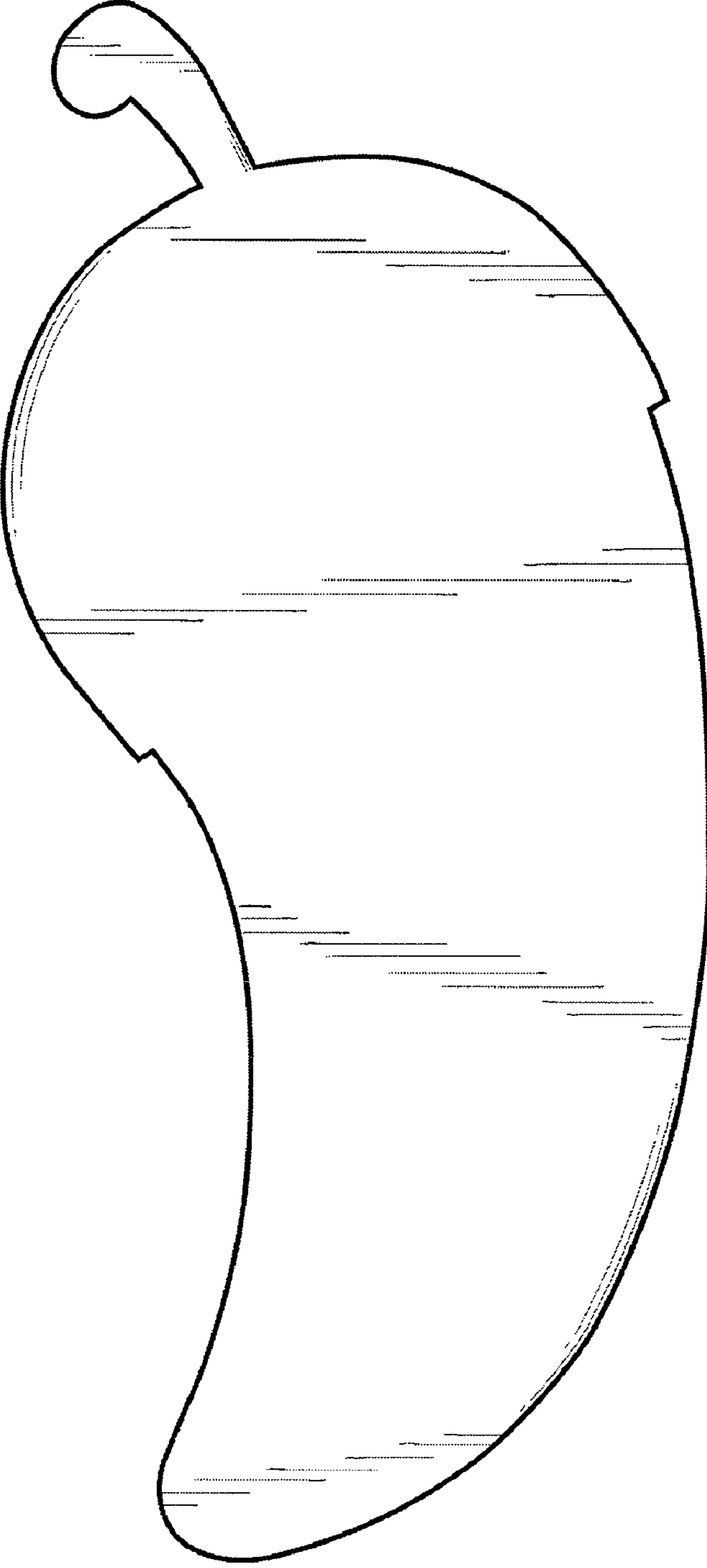

FIG. 7