



US00D583451S

(12) **United States Design Patent**
Aloe et al.

(10) **Patent No.:** **US D583,451 S**
(45) **Date of Patent:** **** Dec. 23, 2008**

(54) **AIR FRESHENER DEVICE**

DESCRIPTION

(75) Inventors: **Valeria Aloe**, Parsippany, NJ (US); **Sam Leach**, Hull (GB); **Jay Packman**, Parsippany, NJ (US); **Simon Woolley**, Hull (GB)

(73) Assignee: **Reckitt Benckiser (UK) Limited**, Berkshire (GB)

(**) Term: **14 Years**

(21) Appl. No.: **29/302,400**

(22) Filed: **Jan. 16, 2008**

(30) **Foreign Application Priority Data**

Jul. 20, 2007 (EM) 000761713-0001

(51) **LOC (8) Cl.** **28-99**

(52) **U.S. Cl.** **D23/366**

(58) **Field of Classification Search** D23/355-369;
261/DIG. 17, DIG. 42, DIG. 65, DIG. 88,
261/DIG. 89; D28/5, 6; 392/386, 390-394,
392/401, 404, 406; 239/34, 35, 41-44, 53-60,
239/136, 326

See application file for complete search history.

(56) **References Cited**

U.S. PATENT DOCUMENTS

913,532 A * 2/1909 Miller 220/23.87

(Continued)

Primary Examiner—Sandra Snapp

(57) **CLAIM**

The ornamental design for an air freshener device, as shown and described.

FIGS. 1-7 represent a first embodiment of the design in which:

FIG. 1 is a perspective view of the top and front of the air freshener device;

FIG. 2 is an elevational view of a first side of the air freshener device;

FIG. 3 is an elevational view of a second side of the air freshener device;

FIG. 4 is an elevational view of a third side of the air freshener device;

FIG. 5 is an elevational view of a fourth side of the air freshener device;

FIG. 6 is a plan view of the top of the air freshener device;

FIG. 7 is a plan view of the bottom of the air freshener device.

FIGS. 8-14 represent a second embodiment of the design in which:

FIG. 8 is a perspective view of the top and front of the air freshener device;

FIG. 9 is an elevational view of a first side of the air freshener device;

FIG. 10 is an elevational view of a second side of the air freshener device;

FIG. 11 is an elevational view of a third side of the air freshener device;

FIG. 12 is an elevational view of a fourth side of the air freshener device;

FIG. 13 is a plan view of the top of the air freshener device; and,

FIG. 14 is a plan view of the bottom of the air freshener device.

The broken lines shown in the drawings are for illustrative purposes only and form no part of the claimed design.

1 Claim, 12 Drawing Sheets

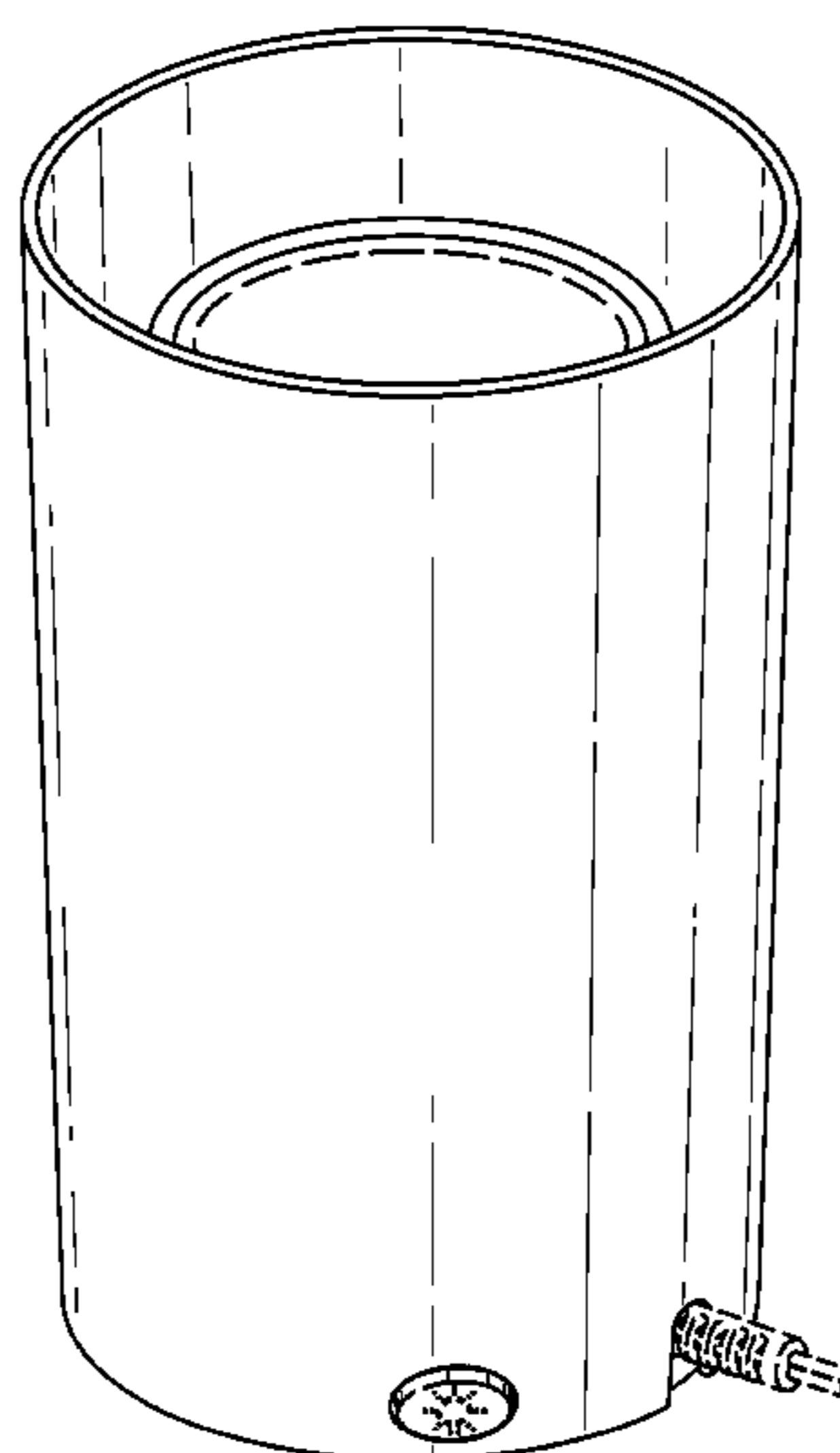

US D583,451 S

Page 2

U.S. PATENT DOCUMENTS

3,781,428	A	*	12/1973	Hennart et al.	514/136	D451,183	S	*	11/2001	Hirano et al.	D23/366
D287,885	S	*	1/1987	Bolduc	D26/11	D454,190	S	*	3/2002	Trocola	D23/366
D288,842	S	*	3/1987	Kwiatkowski	D23/366	6,419,122	B1	*	7/2002	Chown	222/162
D298,592	S	*	11/1988	Stoop	D9/500	D475,445	S	*	6/2003	Kumar	D23/366
6,050,551	A	*	4/2000	Anderson	261/30	D509,893	S	*	9/2005	Sevy	D23/366
D449,371	S	*	10/2001	Bornstein et al.	D23/360	D535,376	S	*	1/2007	Michaels et al.	D23/366
D449,877	S	*	10/2001	Delmenico et al.	D23/356						

* cited by examiner

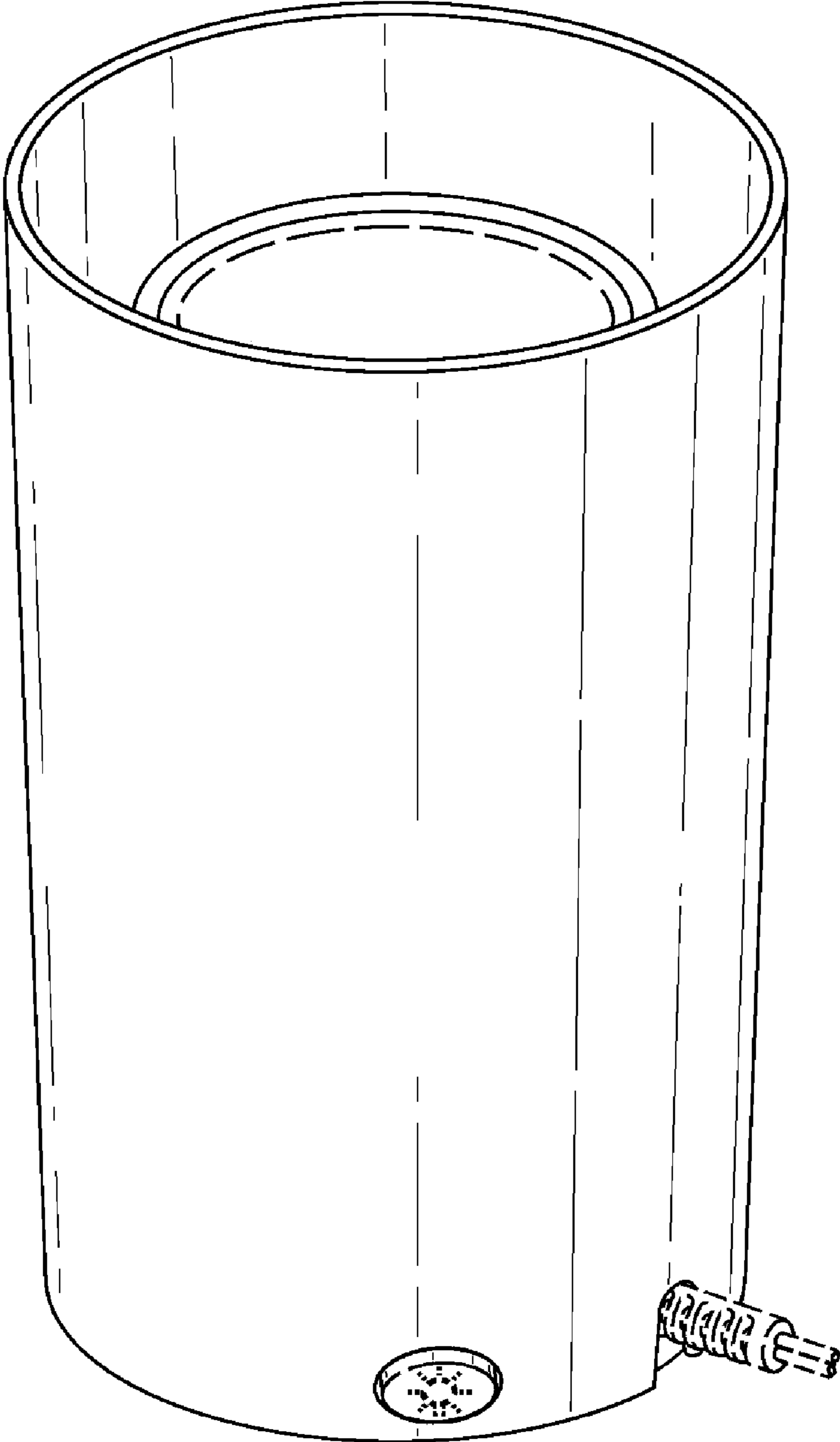

Fig. 1.

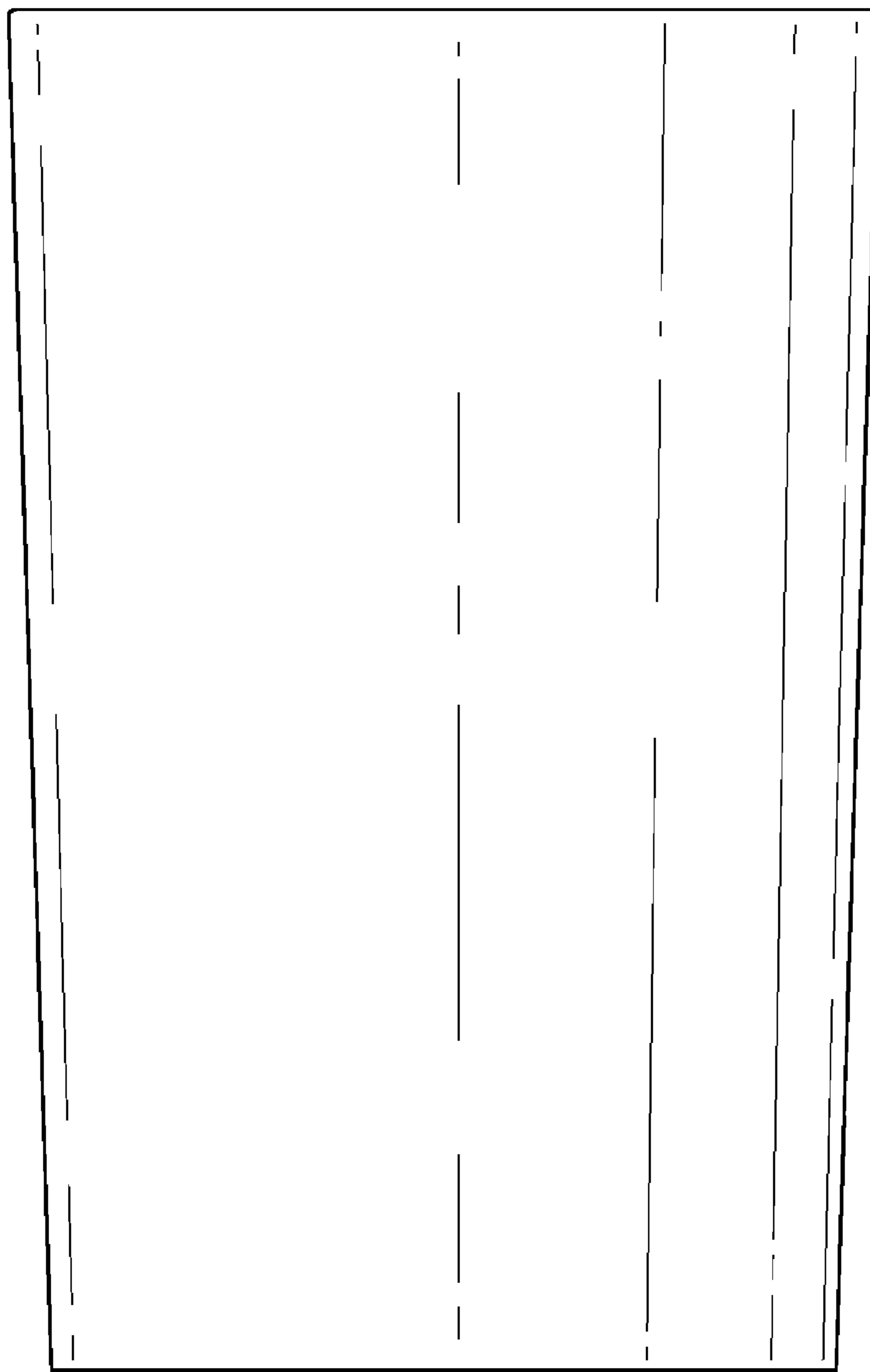

Fig.2.

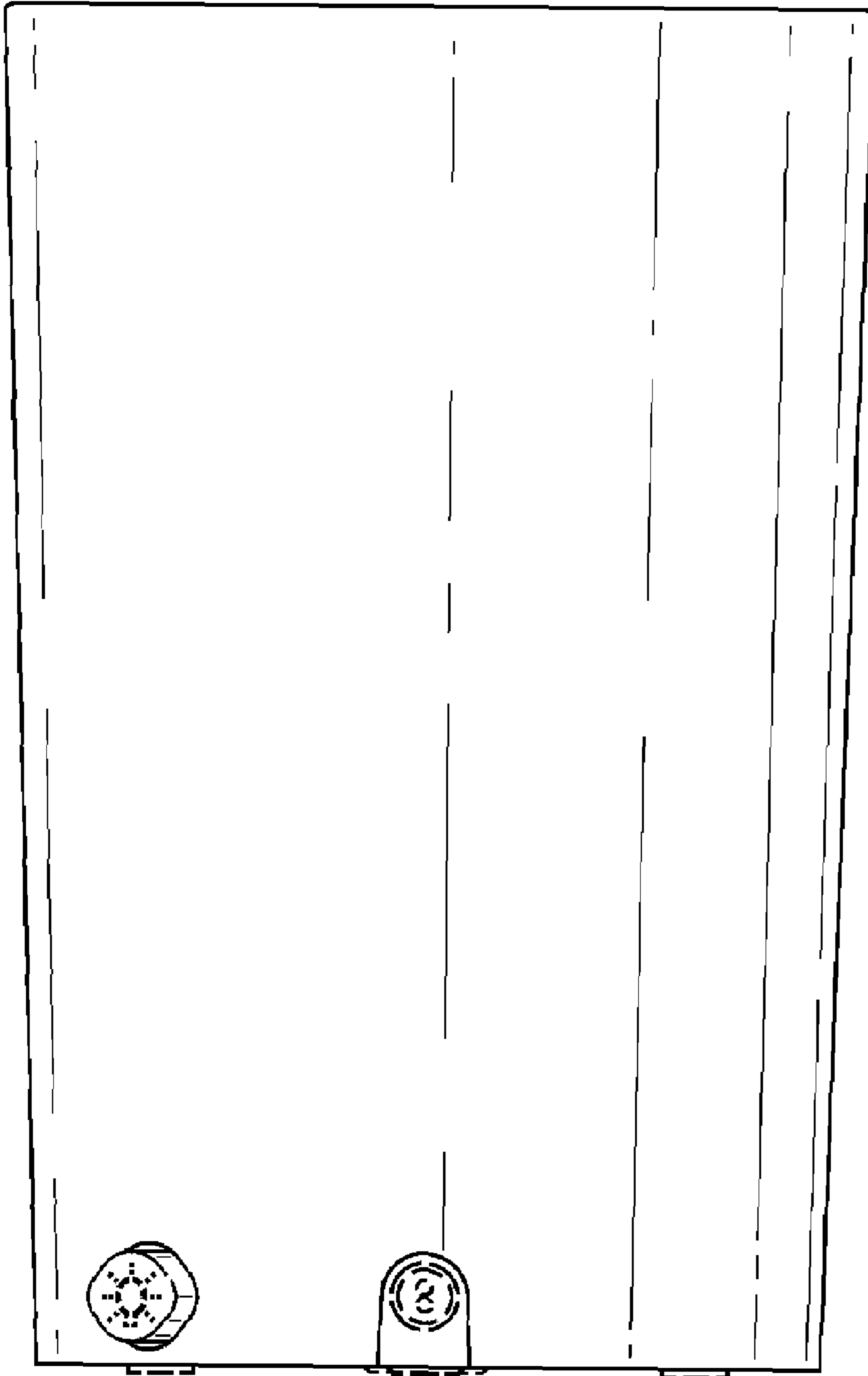

Fig.3.

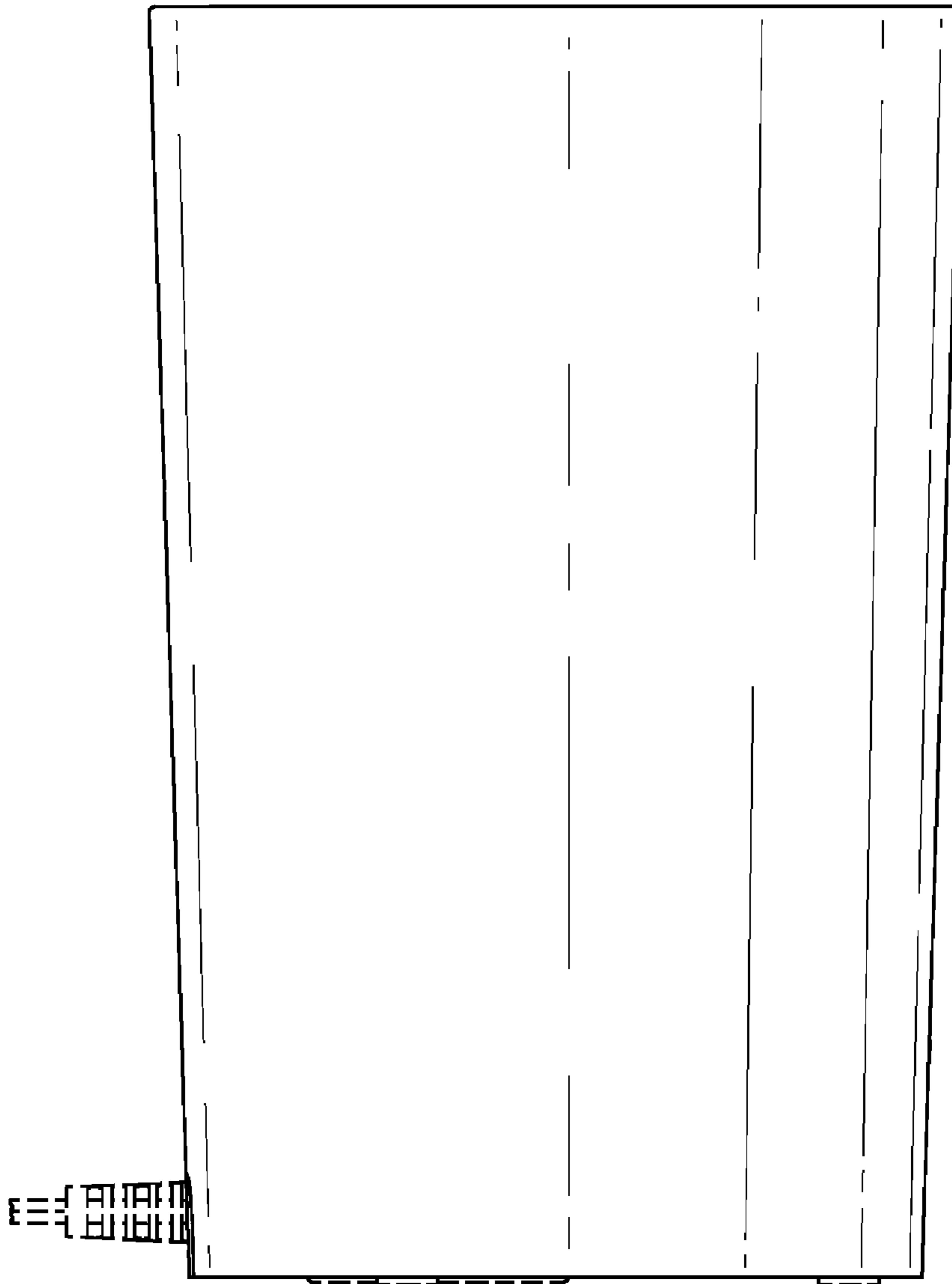

Fig.4.

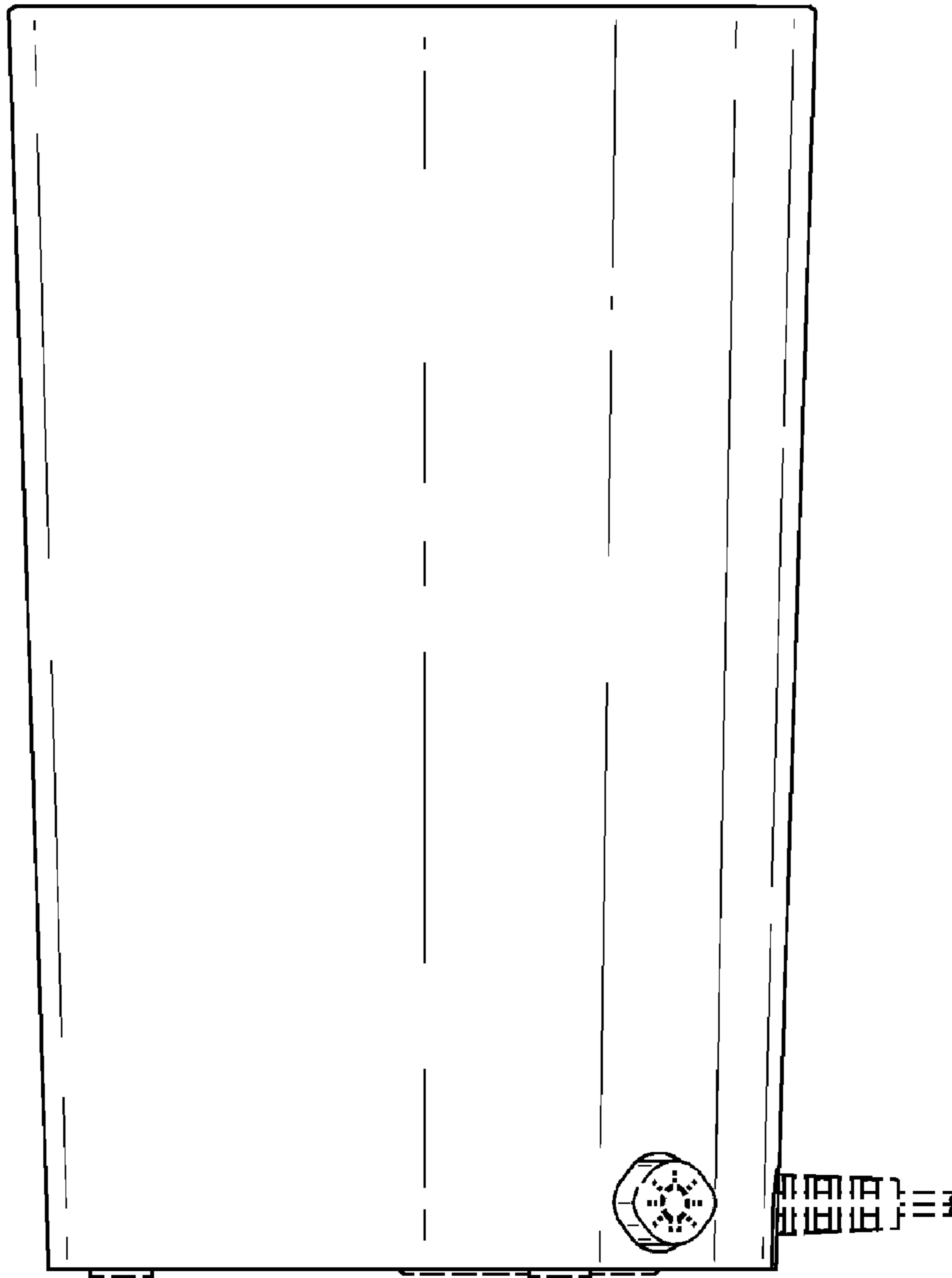

Fig.5.

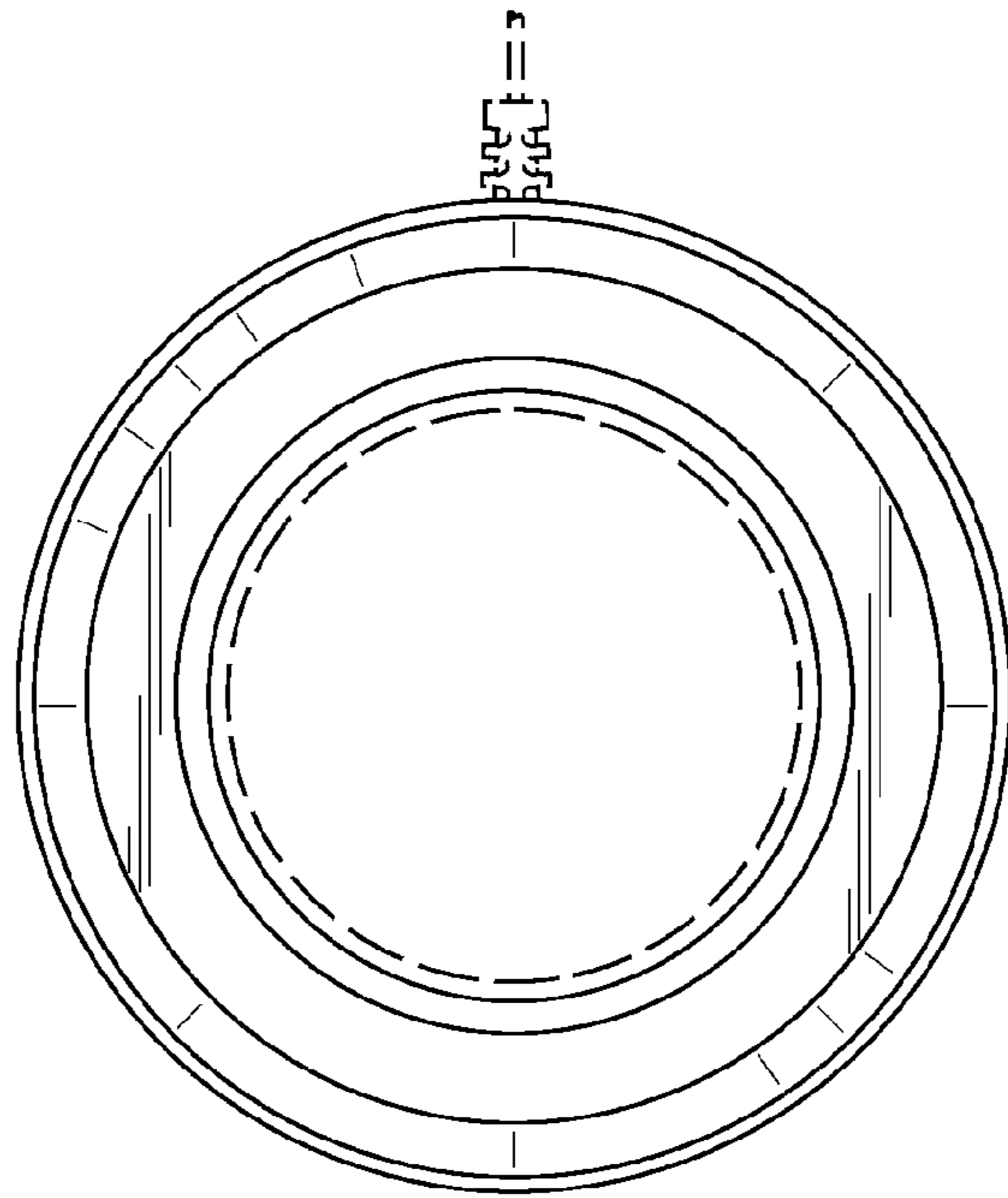

Fig.6.

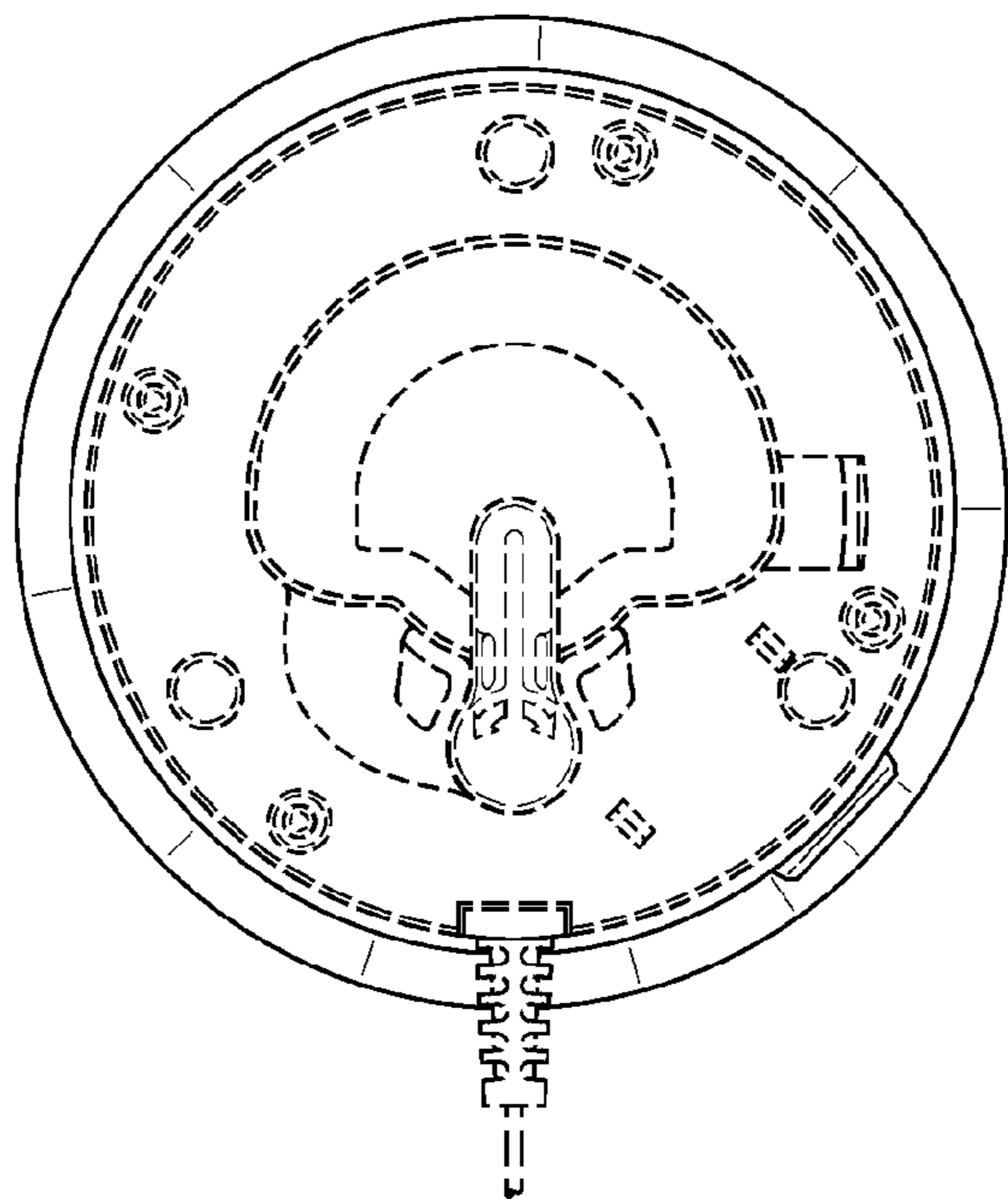

Fig.7.

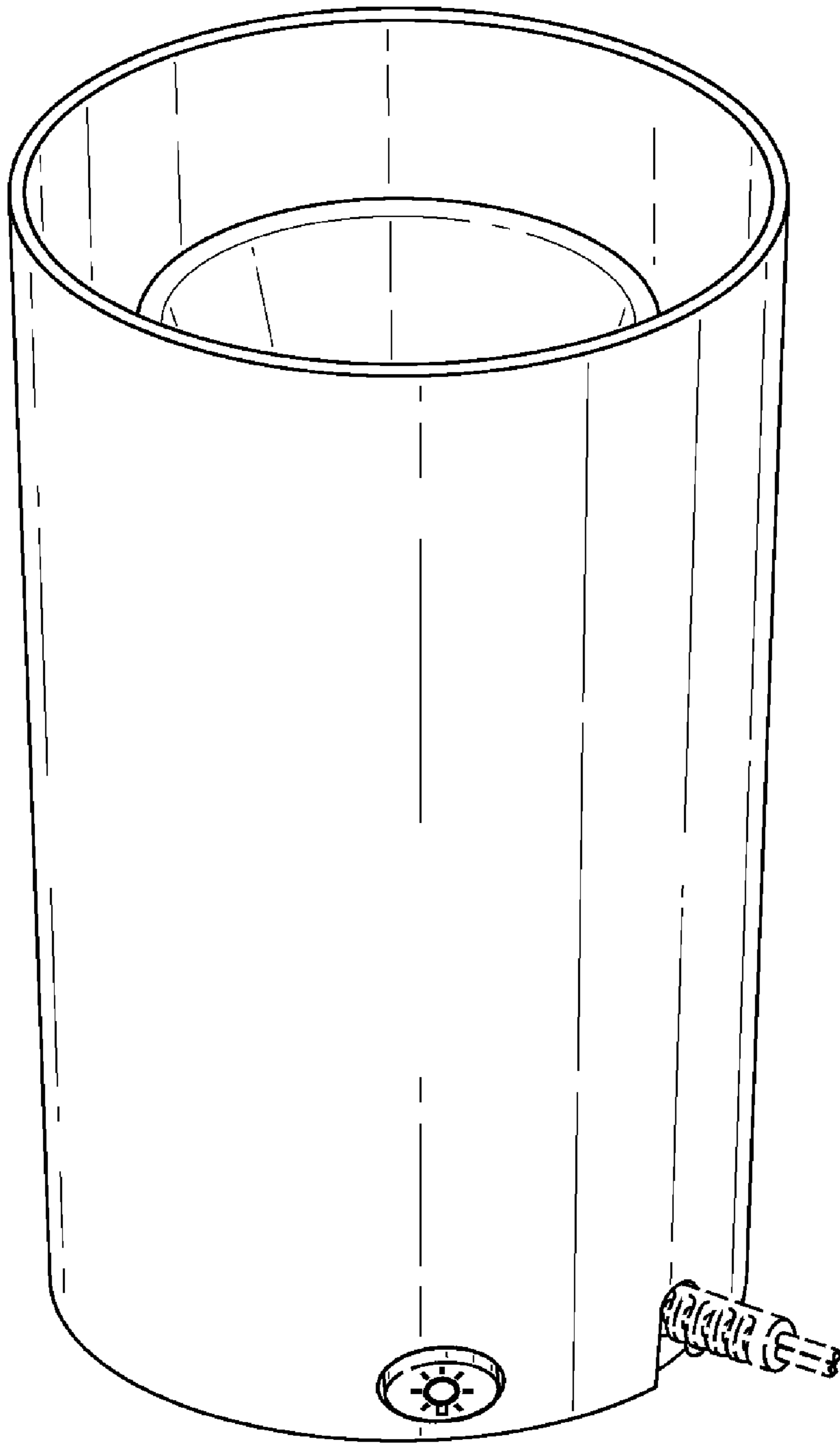

Fig.8.

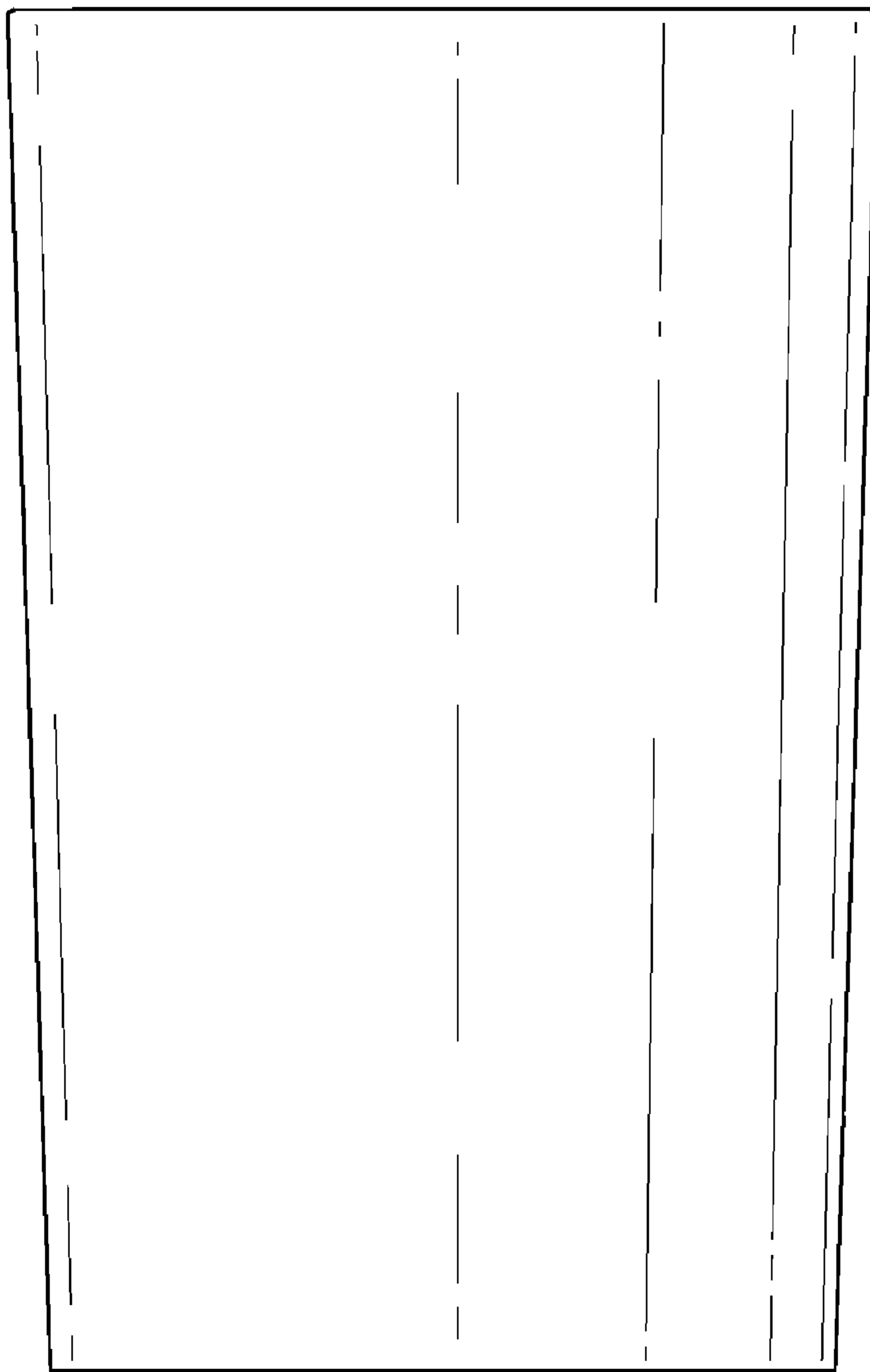

Fig.9.

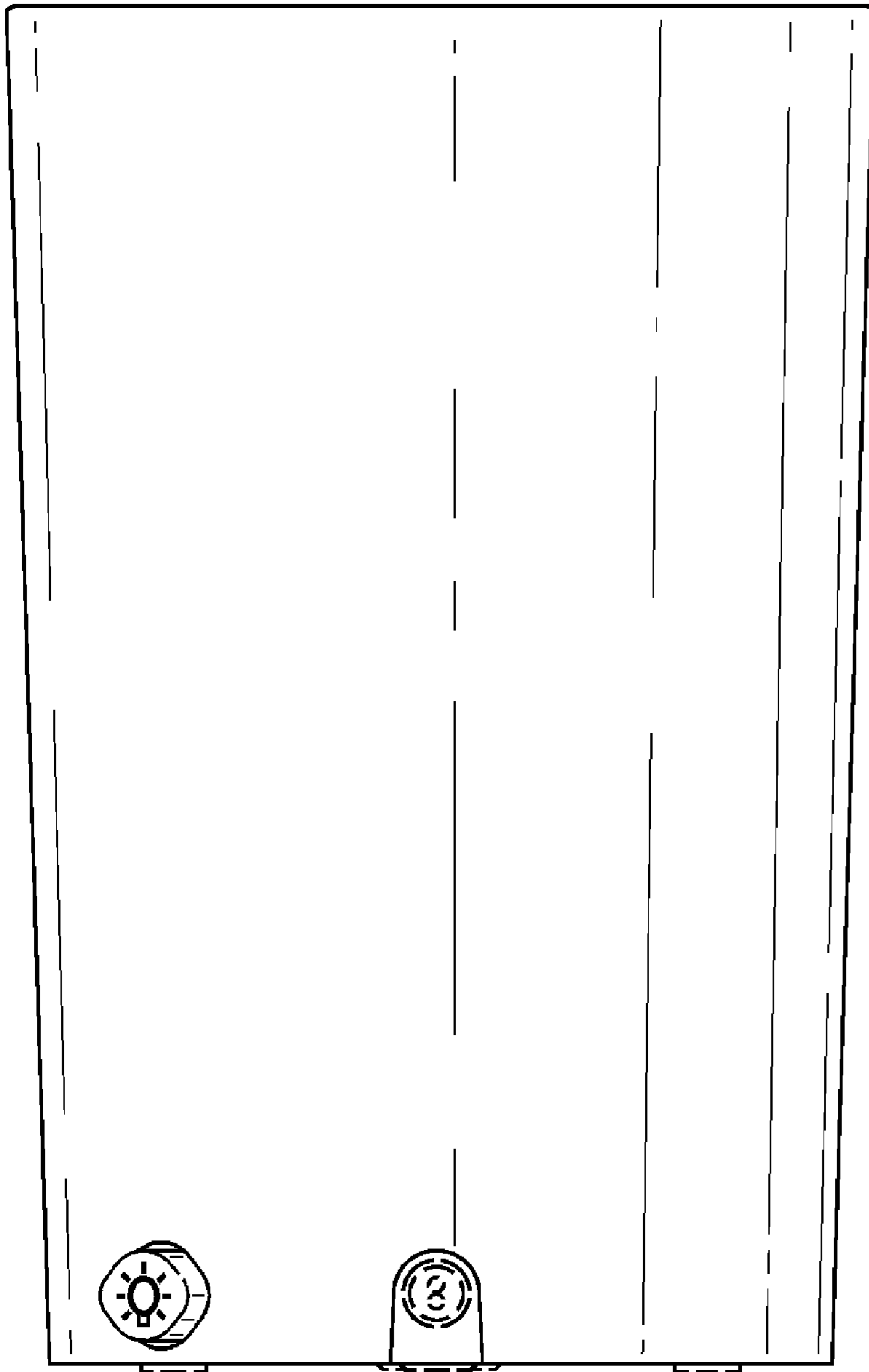

Fig. 10.

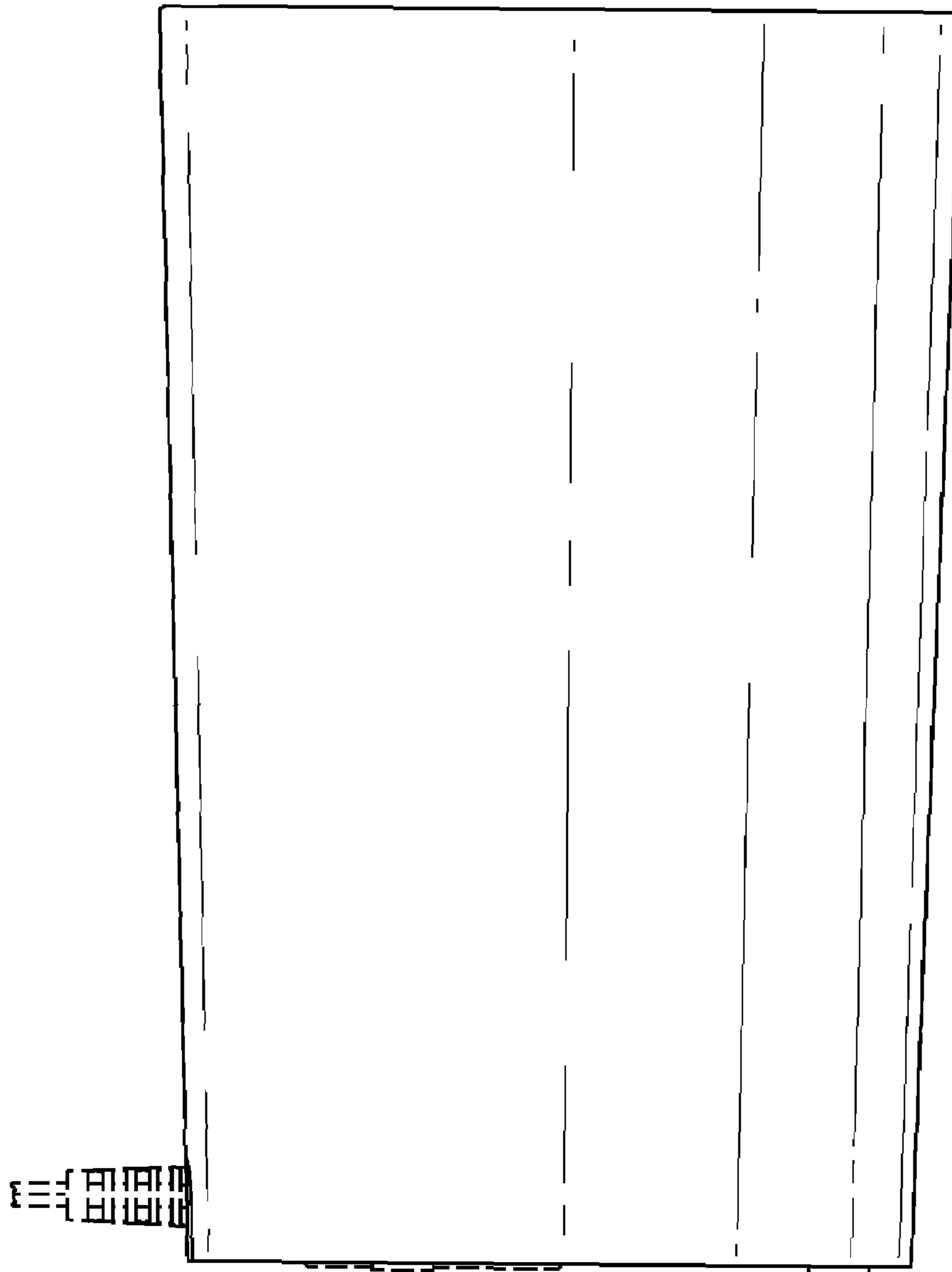

Fig.11.

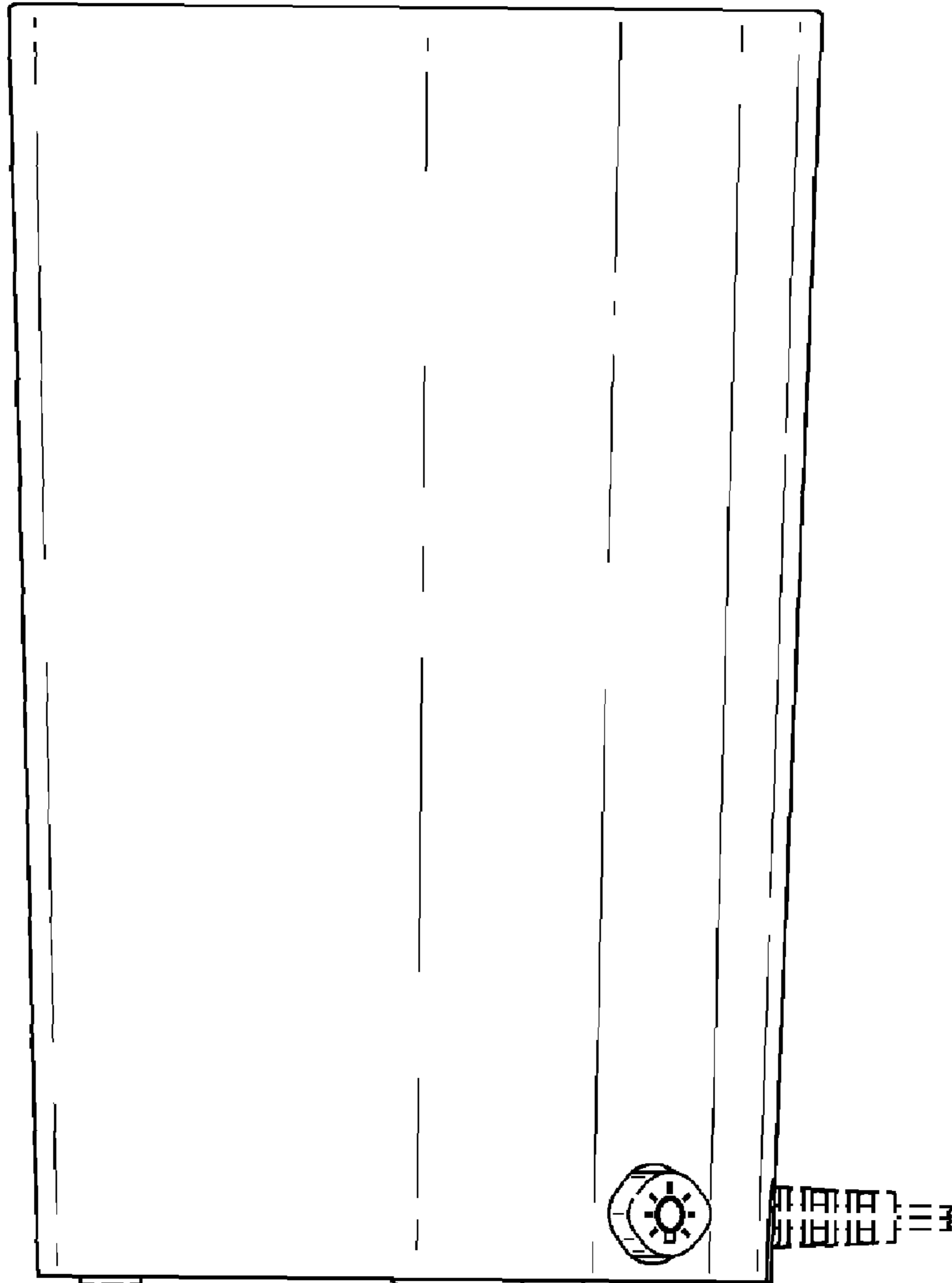

Fig. 12.

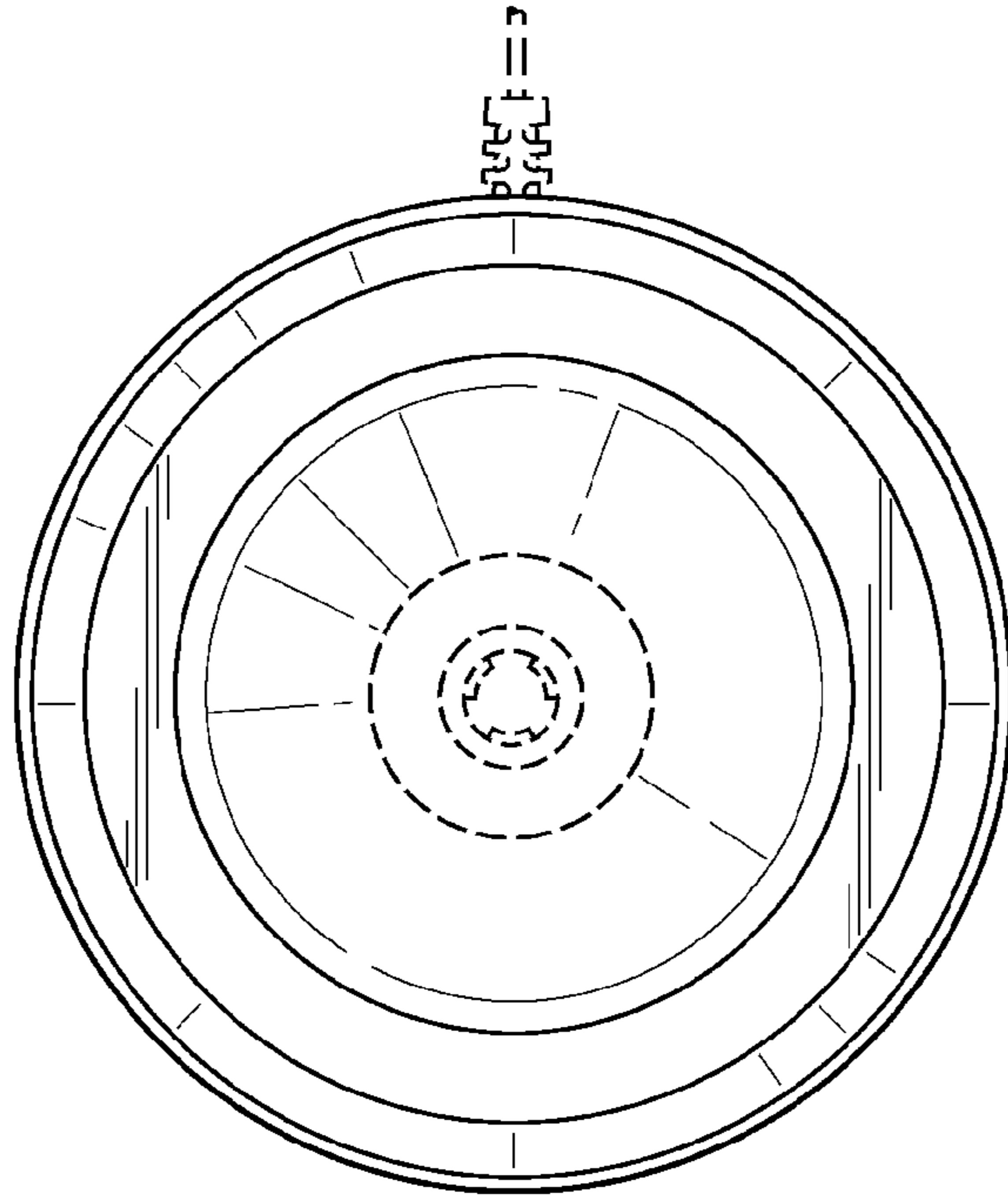

Fig. 13.

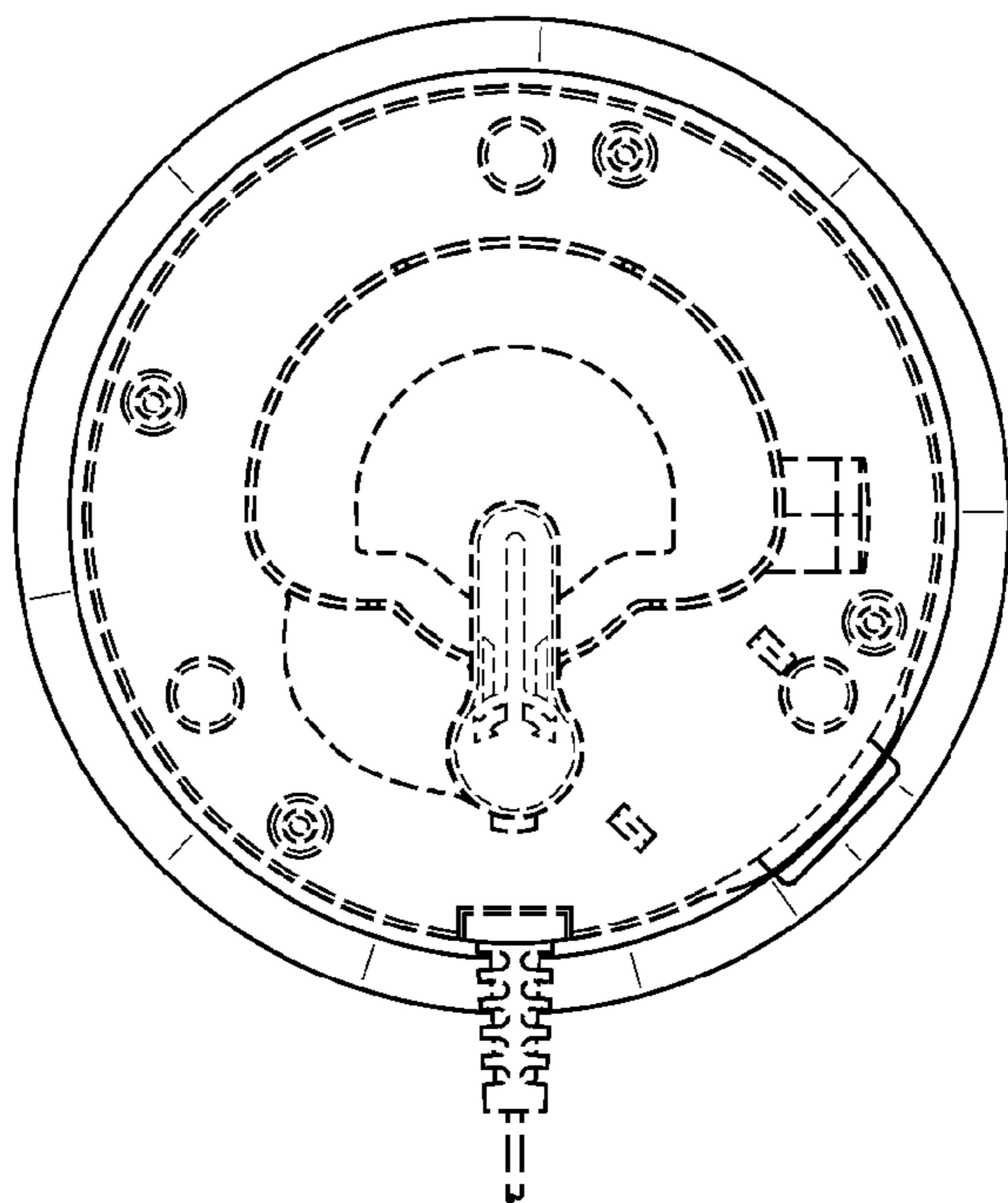

Fig. 14.