



US00D583345S

(12) **United States Design Patent**  
**Kim et al.**

(10) **Patent No.:** **US D583,345 S**  
(45) **Date of Patent:** **\*\* Dec. 23, 2008**

(54) **MOBILE PHONE**

D545,294 S \* 6/2007 Hwang ..... D14/138  
D556,211 S \* 11/2007 Howard ..... D14/496

(75) Inventors: **Young-Sae Kim**, Palo Alto, CA (US);  
**Ji-Eun Lee**, Seoul (KR); **Young-Ju Yeo**,  
Seoul (KR); **Chang-Soo Lee**, Incheon  
(KR)

(Continued)

**FOREIGN PATENT DOCUMENTS**

TW D118703 8/2007  
TW D123852 7/2008

(73) Assignee: **Samsung Electronics Co., Ltd.**,  
Suwon-Si (KR)

**OTHER PUBLICATIONS**

LG V9000, announced Feb. 2006, [online], [retrieved on Feb. 20,  
2007]. Retrieved from Internet ,<URL: <http://www.gsmarena.com>>.\*

(\*\*) Term: **14 Years**

(Continued)

(21) Appl. No.: **29/300,303**

*Primary Examiner*—Jeffrey D Asch  
*Assistant Examiner*—Bridget L Eland  
(74) *Attorney, Agent, or Firm*—Staas & Halsey LLP

(22) Filed: **Mar. 10, 2008**

(30) **Foreign Application Priority Data**

Nov. 2, 2007 (KR) ..... 30-2007-0045686

(57) **CLAIM**

(51) **LOC (8) Cl.** ..... **14-03**

The ornamental design for a mobile phone, as shown and described.

(52) **U.S. Cl.** ..... **D14/138 AD; D14/138 AC**

(58) **Field of Classification Search** ..... D14/137,  
D14/138, 147, 191, 218, 247–248, 341–347,  
D14/496; D10/65, 78, 104; D13/168; D18/7;  
455/556.1, 566, 575.1, 575.3; 345/169  
See application file for complete search history.

**DESCRIPTION**

FIG. 1 is a perspective view of a mobile phone;  
FIG. 2 is a front view of the mobile phone of FIG. 1;  
FIG. 3 is a rear view of the mobile phone of FIG. 1;  
FIG. 4 is a left-side view of the mobile phone of FIG. 1;  
FIG. 5 is a right-side view of the mobile phone of FIG. 1;  
FIG. 6 is a top plan view of the mobile phone of FIG. 1;  
FIG. 7 is a bottom plan view of the mobile phone of FIG. 1;  
FIG. 8 is an open perspective view of the mobile phone of  
FIG. 1 in an in-use condition; and,  
FIG. 9 is another open perspective view of the mobile phone  
of FIG. 1 in an in-use condition.

(56) **References Cited**

**U.S. PATENT DOCUMENTS**

D319,433 S \* 8/1991 Pearce ..... D14/341  
D360,195 S \* 7/1995 Kimbrough et al. .... D14/342  
6,636,204 B2 \* 10/2003 Santoh ..... 345/179  
D506,937 S \* 7/2005 Lee et al. .... D10/65  
D519,116 S \* 4/2006 Tanaka et al. .... D14/341  
D525,609 S \* 7/2006 Kim et al. .... D14/138  
D532,791 S \* 11/2006 Kim ..... D14/496  
D541,782 S \* 5/2007 Kim et al. .... D14/138  
D541,785 S \* 5/2007 Hwang et al. .... D14/138  
D545,293 S \* 6/2007 Hwang ..... D14/138

**1 Claim, 7 Drawing Sheets**

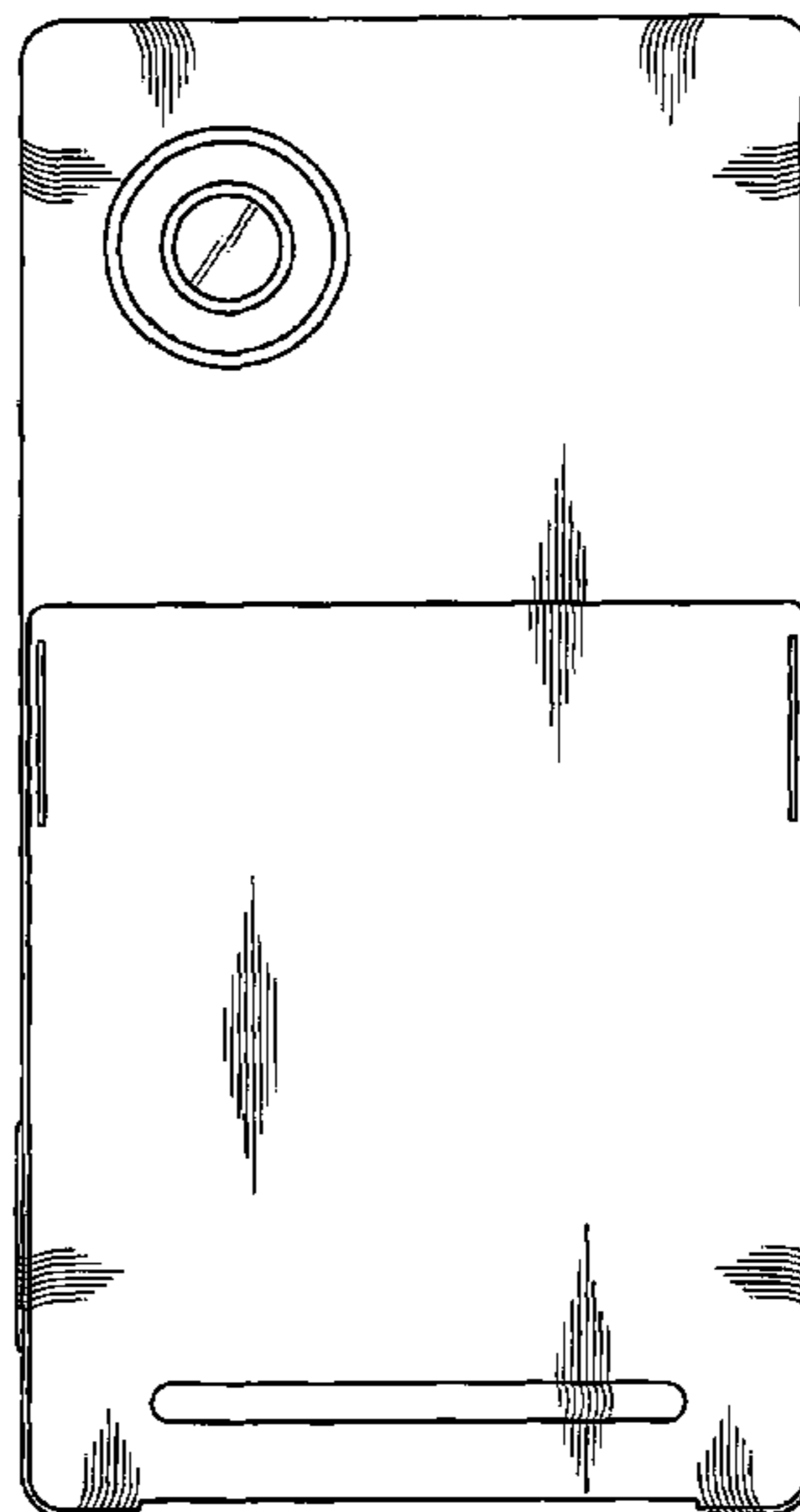
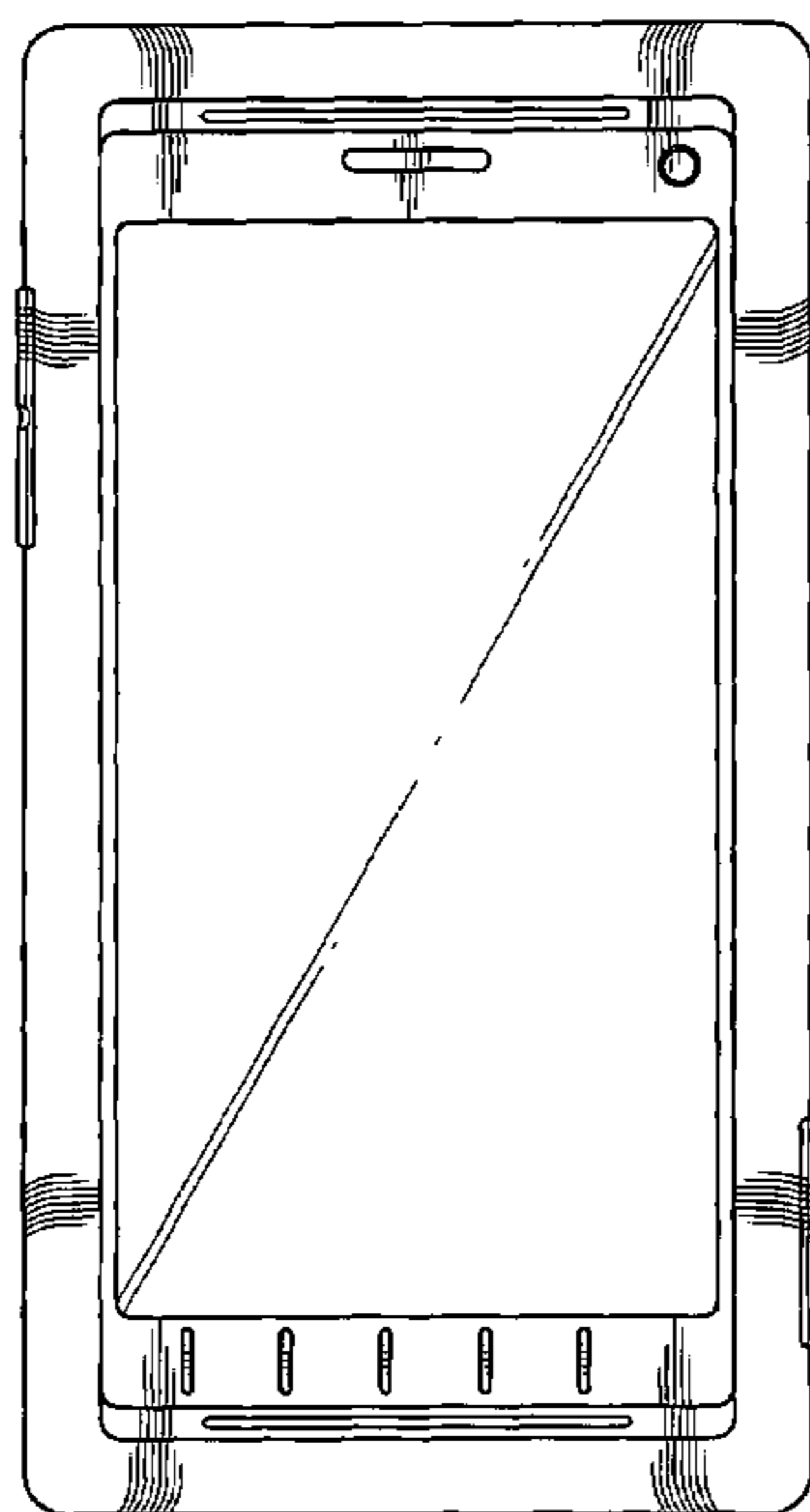

U.S. PATENT DOCUMENTS

D558,720	S *	1/2008	Lee et al. ....	D14/138
D562,285	S *	2/2008	Lim .....	D14/138
D562,292	S *	2/2008	Park .....	D14/138
D562,795	S *	2/2008	Nara .....	D14/138
D563,807	S *	3/2008	Jeon .....	D10/65
D565,978	S *	4/2008	Stevens et al. ....	D10/65
D569,837	S *	5/2008	Baik et al. ....	D14/138
7,369,882	B2 *	5/2008	Hwang et al. ....	455/575.1
D572,227	S *	7/2008	Yoon et al. ....	D14/138
D573,143	S *	7/2008	Park et al. ....	D14/341
D575,259	S *	8/2008	Kim et al. ....	D14/138
D575,760	S *	8/2008	Kim et al. ....	D14/138
7,411,627	B2 *	8/2008	Jeong et al. ....	348/374
2007/0273786	A1 *	11/2007	Ahn et al. ....	348/373

OTHER PUBLICATIONS

LG KE850 Prada, announced Jan. 2007, [online], [retrieved on Feb. 20, 2007 and May 18, 2007]. Retrieved from Internet ,<URL: <http://www.gsmarena.com>>.\*

LG KU990 Viewty, announced Aug. 2007, [online], [retrieved on Sep. 15, 2007]. Retrieved from Internet ,<URL: <http://www.gsmarena.com>>.\*

LG KF700, announced Feb. 2008, [online], [retrieved on Mar. 21, 2008]. Retrieved from Internet, <URL: <http://www.gsmarena.com>>.\*

LG CU915 Vu, announced Mar. 2008, [online], [retrieved on May 14, 2008]. Retrieved from Internet ,<URL: <http://www.gsmarena.com>>.\*

LG KC910, announced Aug. 2008, [online], [retrieved on Aug. 22, 2008]. Retrieved from Internet ,<URL: <http://www.gsmarena.com>>.\*

Samsung F490, announced Jan. 2008, [online], [retrieved on Jan. 18, 2008]. Retrieved from Internet ,<URL: <http://www.gsmarena.com>>.\*

Taiwanese Patent Office Action, mailed Aug. 20, 2008 and issued in corresponding Taiwanese Design Patent Application No. 096307114.

\* cited by examiner

FIG. 1

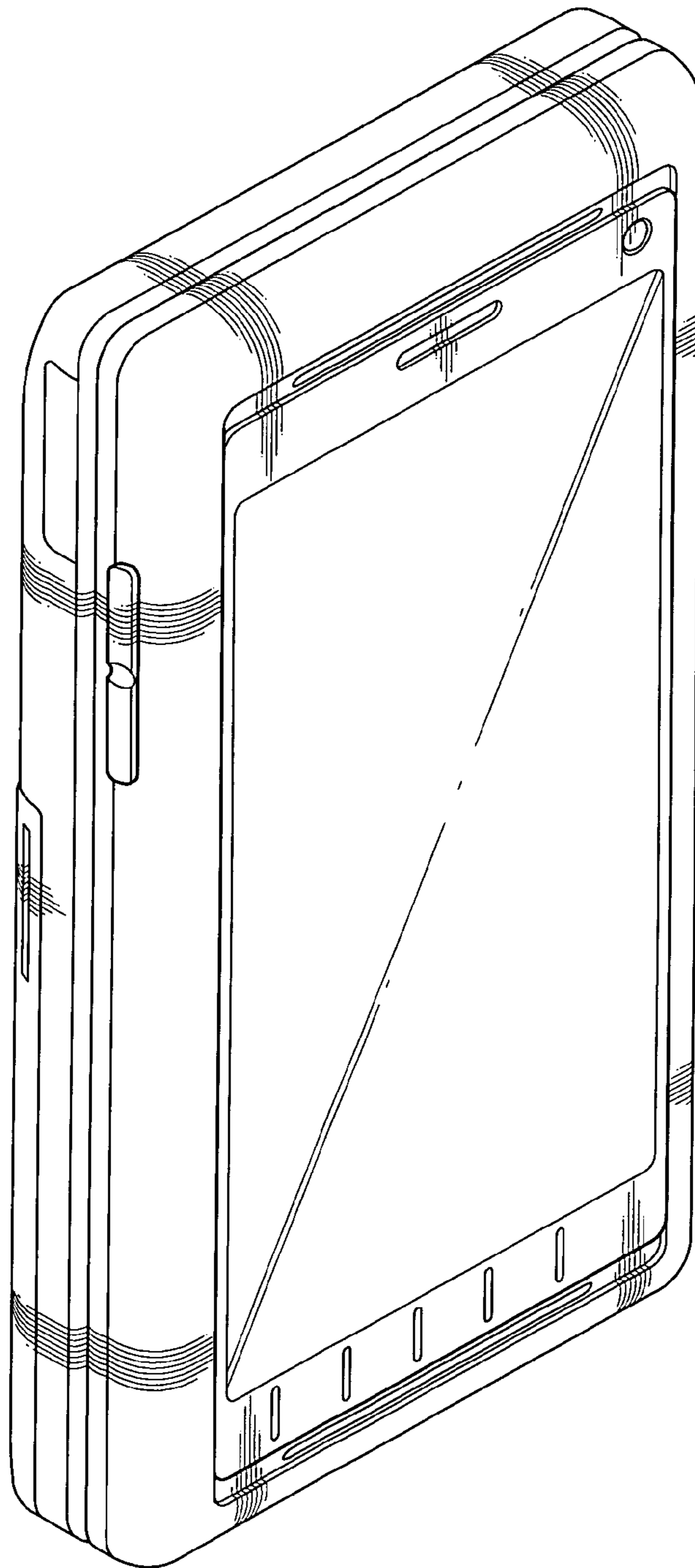

FIG. 2

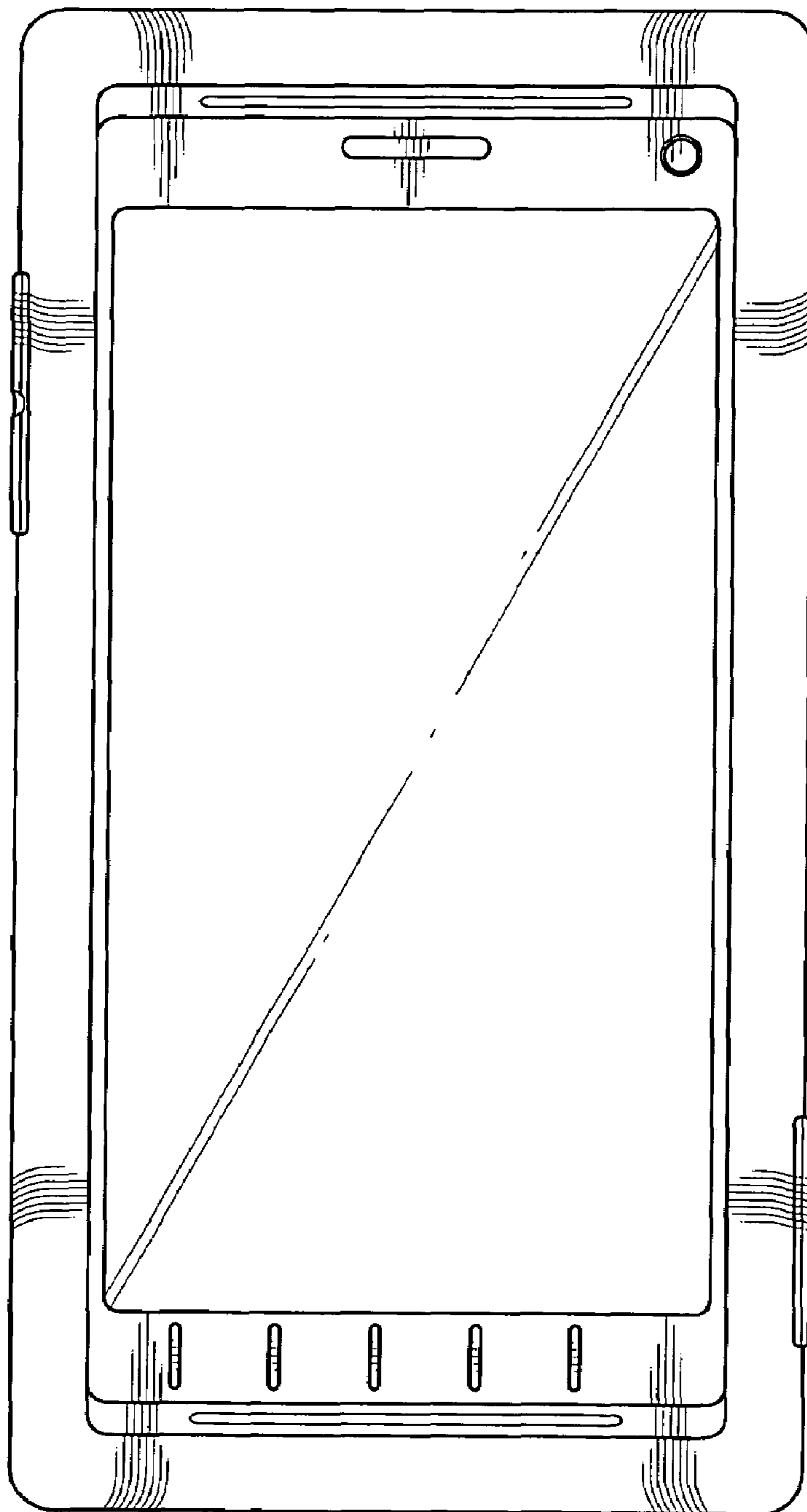

FIG. 3

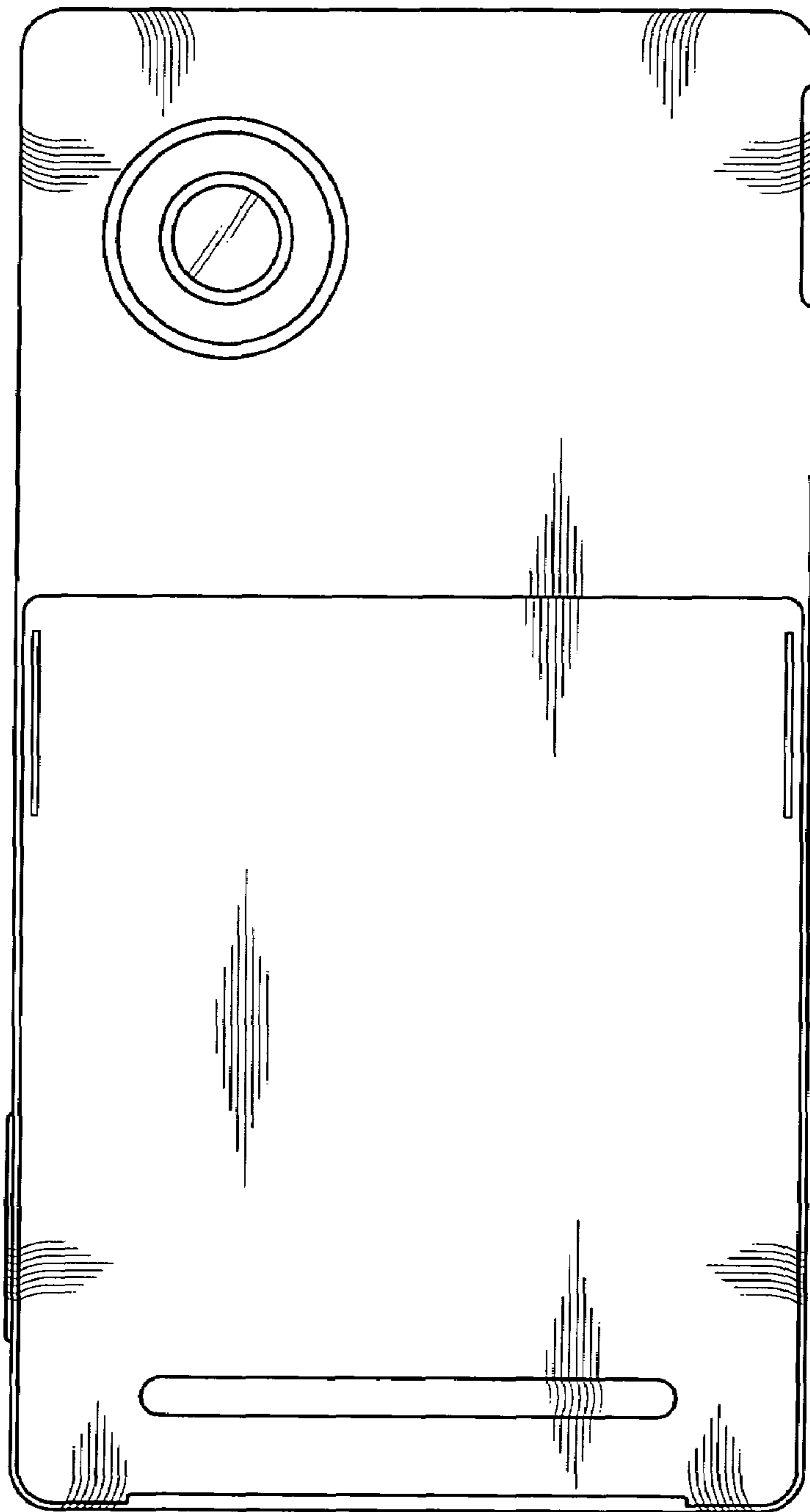

FIG. 4

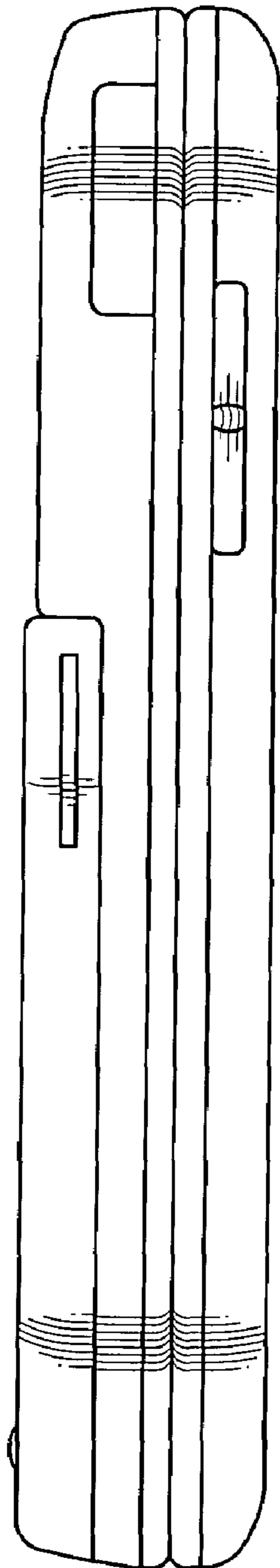

FIG. 5

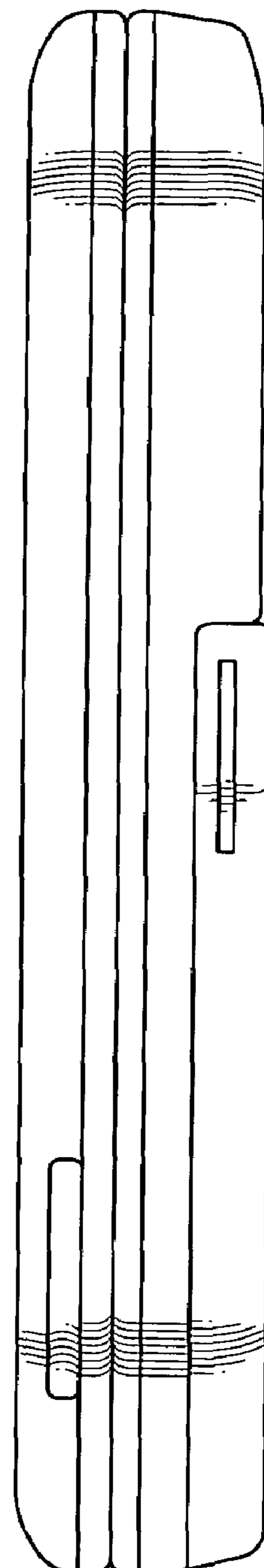

FIG. 6

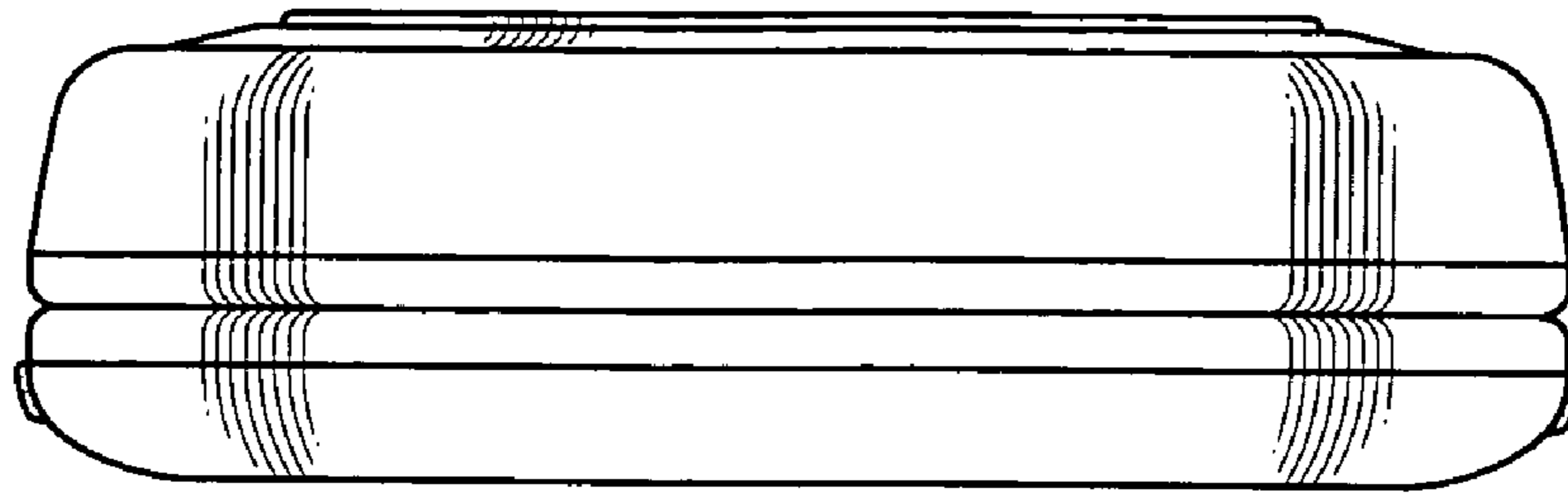

FIG. 7



FIG. 8

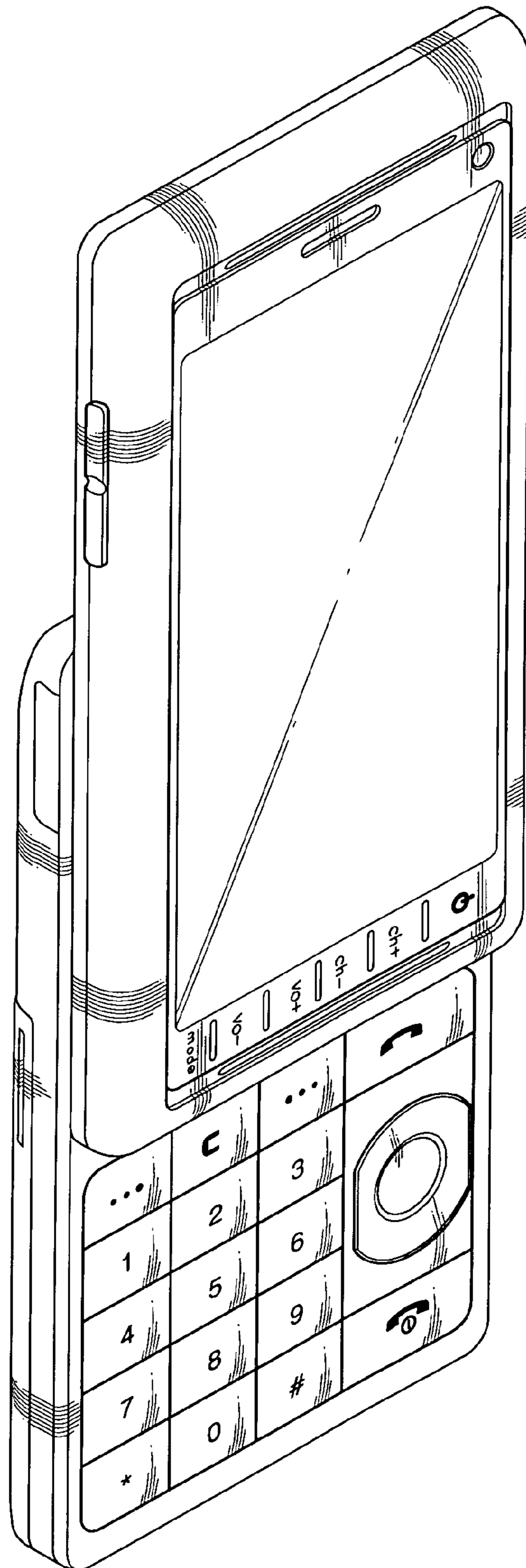



FIG. 9

