



US00D583343S

(12) **United States Design Patent**  
**Lee et al.**

(10) **Patent No.:** **US D583,343 S**

(45) **Date of Patent:** **\*\* Dec. 23, 2008**

(54) **MOBILE PHONE**

(75) Inventors: **Byung-Chan Lee**, Seongnam-si (KR);  
**Joon-Suh Kim**, Anyang-si (KR);  
**Gee-Hong Yoon**, Seongnam-si (KR)

(73) Assignee: **Samsung Electronics Co., Ltd.**,  
Suwon-Si (KR)

(\*\*) Term: **14 Years**

(21) Appl. No.: **29/300,298**

(22) Filed: **Mar. 10, 2008**

(30) **Foreign Application Priority Data**

Nov. 26, 2007 (KR) ..... 30-2007-0048932

(51) **LOC (8) Cl.** ..... **14-03**

(52) **U.S. Cl.** ..... **D14/138 AA**

(58) **Field of Classification Search** ..... D14/137,  
D14/138 R, 138 AA, 138 AD, 138 C, 138 G,  
D14/147-148, 156, 218, 247-248, 341-347,  
D14/390, 455-456, 496; D13/164, 168;  
D16/208; D21/329, 331, 333, 517; 343/702;  
348/14.01-14.02; 361/814; 379/433.01-433.13;  
439/165; 455/90.3, 556.1-556.2, 566, 575.1,  
455/575.3, 575.4

See application file for complete search history.

(56) **References Cited**

**U.S. PATENT DOCUMENTS**

D540,773 S \* 4/2007 Meng et al. .... D14/138 AA  
D555,127 S \* 11/2007 Park et al. .... D14/138 AA  
D559,224 S \* 1/2008 Moon et al. .... D14/138 AA  
D561,154 S \* 2/2008 Kim et al. .... D14/138 AA  
D561,729 S \* 2/2008 Kim et al. .... D14/138 AA  
D572,698 S \* 7/2008 Kim et al. .... D14/138  
D572,700 S \* 7/2008 Kwon et al. .... D14/138  
D573,130 S \* 7/2008 Kim et al. .... D14/138

D573,567 S \* 7/2008 Chang et al. .... D14/138  
D573,570 S \* 7/2008 Park et al. .... D14/138  
D574,800 S \* 8/2008 Stillerman .... D14/138  
D574,805 S \* 8/2008 Cobb .... D14/138  
2008/0039156 A1 \* 2/2008 Lee et al. .... 455/575.1

**OTHER PUBLICATIONS**

Toshiba TS608, announced Jun. 2006, <URL:http://www.gsmarena.com/toshiba\_ts608-pictures-1698.php>, retrieved from internet Sep. 11, 2008 3:05:19 PM.\*

Sony Ericsson W890, announced Nov. 2007, <URL:http://www.gsmarena.com/sony\_ericsson\_w890-pictures-2172.php>, retrieved from internet Sep. 11, 2008 3:08:40 PM.\*

\* cited by examiner

*Primary Examiner*—Ian Simmons

*Assistant Examiner*—Carla Jobe Wright

(74) *Attorney, Agent, or Firm*—Staas & Halsey LLP

(57) **CLAIM**

The ornamental design for a mobile phone, as shown and described.

**DESCRIPTION**

FIG. 1 is a perspective view of a mobile phone;  
FIG. 2 is a front view of the mobile phone of FIG. 1;  
FIG. 3 is a rear view of the mobile phone of FIG. 1;  
FIG. 4 is a left-side view of the mobile phone of FIG. 1;  
FIG. 5 is a right-side view of the mobile phone of FIG. 1;  
FIG. 6 is a top plan view of the mobile phone of FIG. 1;  
FIG. 7 is a bottom plan view of the mobile phone of FIG. 1;  
and,  
FIG. 8 is a perspective view of the mobile phone of FIG. 1 in an open condition displaying the keypad in an operational state.

**1 Claim, 5 Drawing Sheets**

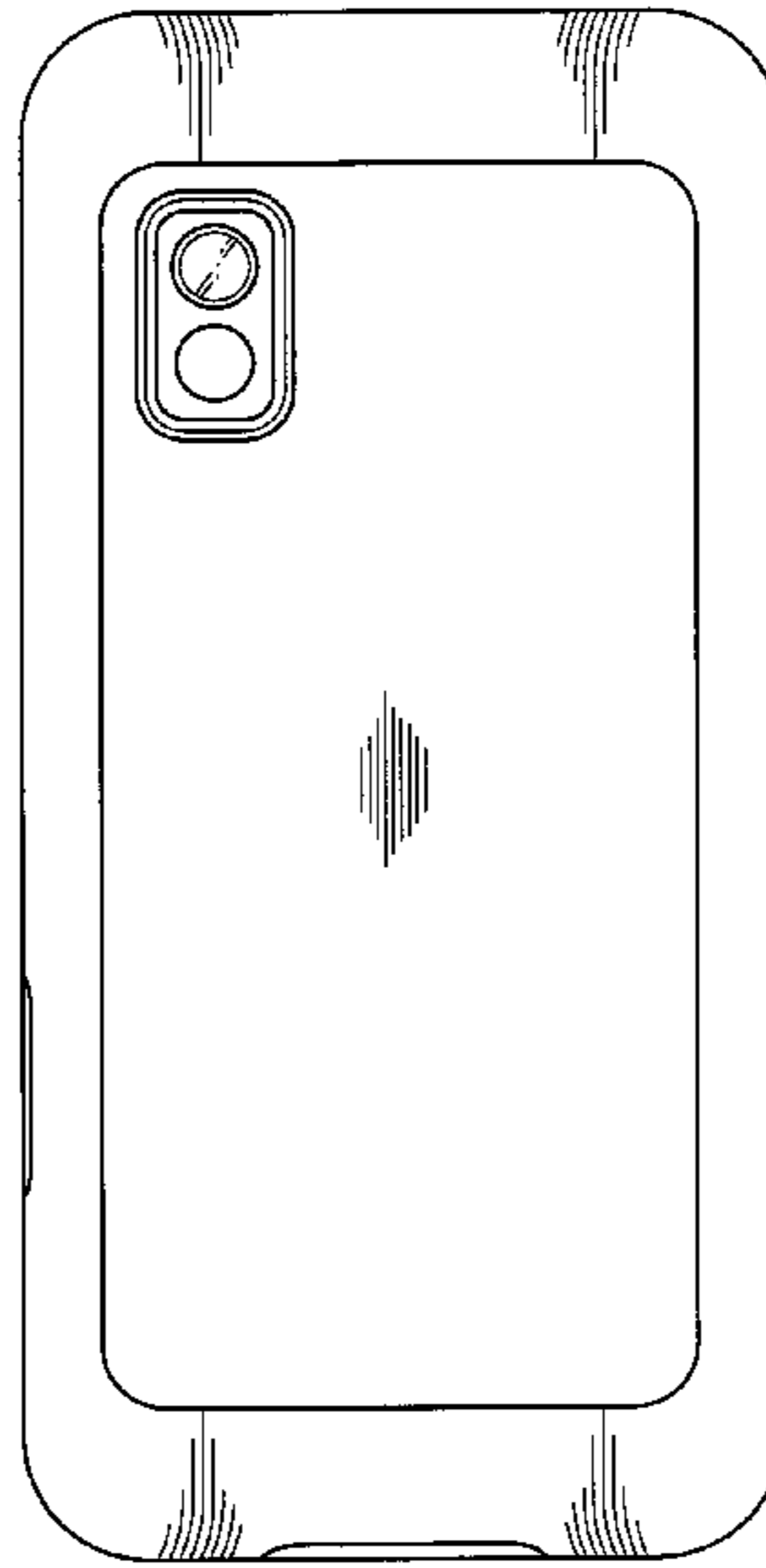
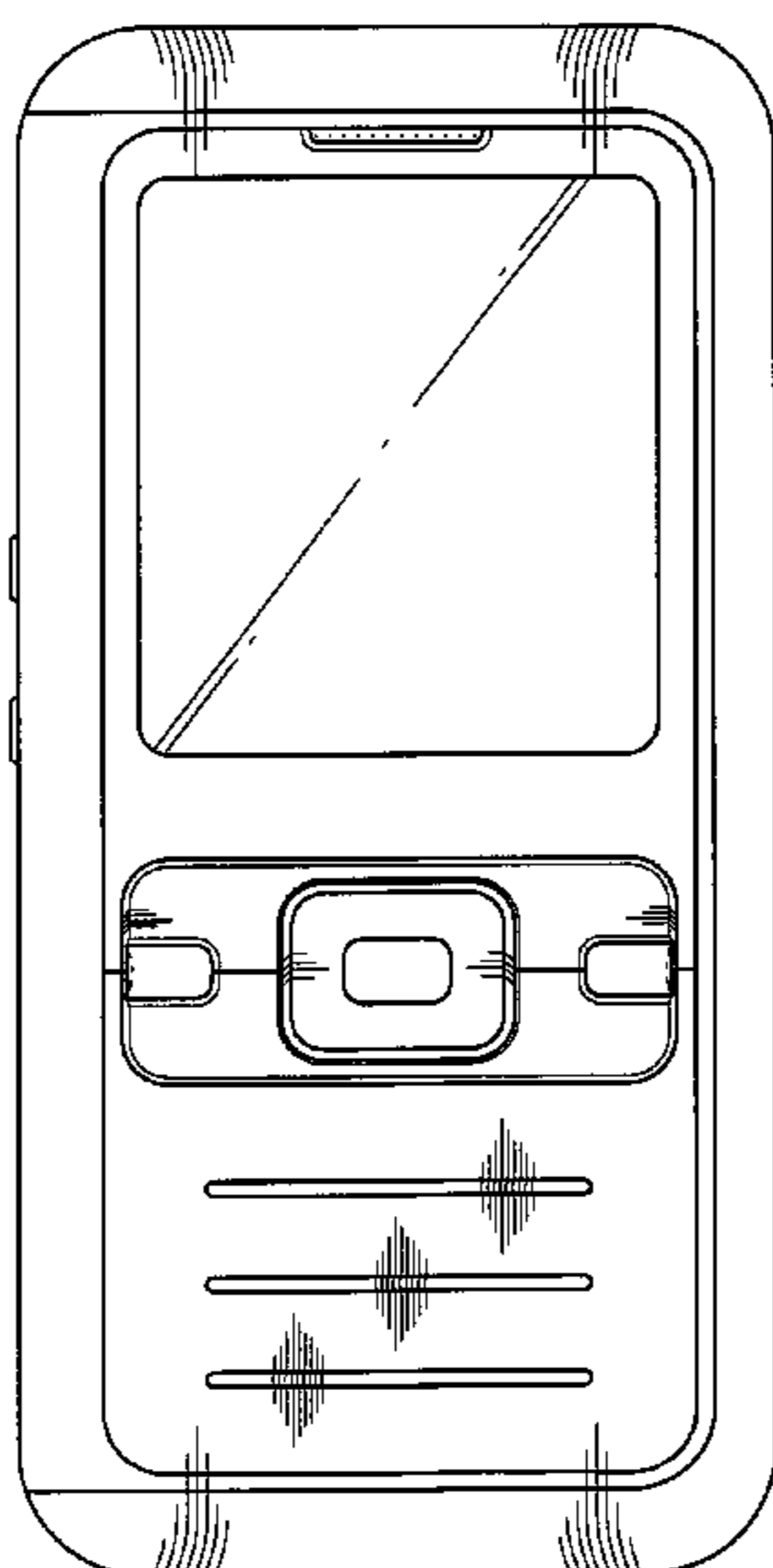

FIG. 1

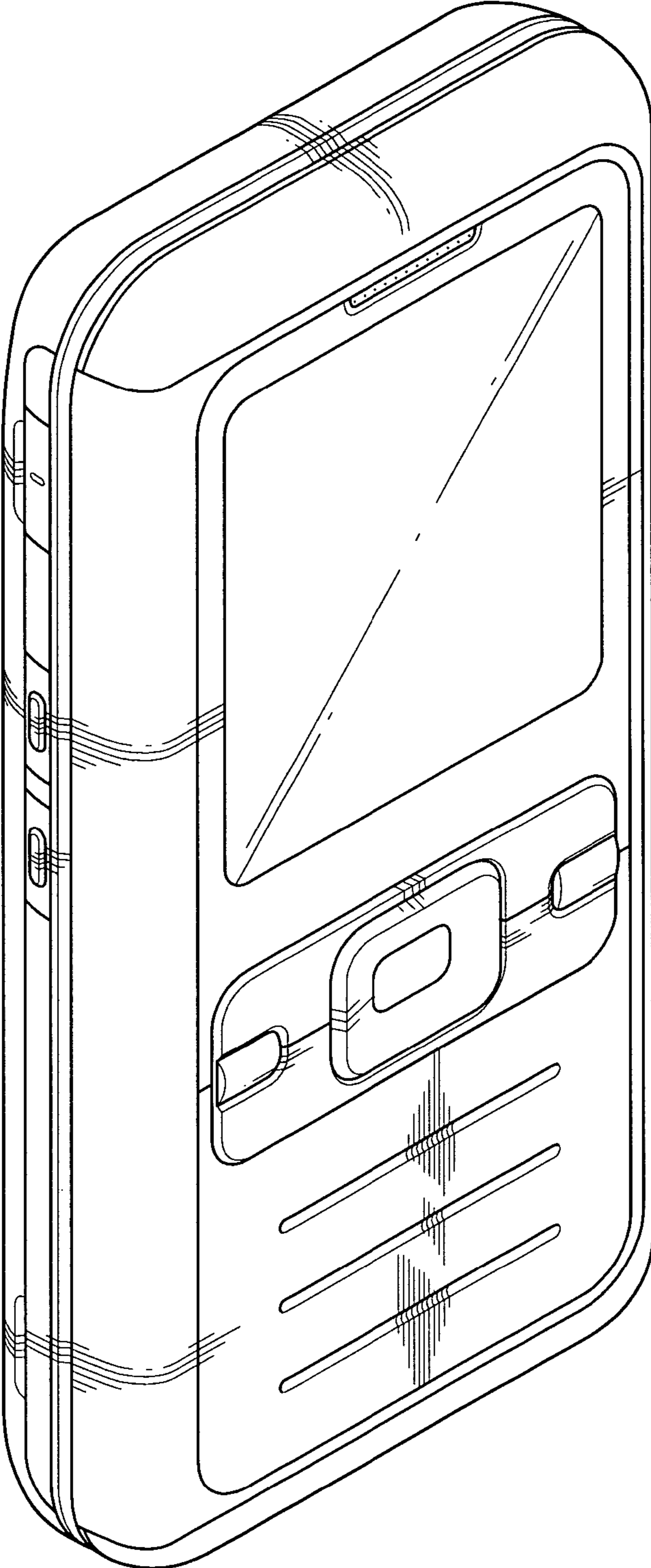

FIG. 2

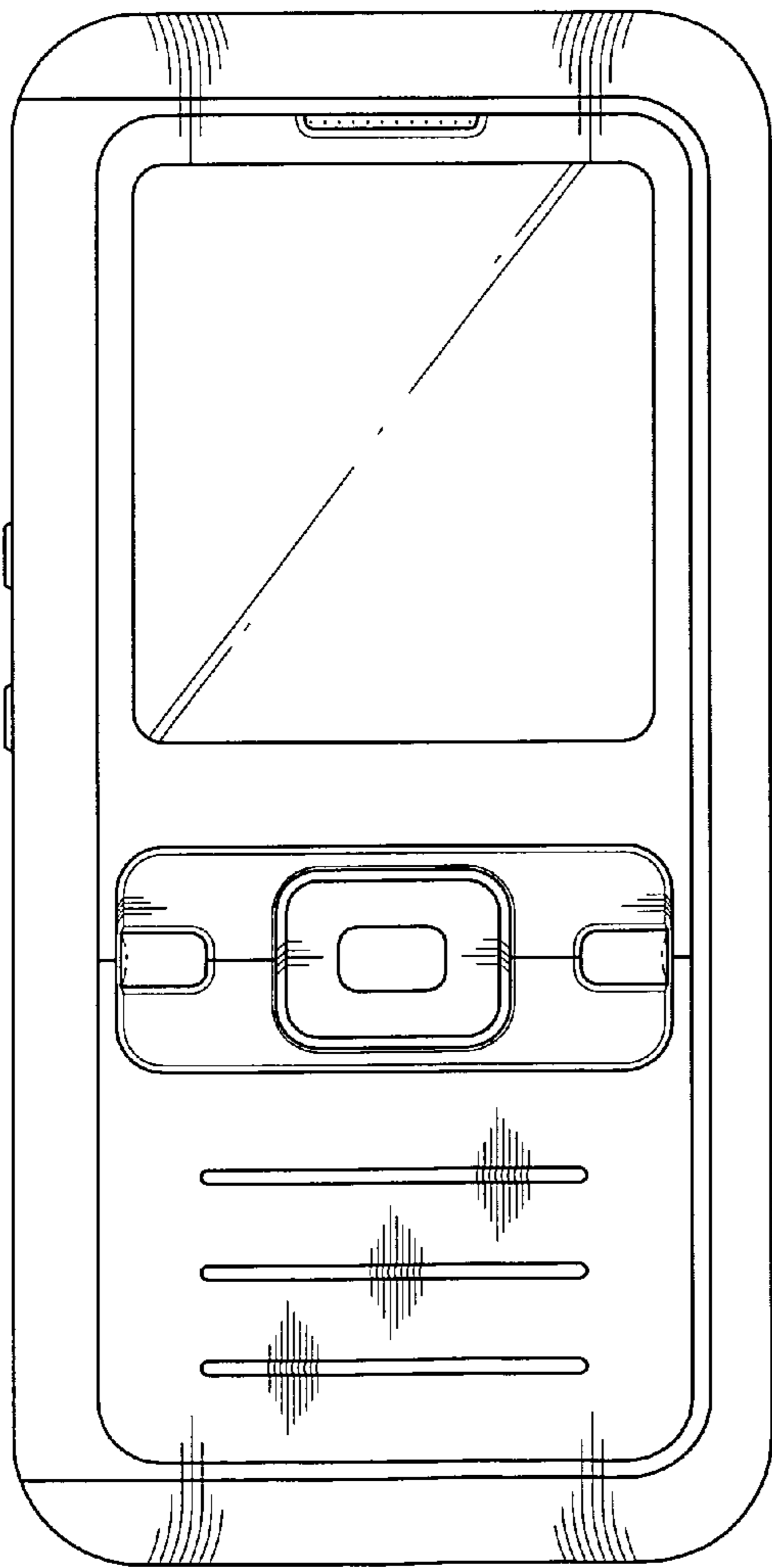

FIG. 3

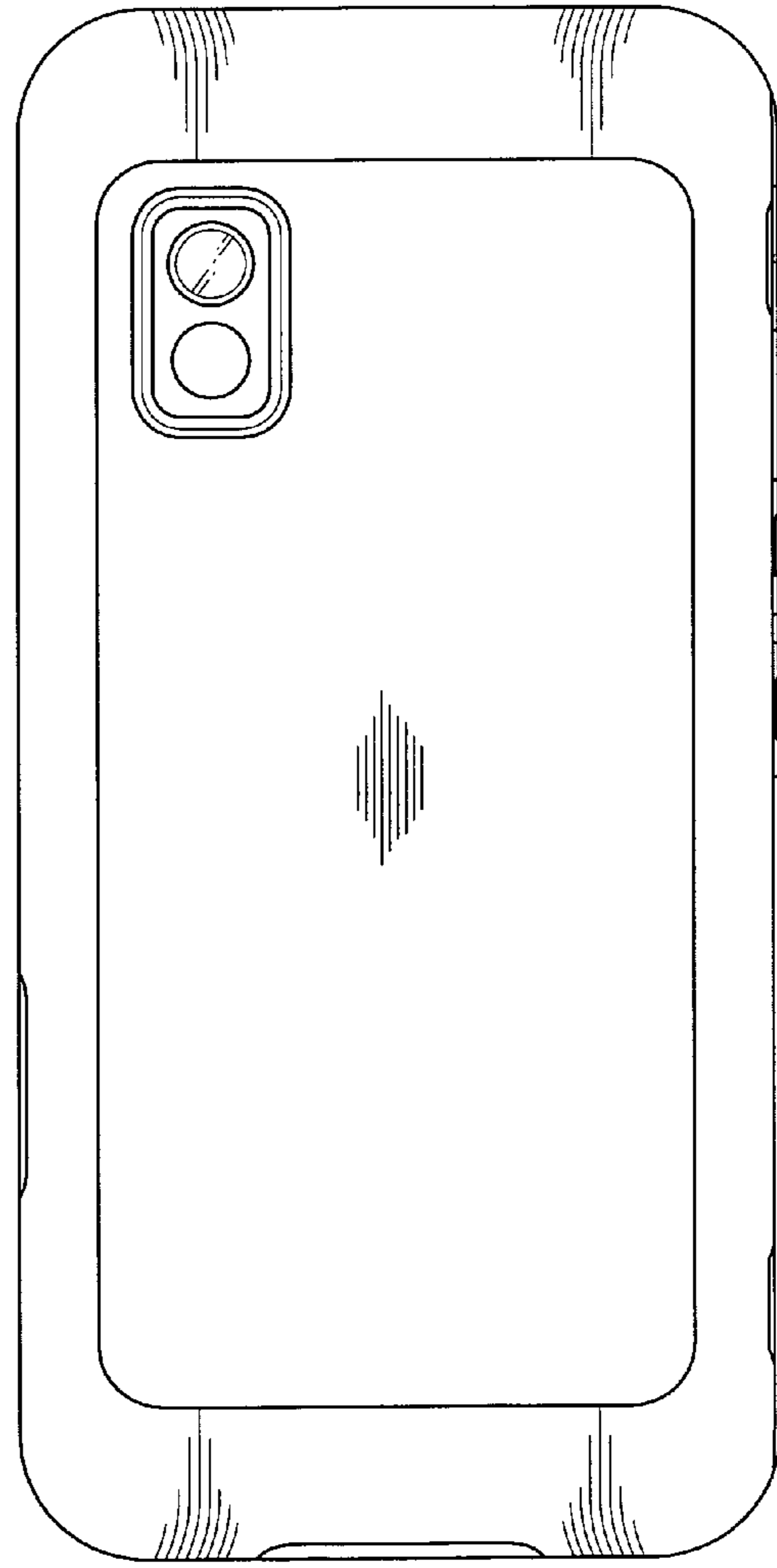

FIG. 4

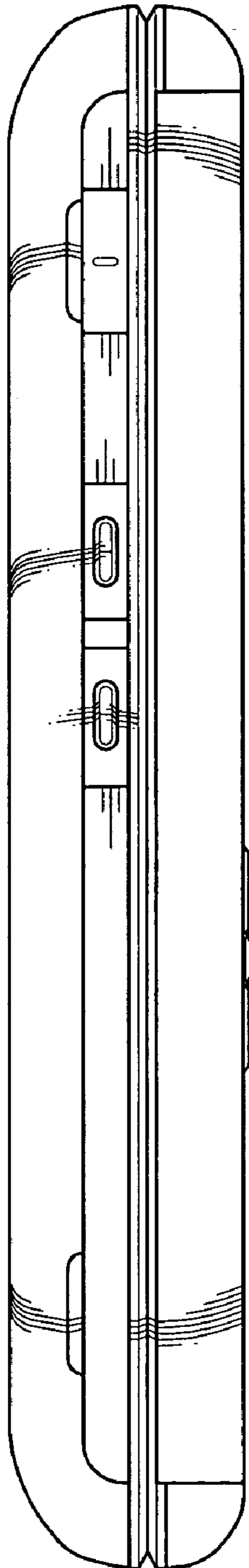

FIG. 5

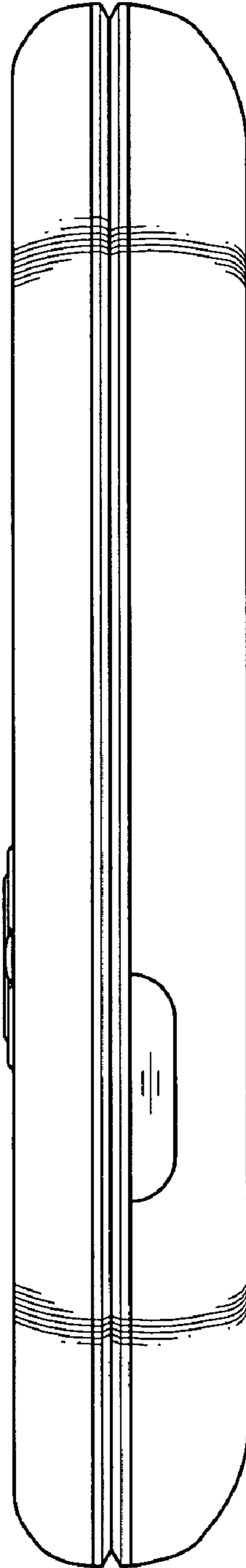

FIG. 6

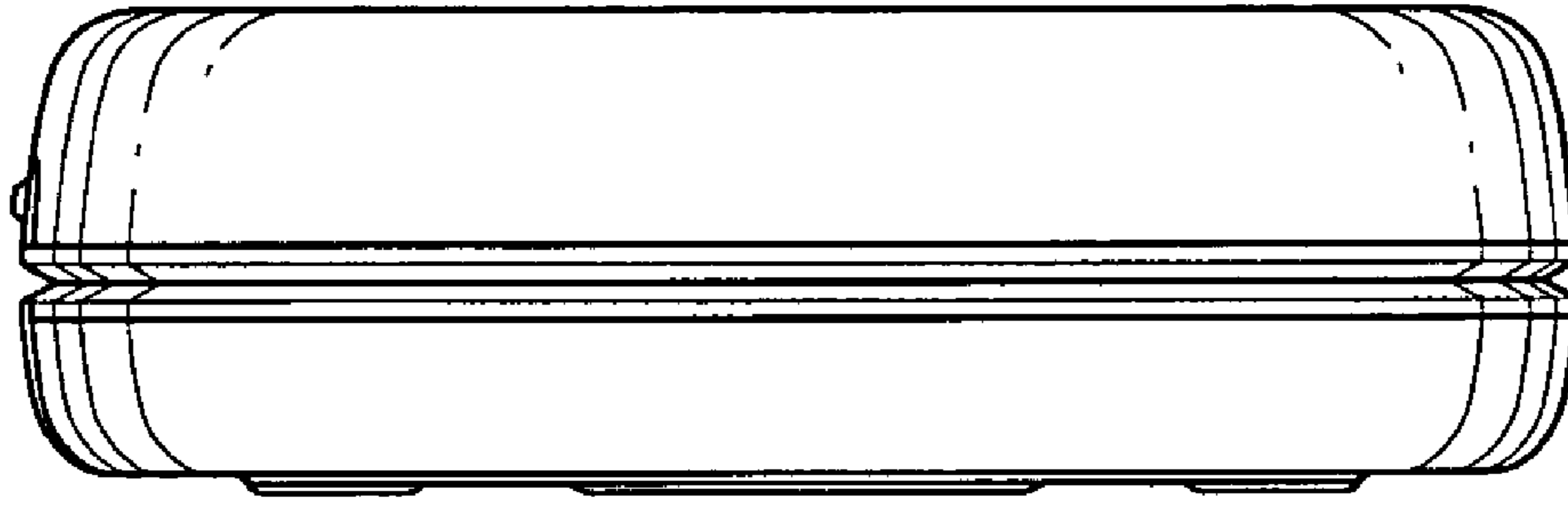

FIG. 7

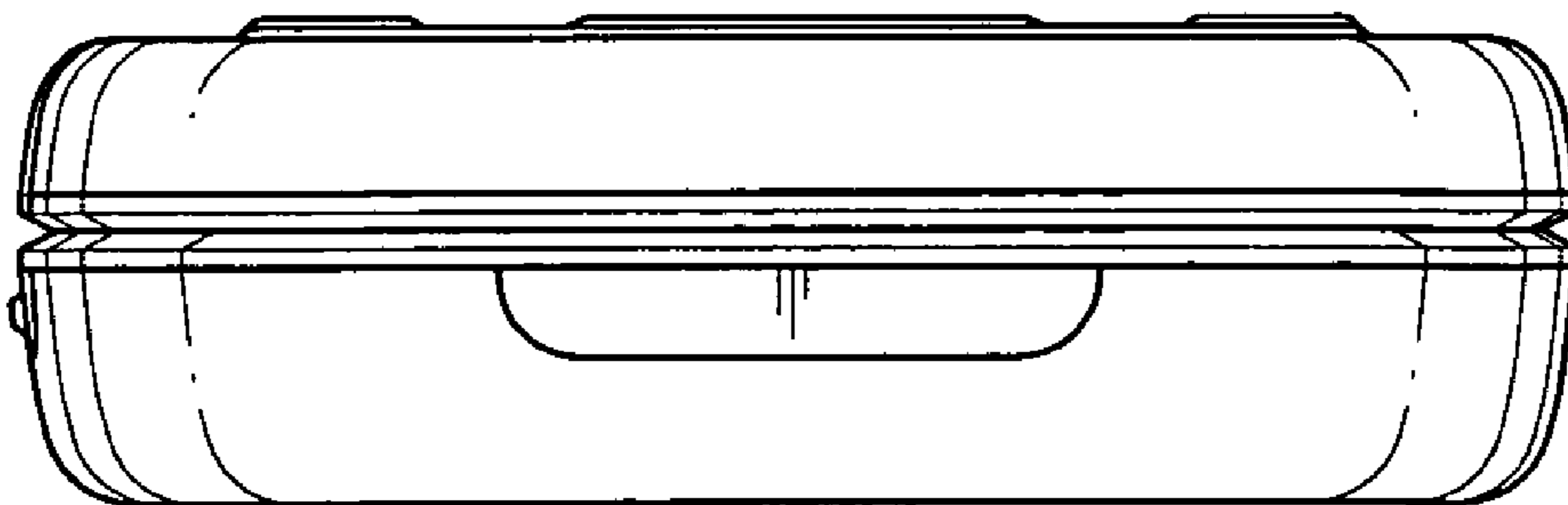

FIG. 8

