



US00D583287S

(12) **United States Design Patent**
Shimokawa

(10) **Patent No.:** **US D583,287 S**
(45) **Date of Patent:** **** Dec. 23, 2008**

(54) **MUFFLER FOR AN INTERNAL COMBUSTION ENGINE**

(75) Inventor: **Kouichi Shimokawa**, Kawagoe (JP)

(73) Assignee: **Husqvarna Zenoah Co., Ltd.**,
Kawagoe-shi (JP)

(**) Term: **14 Years**

(21) Appl. No.: **29/299,453**

(22) Filed: **Dec. 27, 2007**

(30) **Foreign Application Priority Data**

Jun. 29, 2007 (JP) 2007-017458

(51) **LOC (8) Cl.** **12-16**

(52) **U.S. Cl.** **D12/194**

(58) **Field of Classification Search** D12/86,
D12/90, 91, 92, 167, 169, 170, 196, 194,
D12/206, 209; 280/152.1, 152.2, 152.3,
280/160.1, 304.3, 770, 848, 852; 29/890.08;
293/105, 113, 115; 296/180.1, 180.2, 77.1,
296/78.1, 85; 60/313, 323; D23/393; D15/5;
454/69, 71, 81; 181/227, 228, 247, 248,
181/249, 250, 251, 264, 282; 180/225, 229,
180/296, 309, 89.2, 219

See application file for complete search history.

(56) **References Cited**

U.S. PATENT DOCUMENTS

D197,175 S * 12/1963 Gordon D12/194

4,909,348 A * 3/1990 Harwood et al. 181/282
5,004,069 A * 4/1991 Van Blaircum et al. 181/282
D363,908 S * 11/1995 Maag D12/194
6,017,197 A * 1/2000 Jensen et al. 181/249
D446,489 S * 8/2001 Park D12/194
D452,672 S * 1/2002 Kim D12/194
D537,396 S * 2/2007 Drew et al. D12/194

* cited by examiner

Primary Examiner—Louis S Zarfaz

Assistant Examiner—Michael A Pratt

(74) *Attorney, Agent, or Firm*—Synnestvedt & Lechner, LLP

(57) **CLAIM**

The ornamental design for a muffler for an internal combustion engine, as shown.

DESCRIPTION

FIG. 1 is a front perspective view of a muffler for an internal combustion engine showing my new design;

FIG. 2 is a rear perspective view thereof;

FIG. 3 is a front view thereof;

FIG. 4 is a rear view thereof;

FIG. 5 is a top plan view thereof;

FIG. 6 is a bottom plan view thereof;

FIG. 7 is a right side view thereof; and,

FIG. 8 is a left side view thereof.

1 Claim, 7 Drawing Sheets

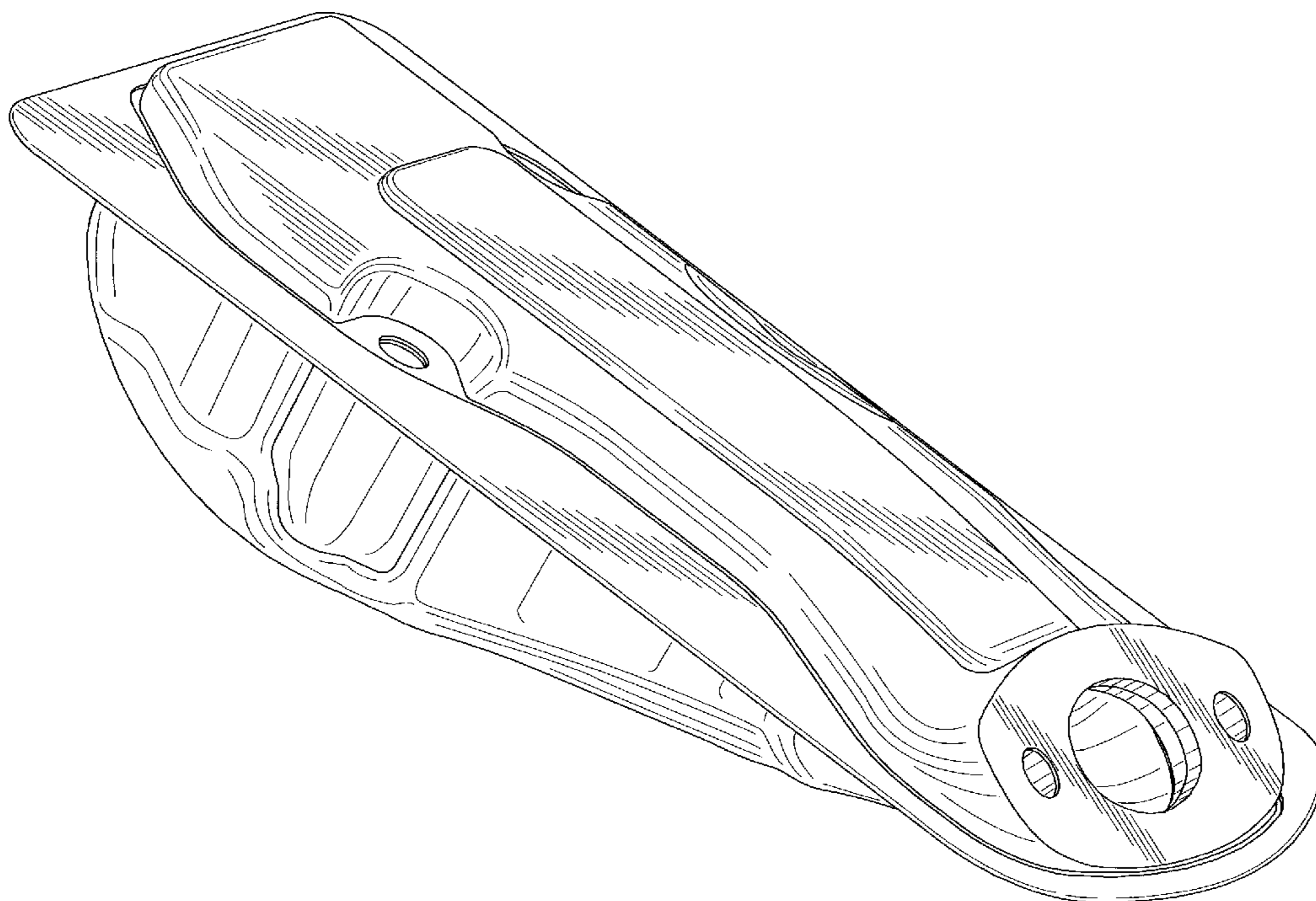
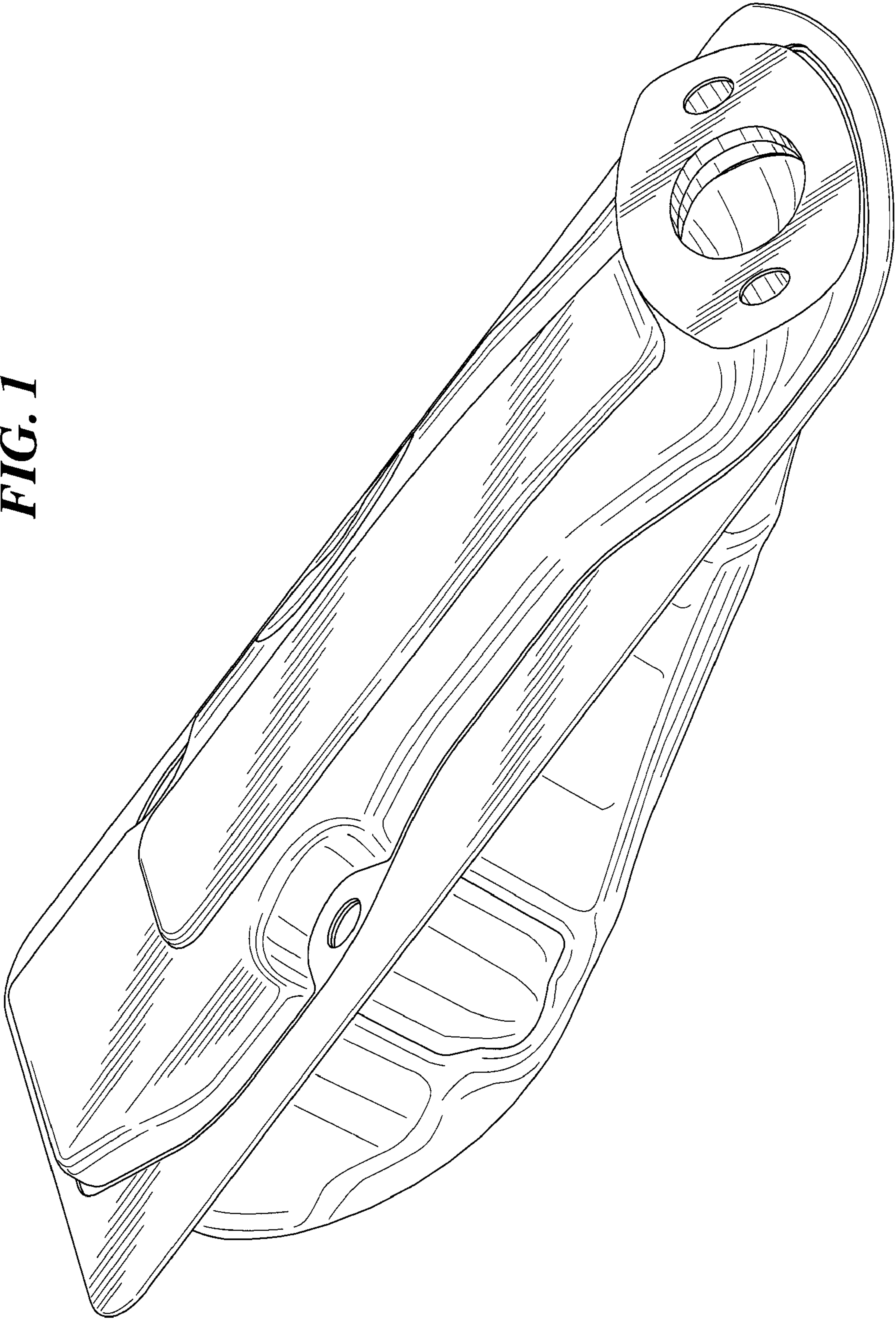

FIG. 1



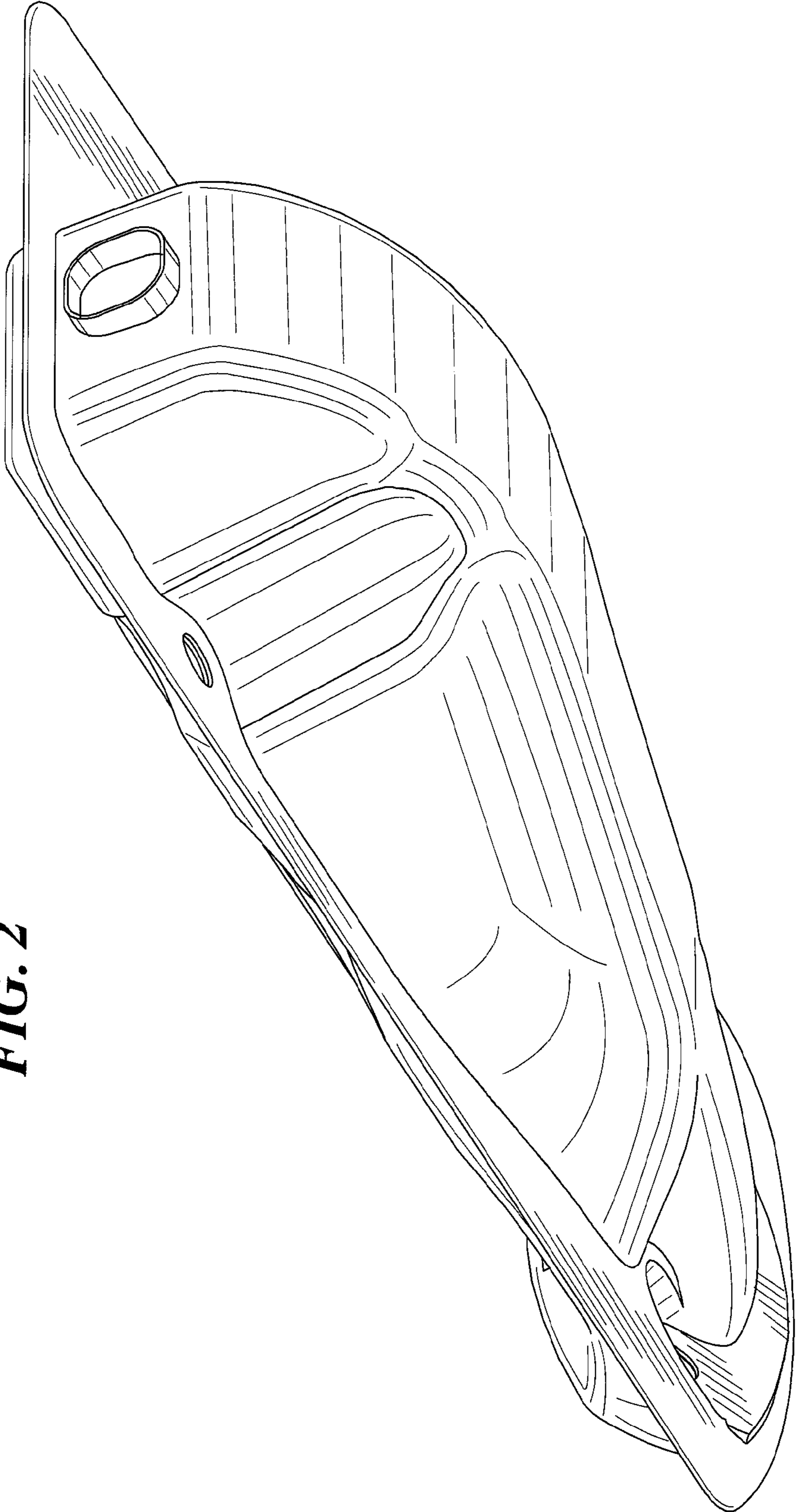

FIG. 2

FIG. 3

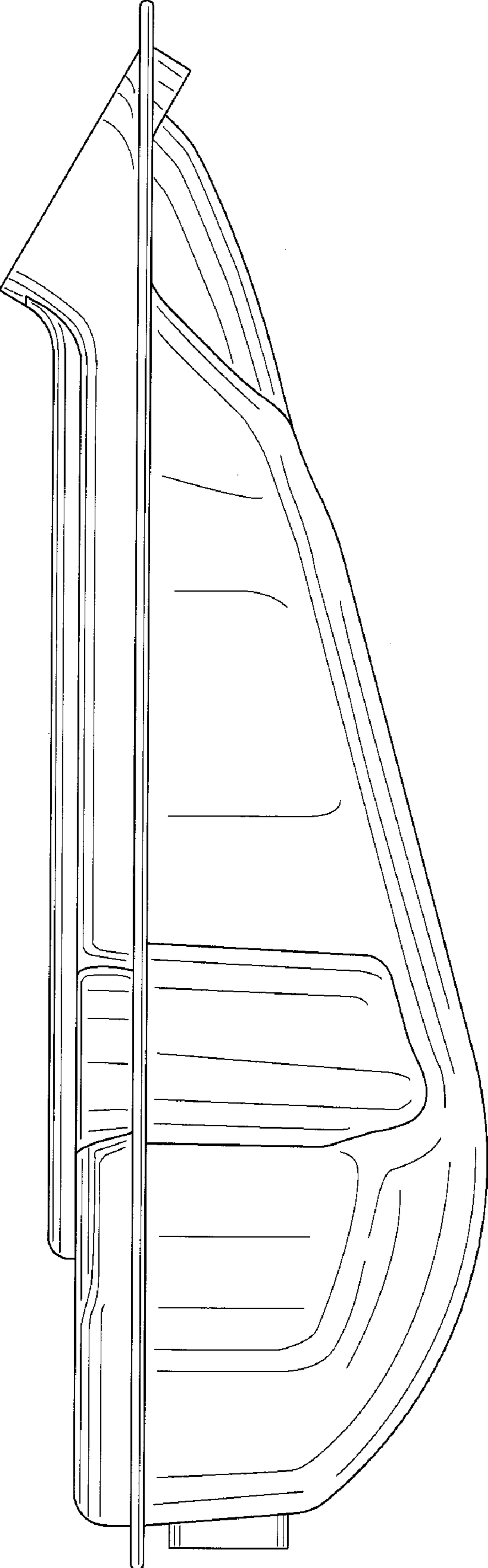

FIG. 4

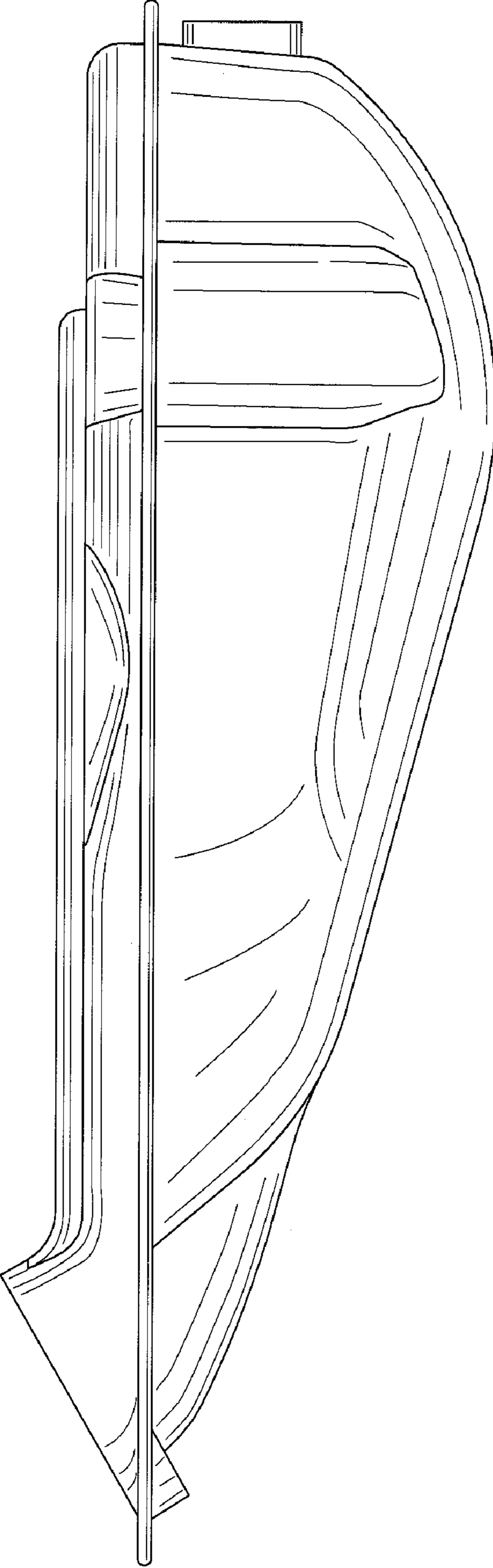

FIG. 5

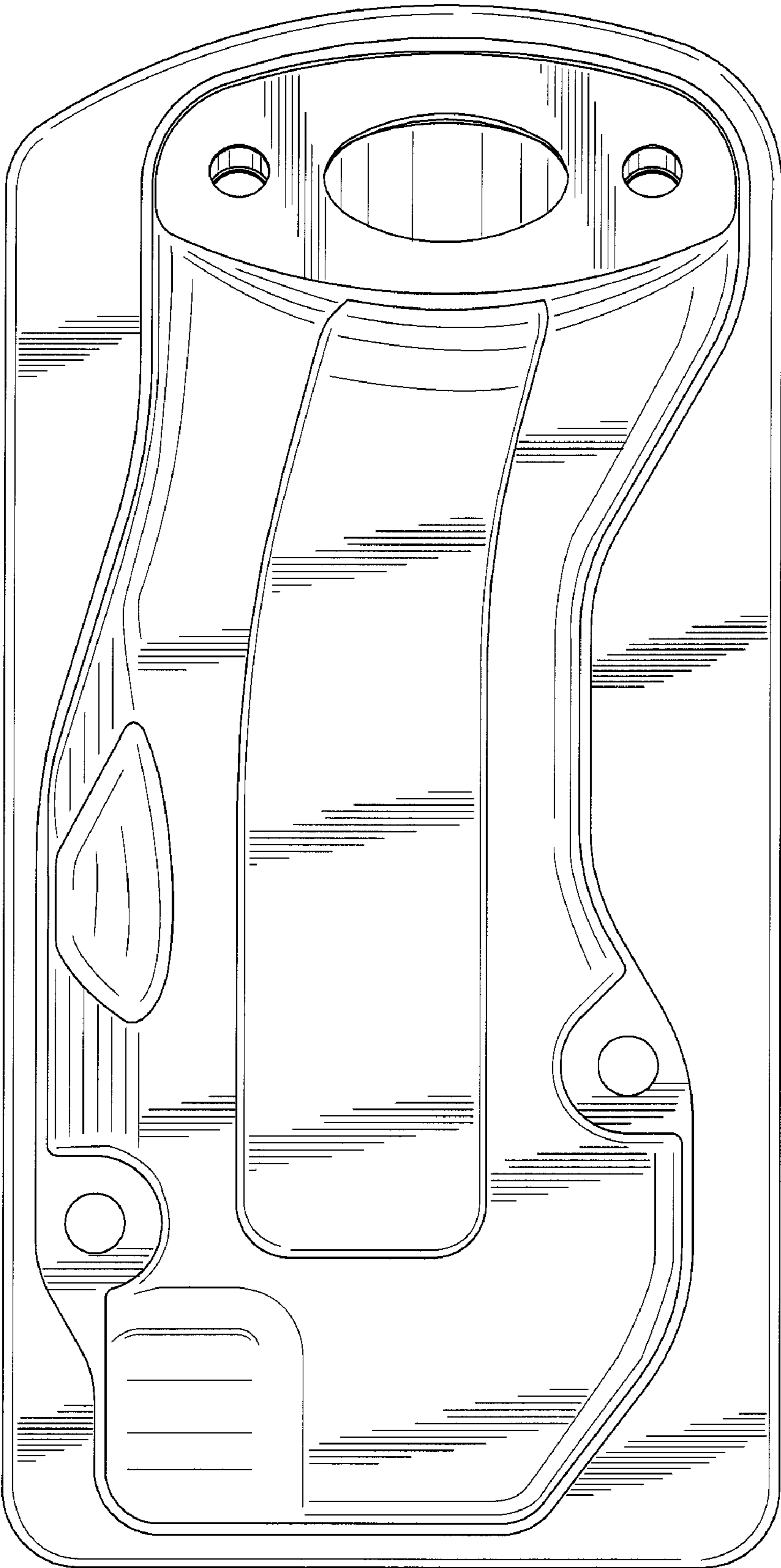

FIG. 6

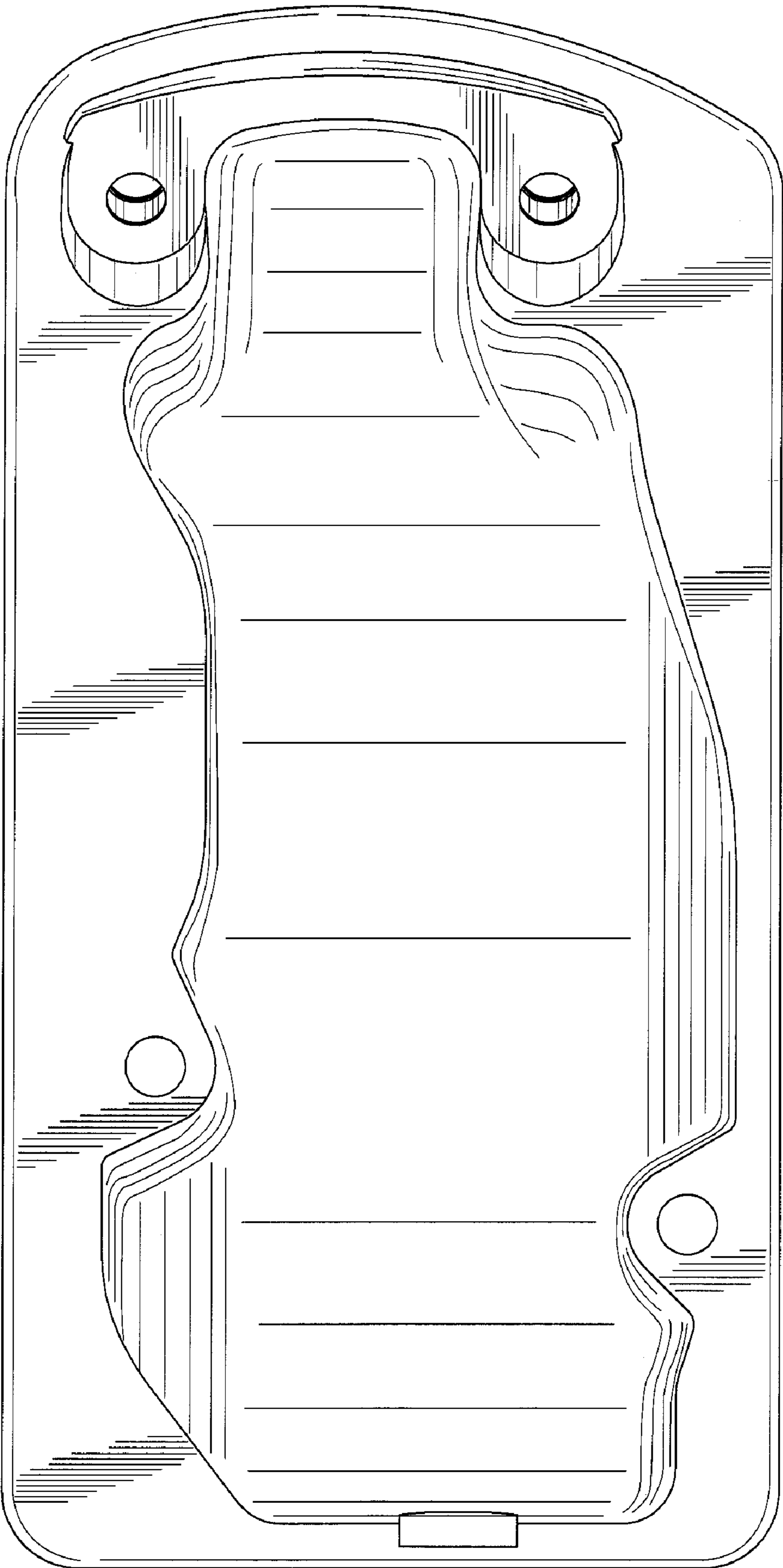

FIG. 7

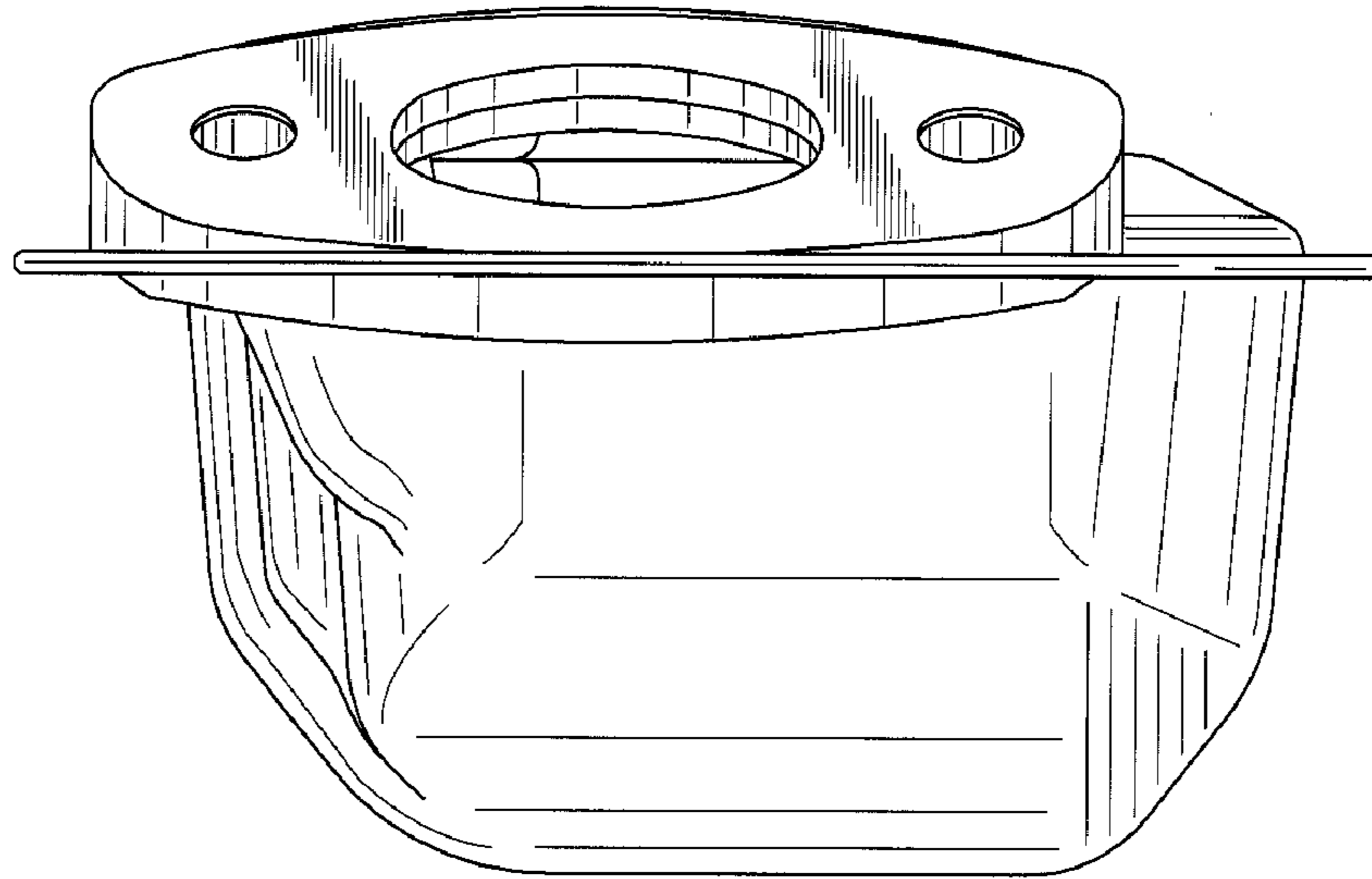

FIG. 8

