



US00D583246S

(12) **United States Design Patent**
Kaminski

(10) **Patent No.:** **US D583,246 S**
(45) **Date of Patent:** **** Dec. 23, 2008**

(54) **PLASTIC CONTAINER**

(75) Inventor: **Christopher E. Kaminski**, North
Royalton, OH (US)

(73) Assignee: **Plastipak Packaging, Inc.**, Plymouth,
MI (US)

(**) Term: **14 Years**

(21) Appl. No.: **29/270,780**

(22) Filed: **Jan. 3, 2007**

(51) **LOC (8) Cl.** **09-01**

(52) **U.S. Cl.** **D9/543; D9/560**

(58) **Field of Classification Search** D9/516,
D9/520, 522, 530, 541-543, 546, 550, 554,
D9/573-575; 215/12.1-12.2, 13.1, 381-385,
215/396, 398

See application file for complete search history.

(56) **References Cited**

U.S. PATENT DOCUMENTS

- D198,407 S * 6/1964 Busch D9/543
- D448,675 S * 10/2001 Thierjung D9/541
- D510,034 S * 9/2005 Hong et al. D9/645
- D527,645 S * 9/2006 Pedmo et al. D9/542
- 2007/0045222 A1 * 3/2007 Denner et al. 215/382

* cited by examiner

Primary Examiner—Nanda Bondade
(74) *Attorney, Agent, or Firm*—Dykema Gossett PLLC

(57) **CLAIM**

The ornamental design for a plastic container, as shown and described.

DESCRIPTION

FIG. 1 is a perspective view of the plastic container showing my new design and showing the top, front and right side thereof;

FIG. 2 is a perspective view showing the top, rear and left side thereof;

FIG. 3 is a front elevation view thereof;

FIG. 4 is a rear elevation view thereof;

FIG. 5 is a top plan view thereof;

FIG. 6 is a bottom plan view thereof;

FIG. 7 is a left side elevation view thereof; and,

FIG. 8 is a right side elevation view thereof.

The broken lines shown in the drawings are for illustrative purposes only and form no part of the claimed design.

1 Claim, 3 Drawing Sheets

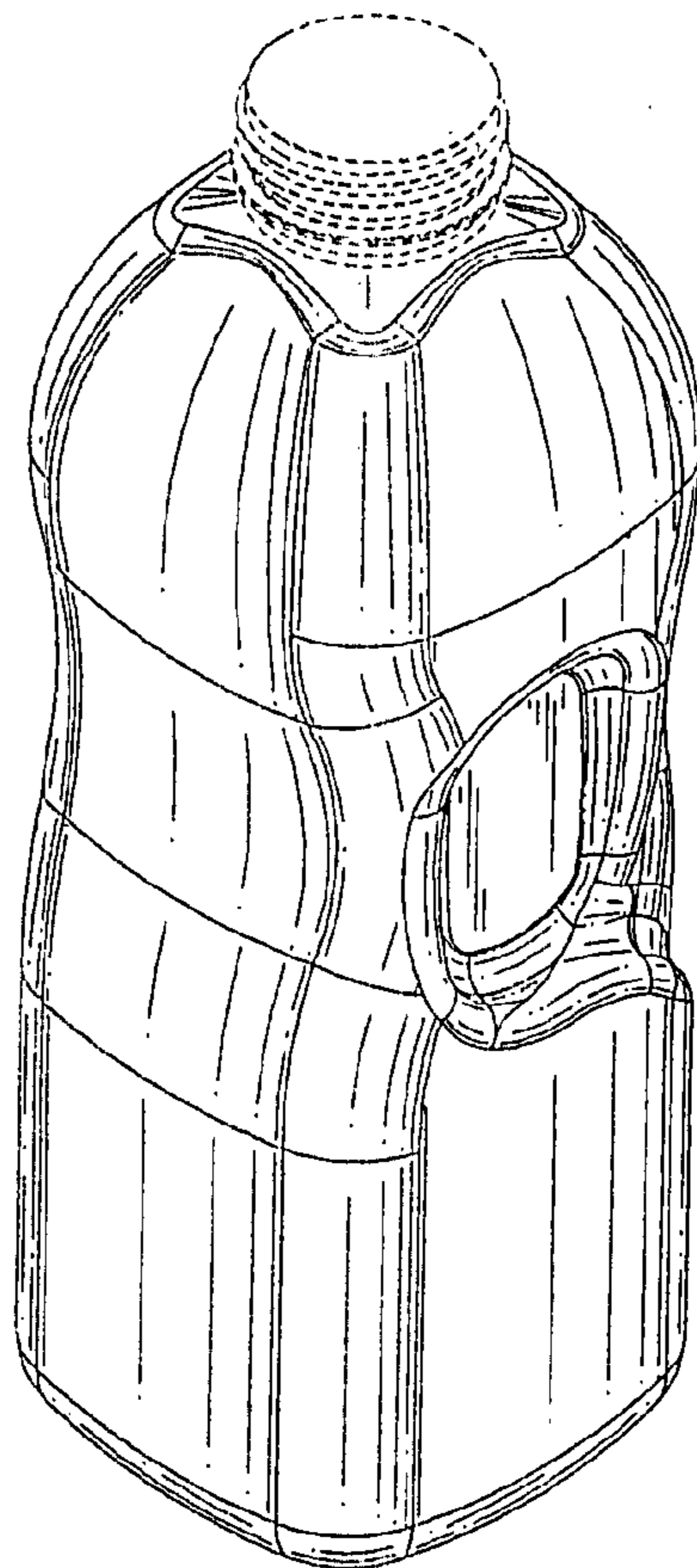

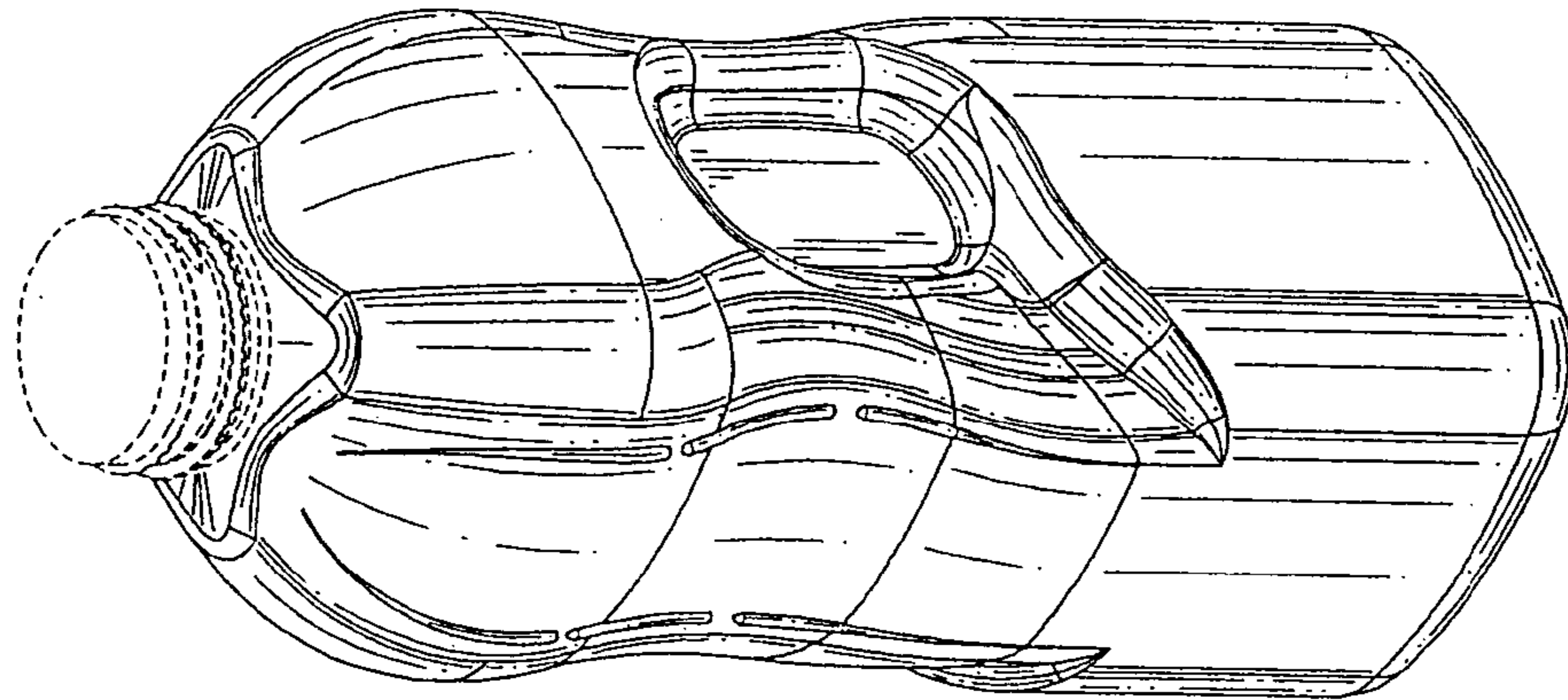

FIG. 1

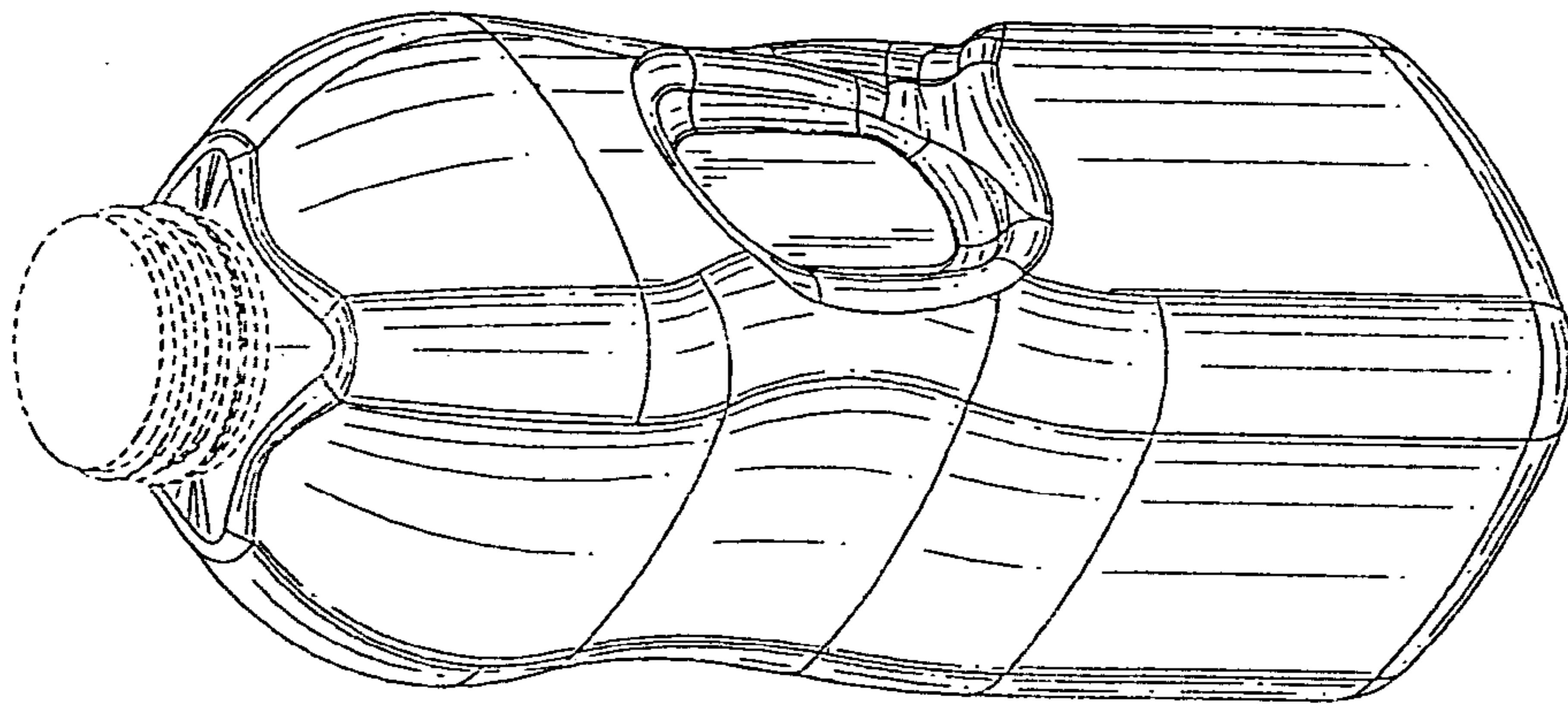

FIG. 2

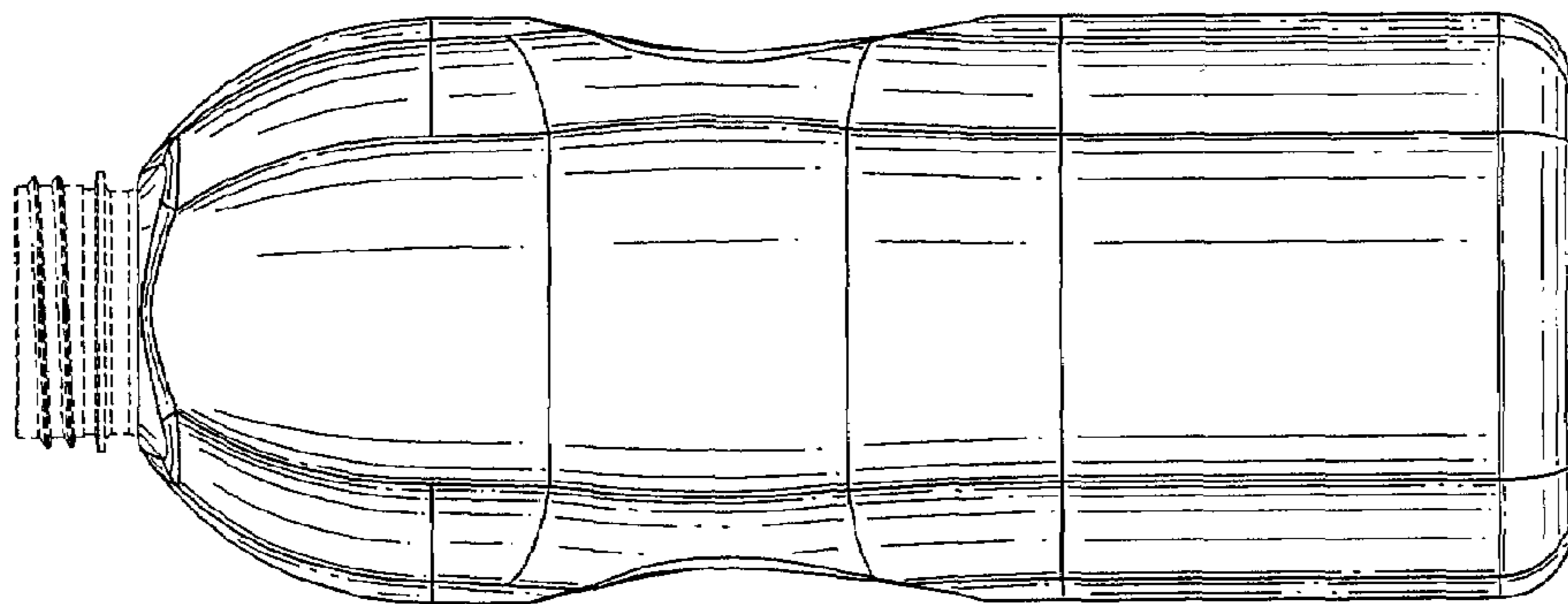

FIG. 3

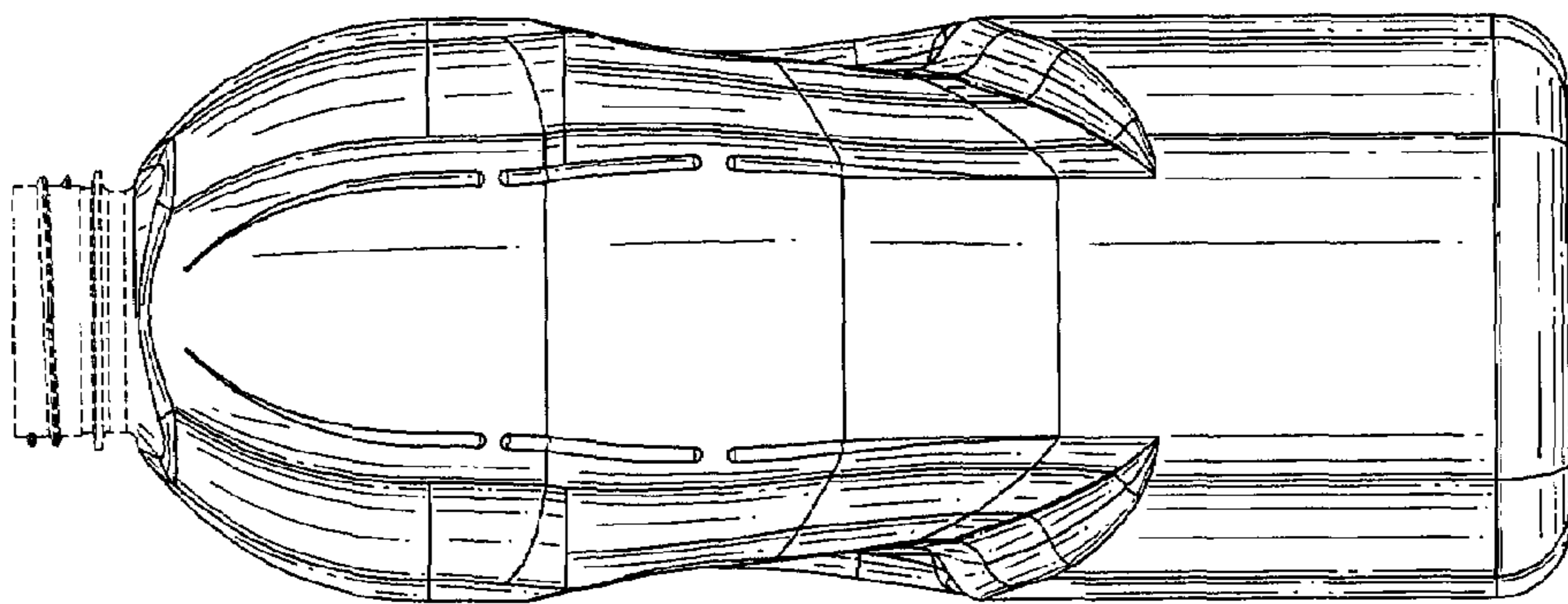

FIG. 4

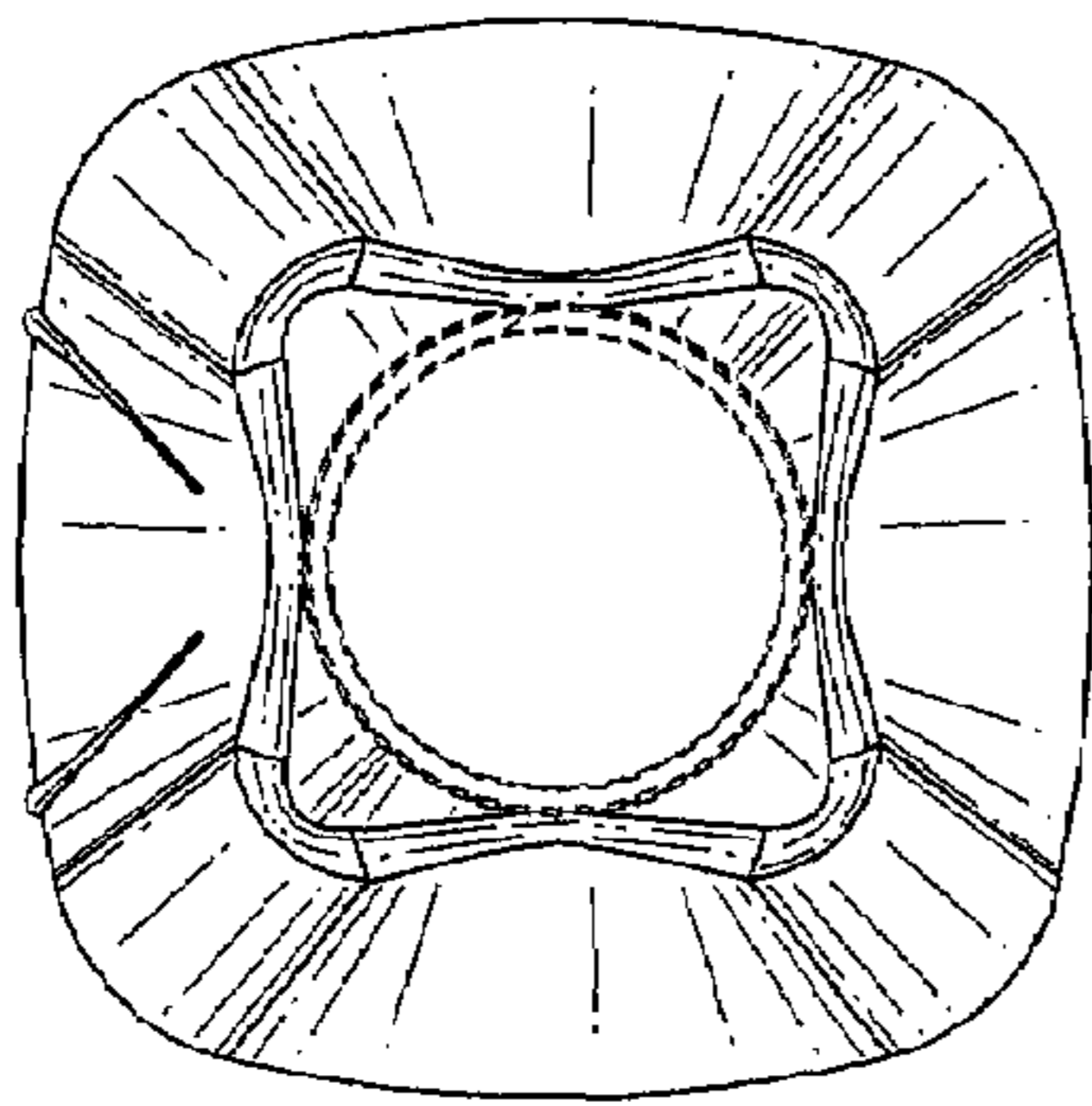

FIG. 5

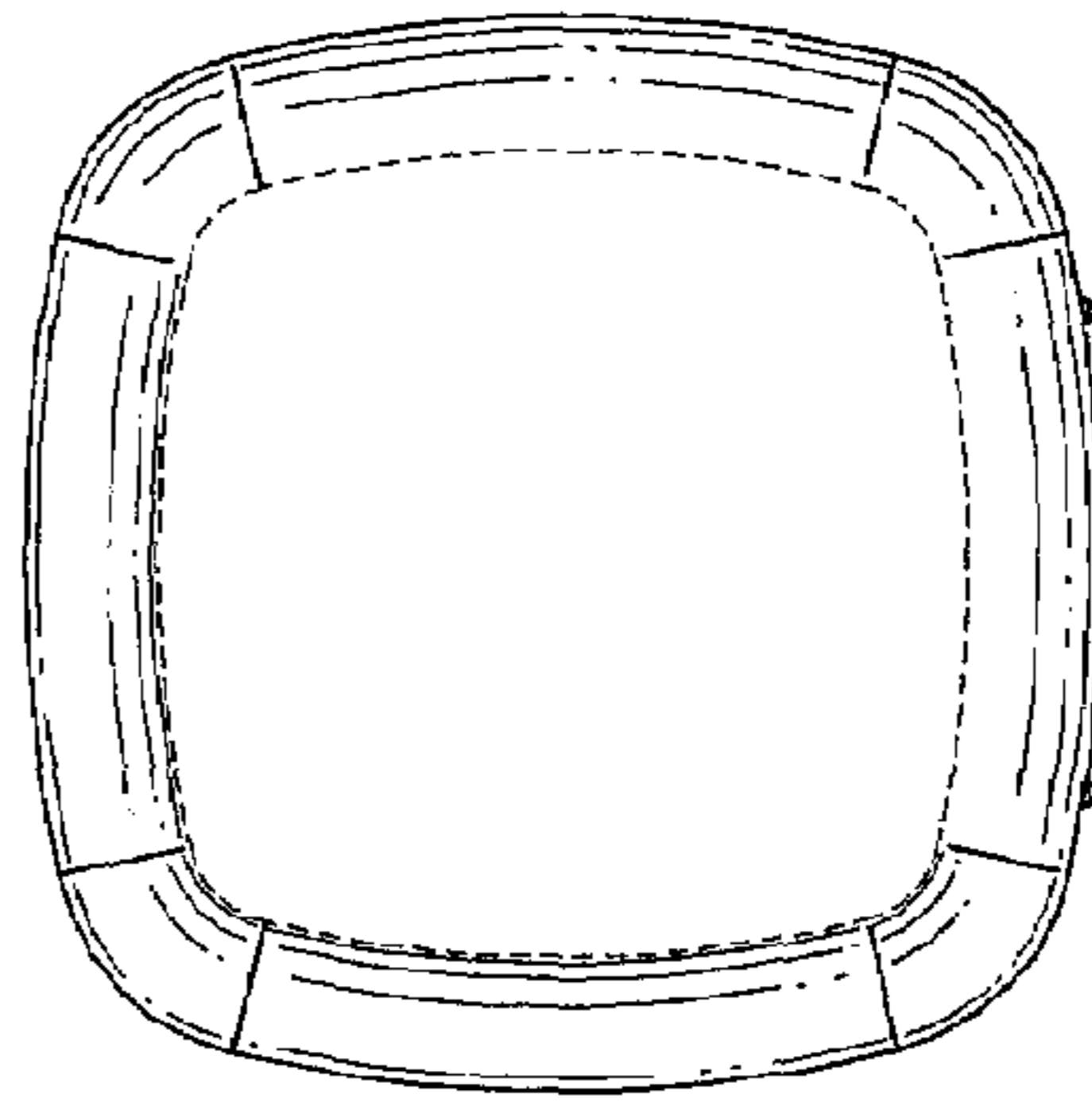

FIG. 6

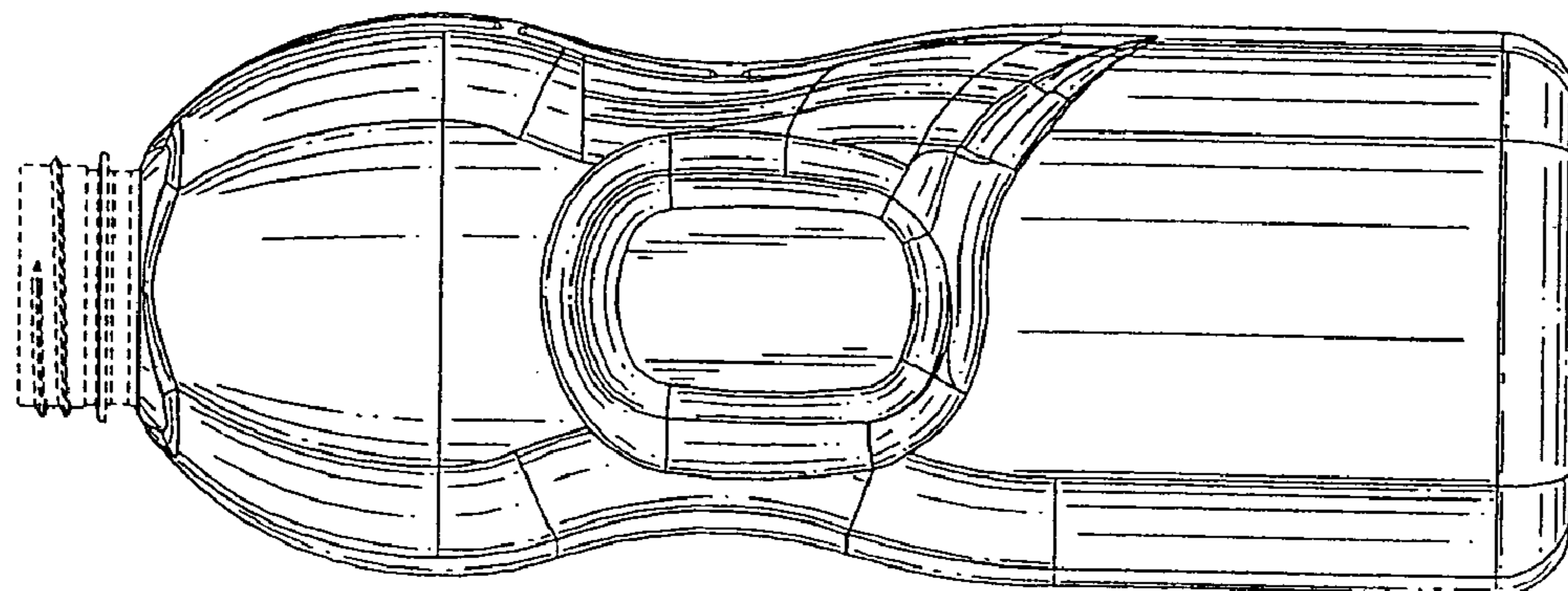

FIG. 7

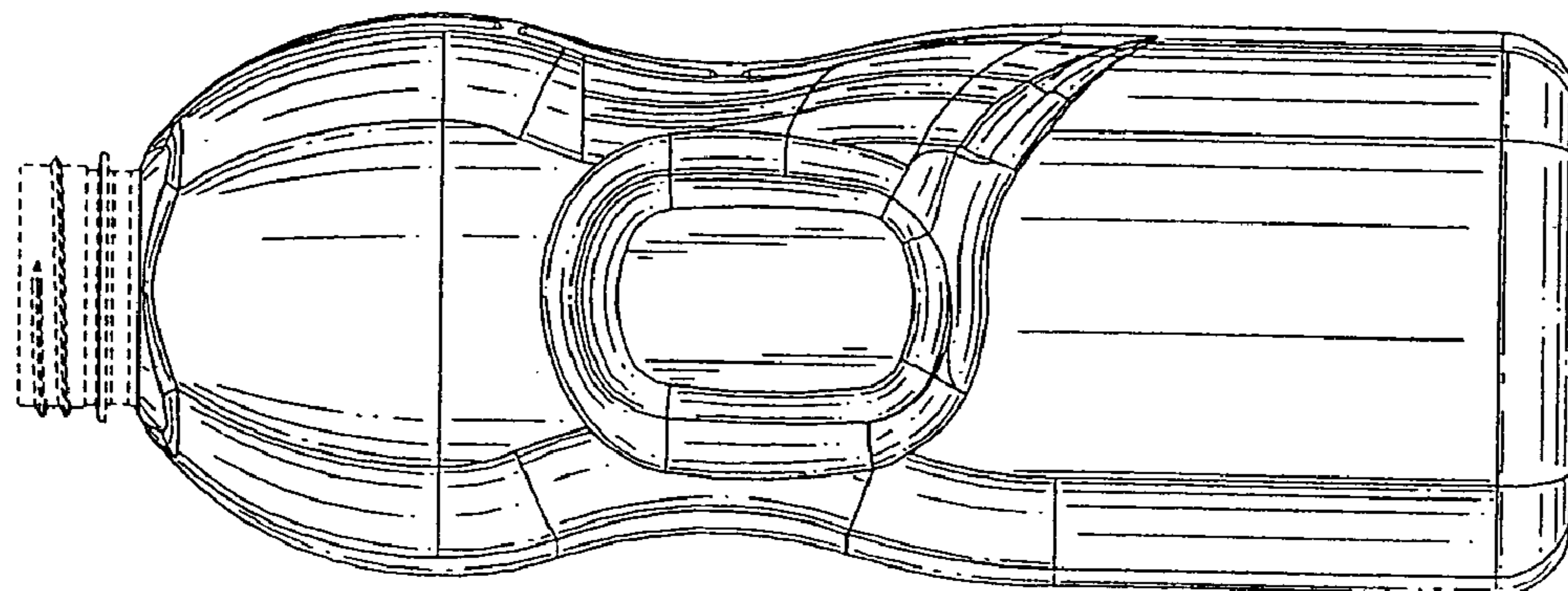

FIG. 8