



US00D583193S

(12) **United States Design Patent**
Kushner

(10) **Patent No.:** **US D583,193 S**

(45) **Date of Patent:** **** Dec. 23, 2008**

(54) **INTERCONNECTING SHOT GLASSES**

(76) **Inventor:** **Robert Gerald Kushner**, Flat G, Block
G Merry Terrace, 4 Seymour Road,
Mid-Levels (HK)

(**) **Term:** **14 Years**

(21) **Appl. No.:** **29/285,169**

(22) **Filed:** **Mar. 21, 2007**

(51) **LOC (8) Cl.** **07-01**

(52) **U.S. Cl.** **D7/513; D7/505; D7/507;**
D7/509

(58) **Field of Classification Search** D7/507,
D7/509, 533, 536, 510, 511, 505, 513; 248/37.6;
215/383; 220/705, 710, 713, 710.5, 735,
220/703, 612; 206/520; 229/400
See application file for complete search history.

(56) **References Cited**

U.S. PATENT DOCUMENTS

2,840,292	A *	6/1958	Stoddard	229/401
3,144,950	A *	8/1964	Rosenheim	215/391
D199,990	S *	1/1965	Wright	D7/315
3,381,849	A *	5/1968	Karlsson	206/520
D214,439	S *	6/1969	Wormeer	D6/335
D218,350	S *	8/1970	Marks	D7/513
D218,471	S *	8/1970	Stone	D7/536
D220,845	S *	6/1971	Mascotti	D7/533
3,700,146	A *	10/1972	Cousins et al.	222/465.1
D225,076	S *	11/1972	Persson	D7/533
D225,792	S *	1/1973	Friesche	D7/533
D261,465	S *	10/1981	Minchew	D7/555
D292,157	S *	10/1987	Robinson	D7/505

D347,547	S *	6/1994	Heinrich	D7/533
D367,413	S *	2/1996	Ballin	D8/34
5,772,065	A *	6/1998	Kalamaras	220/612
D400,402	S *	11/1998	Petkovich, Jr.	D7/549
D447,915	S *	9/2001	Lefroy-Brooks	D7/507
D472,426	S *	4/2003	Premji	D7/513
D551,023	S *	9/2007	Natalino et al.	D7/533
D556,510	S *	12/2007	Meuser	D7/513

* cited by examiner

Primary Examiner—Marianne Pandozzi

(74) *Attorney, Agent, or Firm*—Stuart A. Whittington, Esq.

(57) **CLAIM**

The ornamental design for interconnecting shot glasses, as shown and described.

DESCRIPTION

FIG. 1 is a top plan view of one glass of the interconnecting shot glasses showing my new design with the connectors and other glasses removed for ease of illustration;

FIG. 2 is a side view thereof;

FIG. 3 is a front view thereof;

FIG. 4 is a bottom view thereof;

FIG. 5 is a top view of the connector of the interconnecting shot glasses with the other connectors and glasses removed for ease of illustration;

FIG. 6 is a front view thereof;

FIG. 7 is a side view thereof; and,

FIG. 8 is a top perspective view of interconnecting shot glasses in an assembled state.

1 Claim, 3 Drawing Sheets

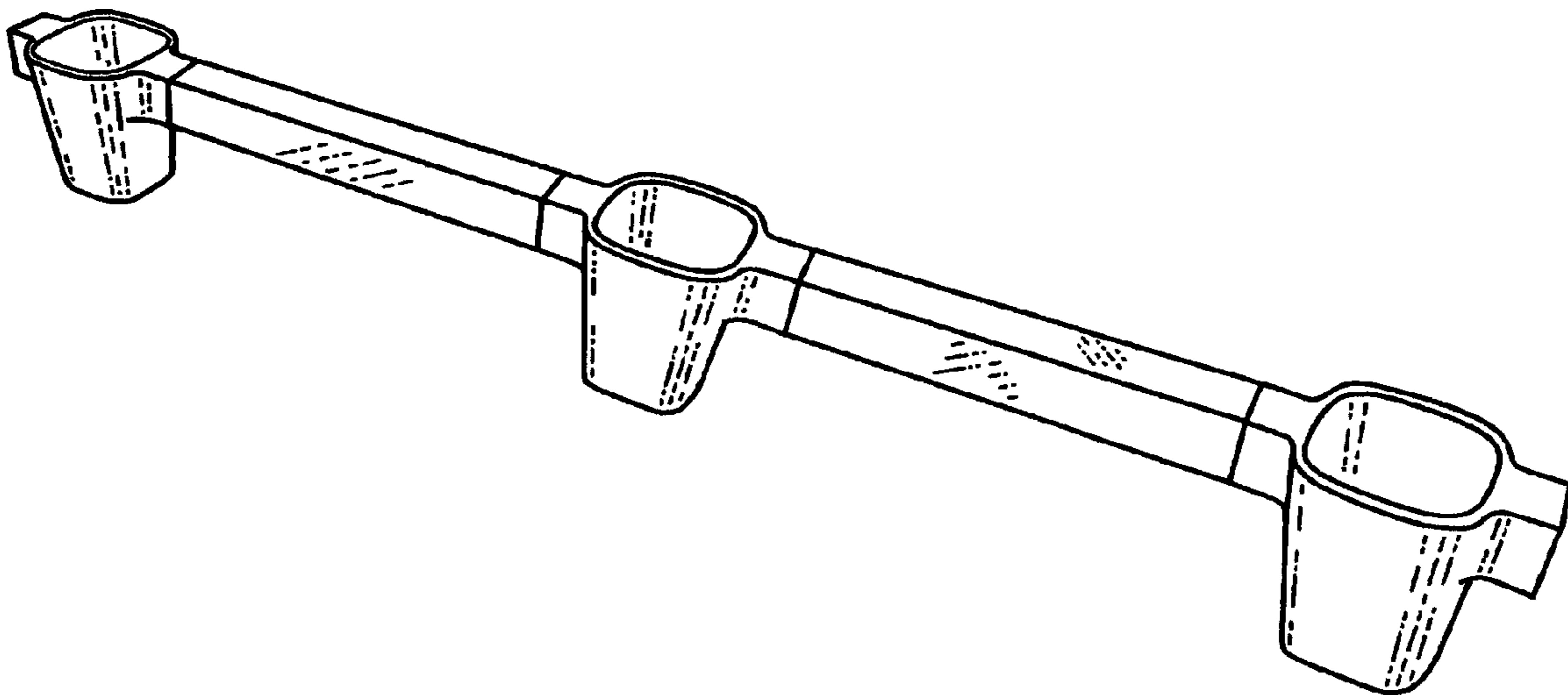

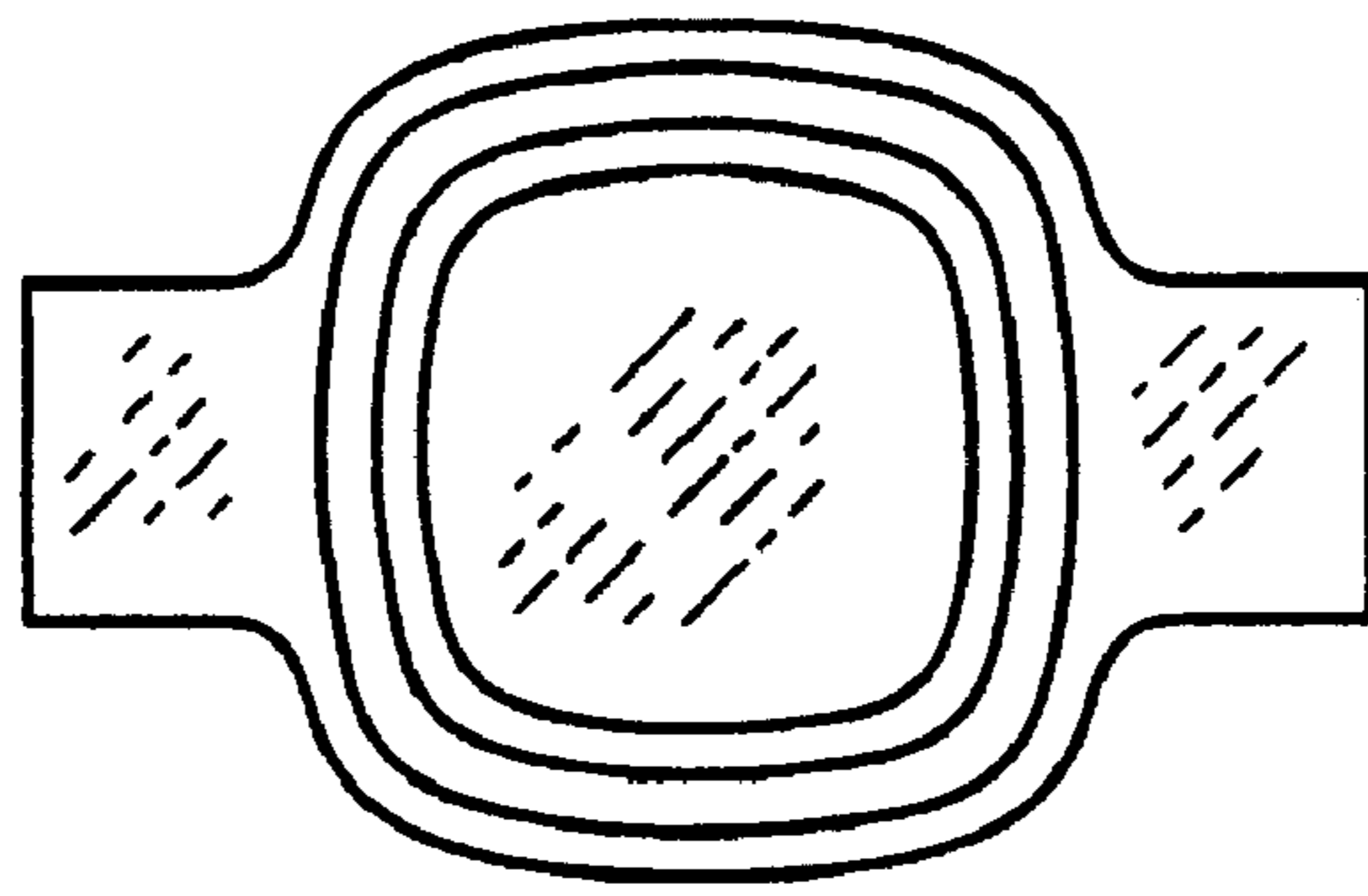

Fig. 1

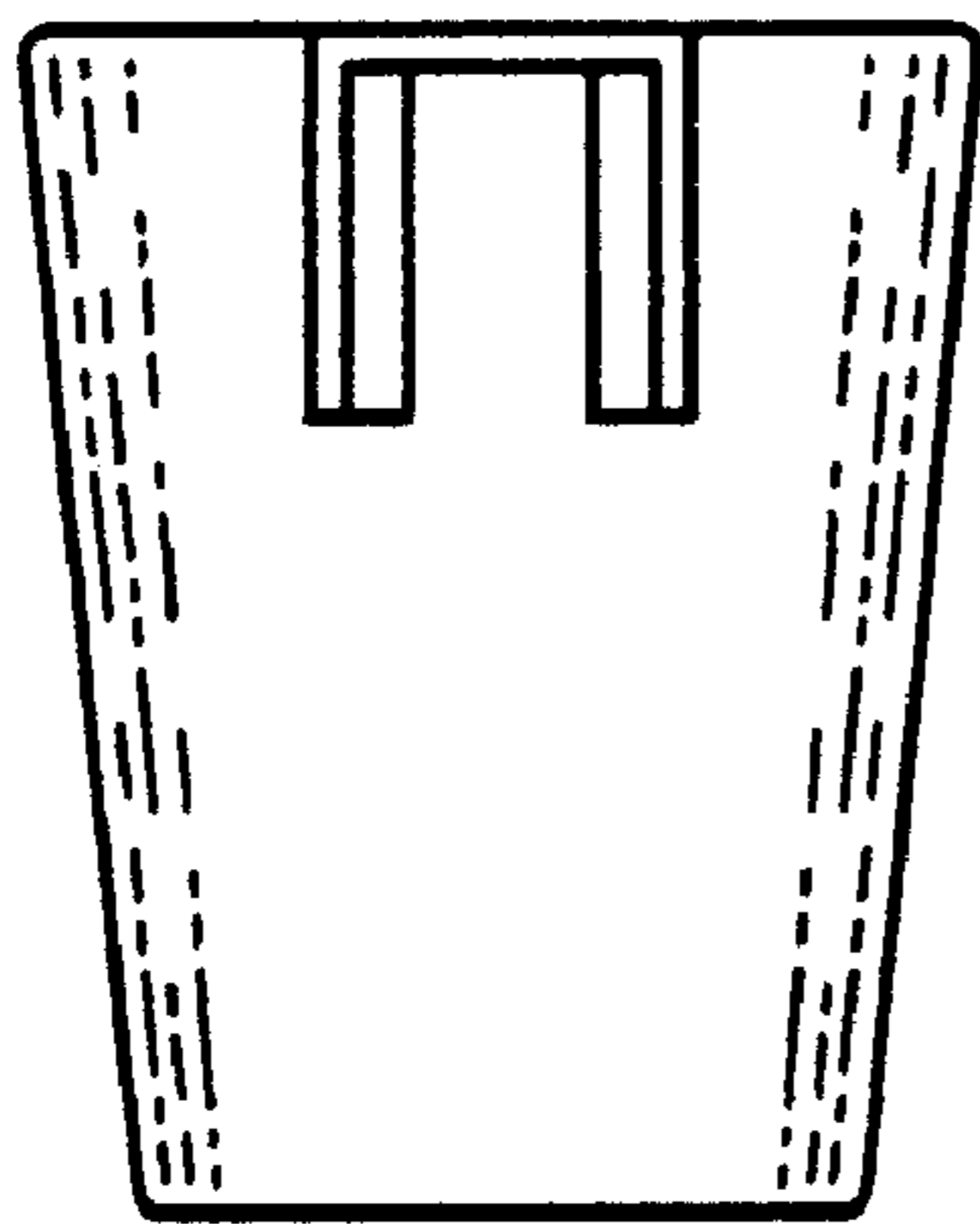

Fig. 2

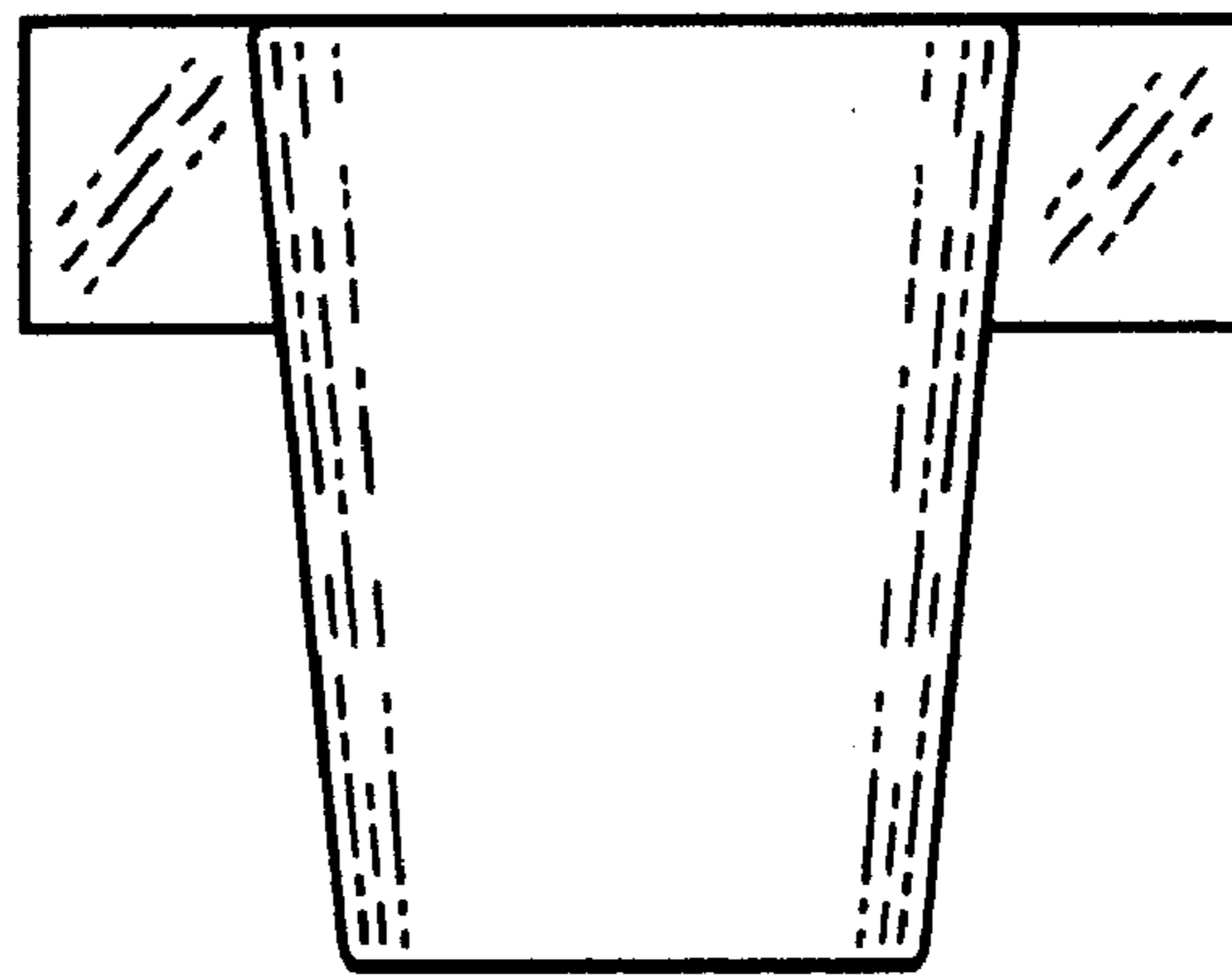

Fig. 3

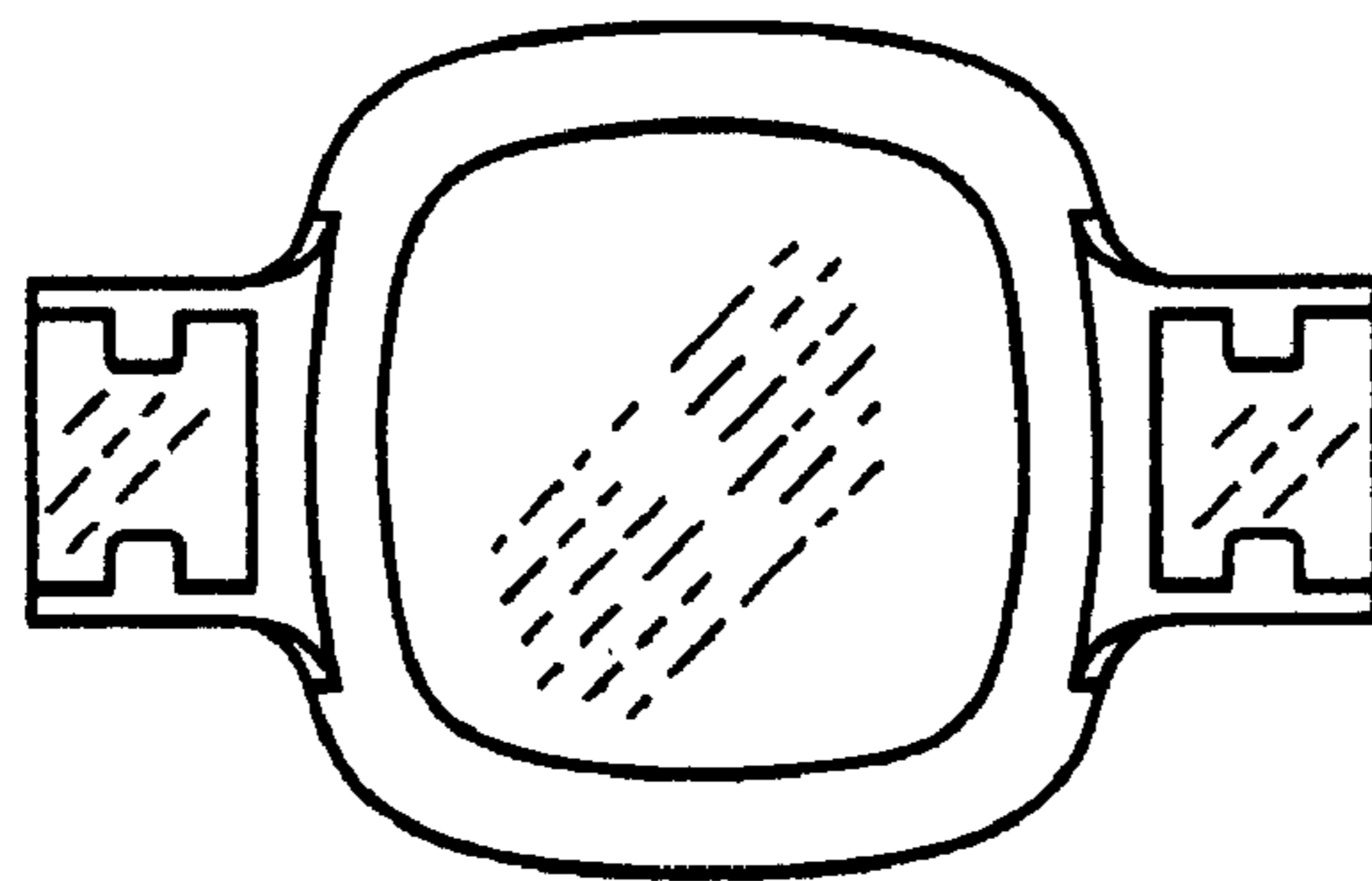

Fig. 4

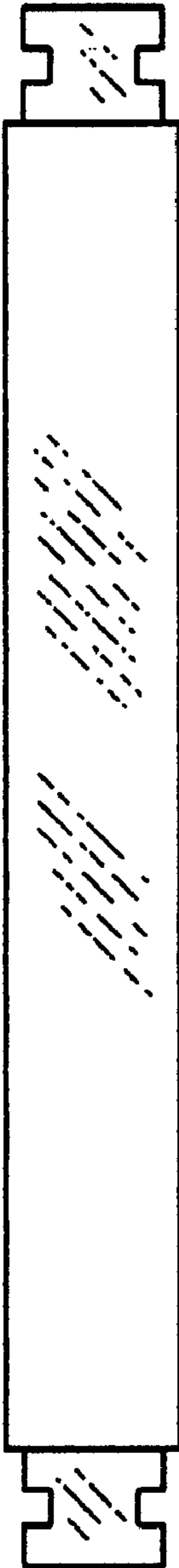

Fig. 5



Fig. 6



Fig. 7

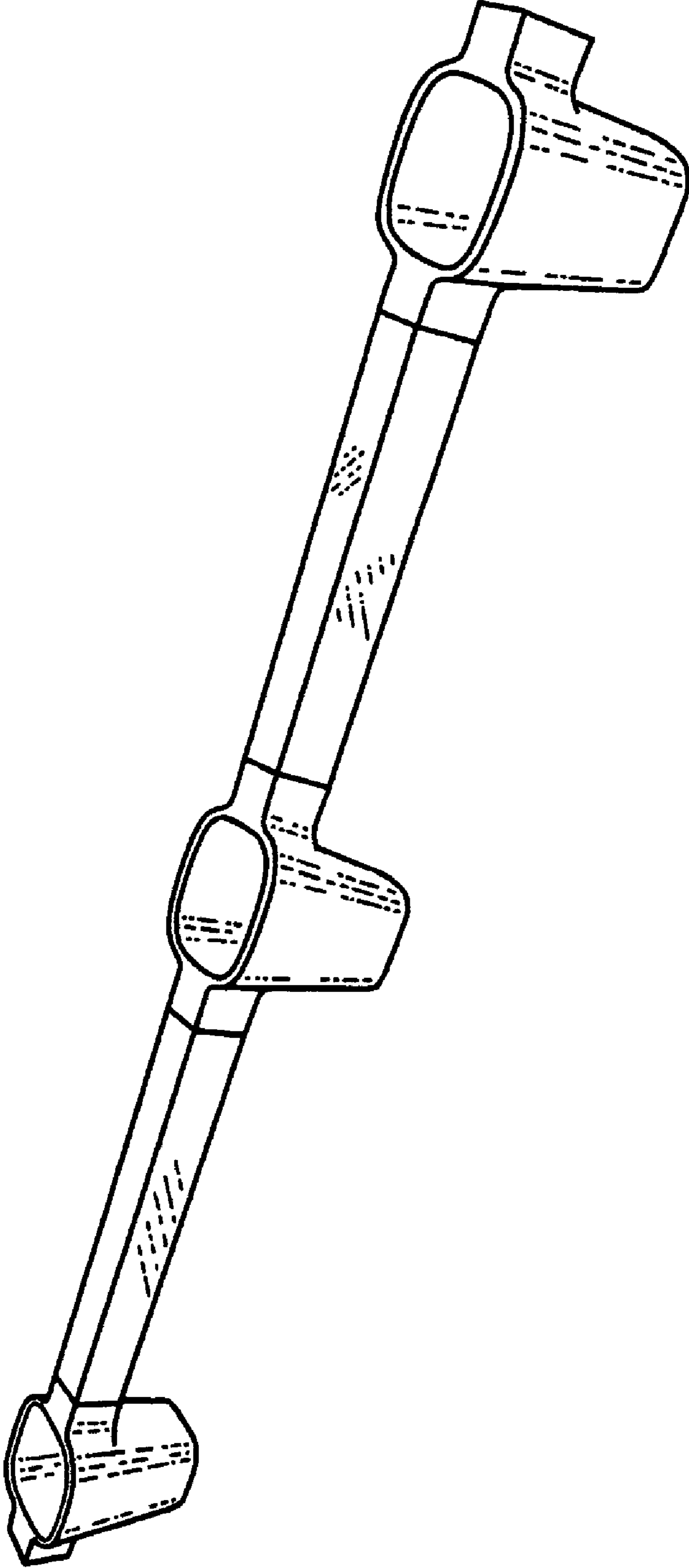

Fig. 8