



US00D583108S

(12) **United States Design Patent**
Richardson

(10) **Patent No.:** **US D583,108 S**

(45) **Date of Patent:** **** Dec. 16, 2008**

(54) **PET CARRIER**

(75) Inventor: **Jed Richardson**, Batavia, IL (US)

(73) Assignee: **Suncast Technologies, LLC**, Palm Beach Gardens, FL (US)

(**) Term: **14 Years**

(21) Appl. No.: **29/297,280**

(22) Filed: **Nov. 8, 2007**

(51) **LOC (8) Cl.** **30-02**

(52) **U.S. Cl.** **D30/109**

(58) **Field of Classification Search** D30/108-117;
119/52.3, 416-417, 421, 446, 452-453, 499
See application file for complete search history.

(56) **References Cited**

U.S. PATENT DOCUMENTS

4,256,056	A *	3/1981	Sou	119/497
4,484,540	A *	11/1984	Yamamoto	119/497
D308,429	S *	6/1990	VanSkiver	D30/109
5,357,900	A *	10/1994	Ho	119/497
D367,733	S *	3/1996	Paxman et al.	D30/109
5,967,090	A *	10/1999	Hui	119/497
D443,958	S *	6/2001	Chrisco et al.	D30/109
6,539,895	B2 *	4/2003	Hoagland	119/453
6,571,740	B1 *	6/2003	Kinder et al.	119/497
7,201,116	B2 *	4/2007	Axelrod	119/499
D545,004	S *	6/2007	Harper et al.	D30/108
D545,507	S *	6/2007	Harper et al.	D30/108
D546,005	S *	7/2007	Harper et al.	D30/108

D555,292	S *	11/2007	Harper et al.	D30/108
D570,556	S *	6/2008	Richardson	D30/109
D571,053	S *	6/2008	Donnelly	D30/108
D574,559	S *	8/2008	You et al.	D30/109
2005/0284404	A1 *	12/2005	Pomakoy-Poole et al.	...	119/497

* cited by examiner

Primary Examiner—Cathy Anne MacCormac

(74) *Attorney, Agent, or Firm*—McHale & Slavin, P.A.

(57) **CLAIM**

The ornamental design for a pet carrier, as shown and described.

DESCRIPTION

FIG. 1 is a front perspective view of the pet carrier of the instant invention;

FIG. 2 is a rear perspective view thereof;

FIG. 3 is a bottom perspective view thereof;

FIG. 4 is a front view thereof;

FIG. 5 is a rear view thereof;

FIG. 6 is a left side view thereof;

FIG. 7 is a right side view thereof;

FIG. 8 is a top view thereof; and,

FIG. 9 is a bottom view thereof.

The broken lines are for purposes of illustration only and form no part of the claimed design.

1 Claim, 9 Drawing Sheets

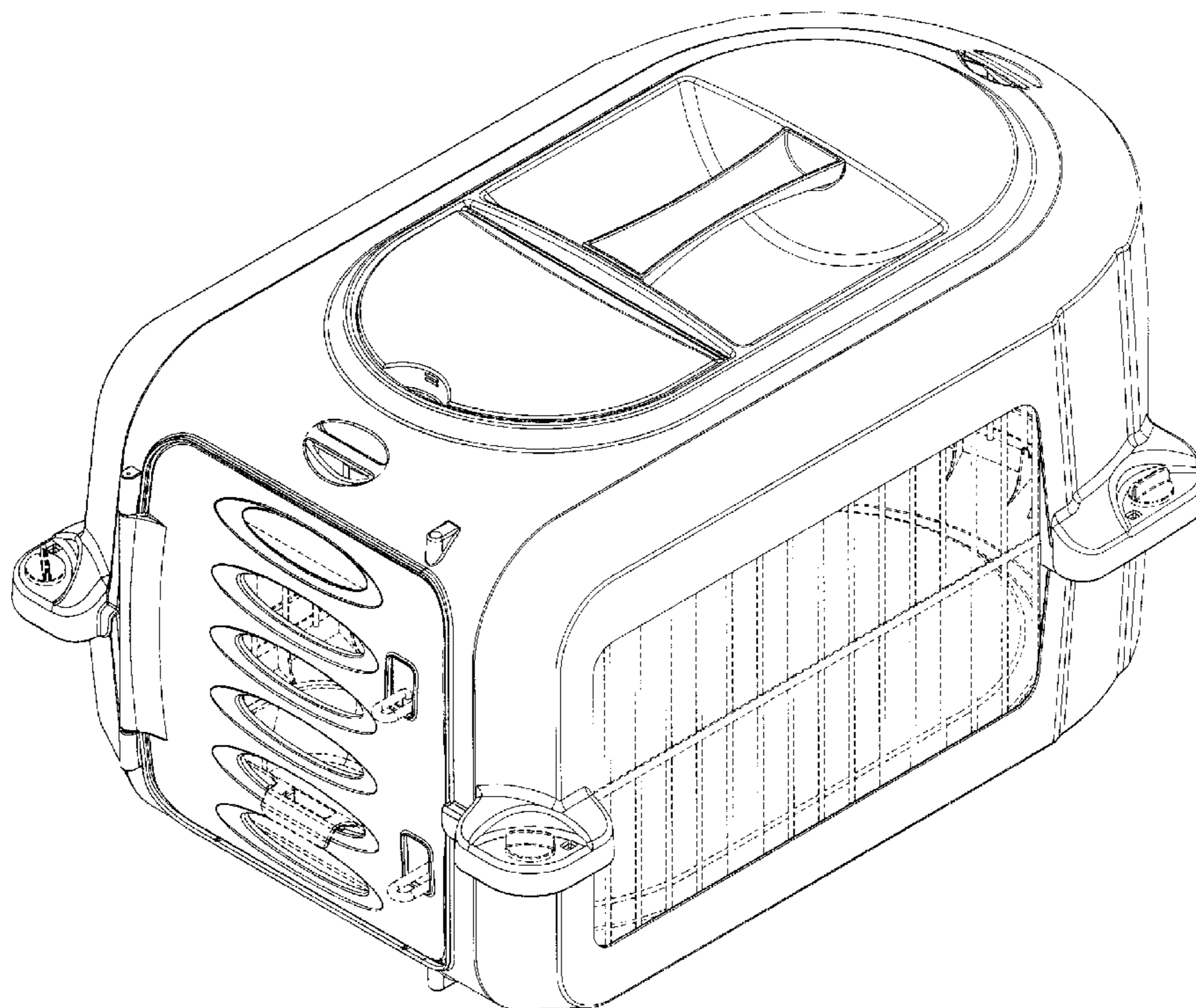

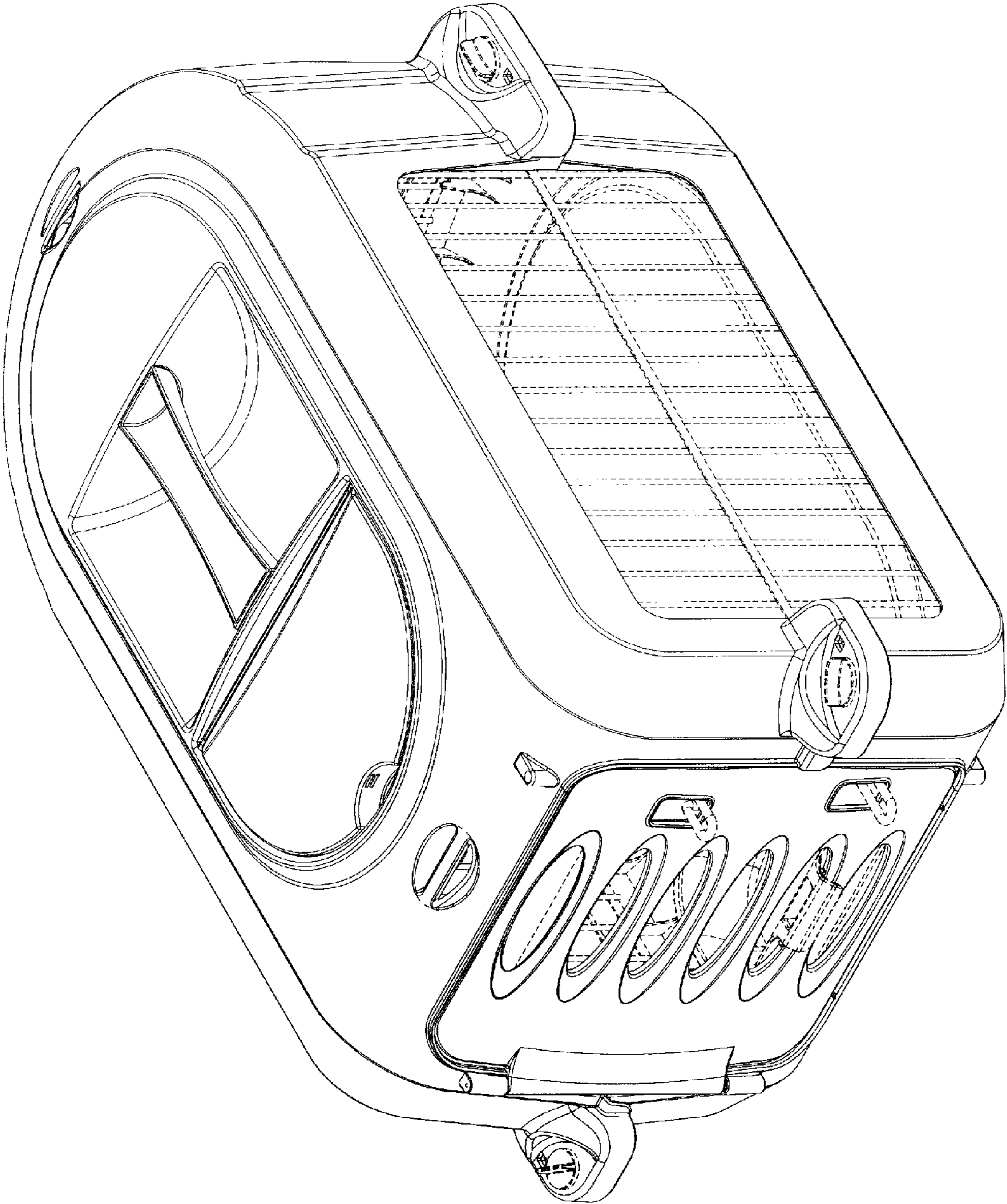

Fig. 1

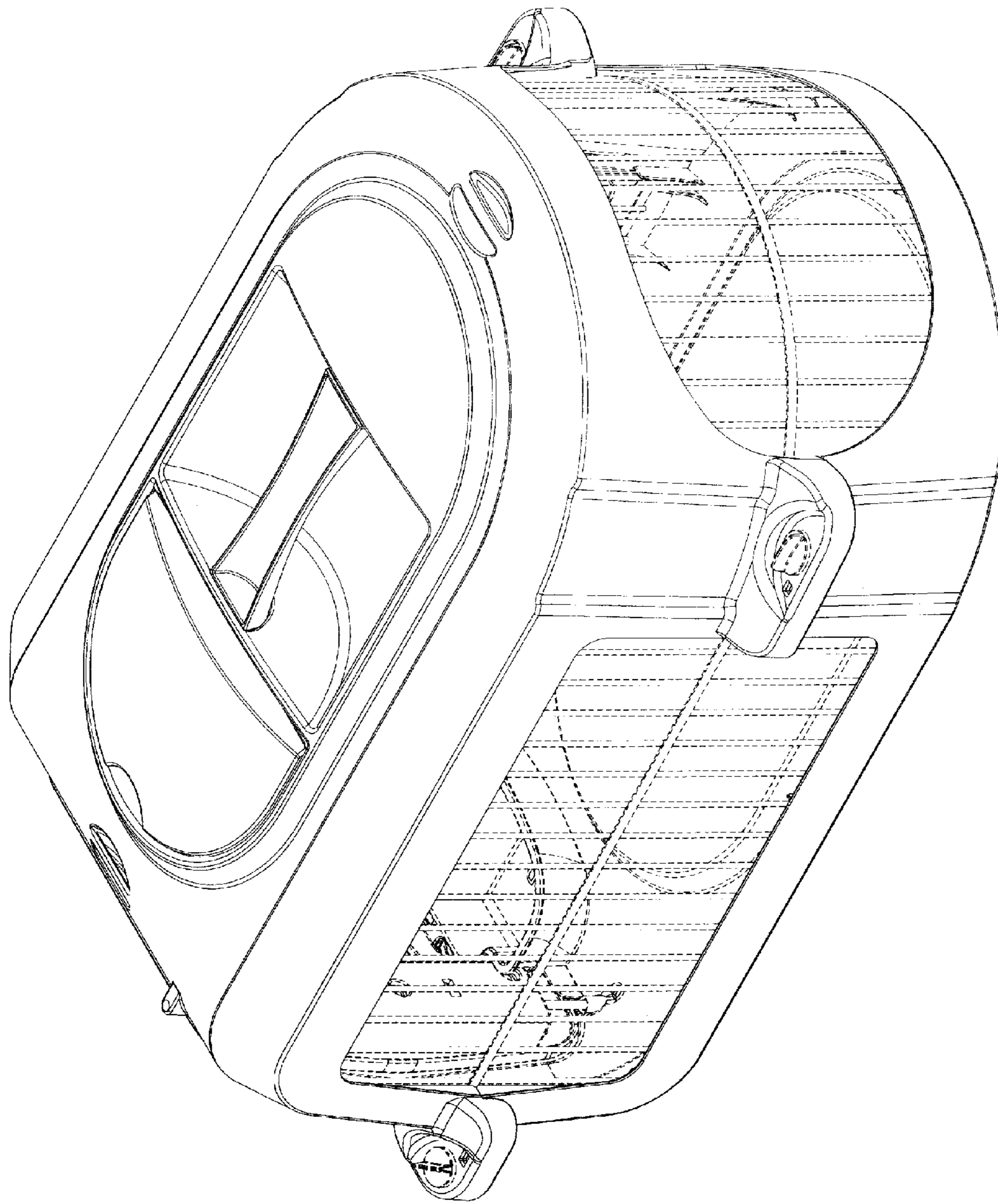

Fig. 2

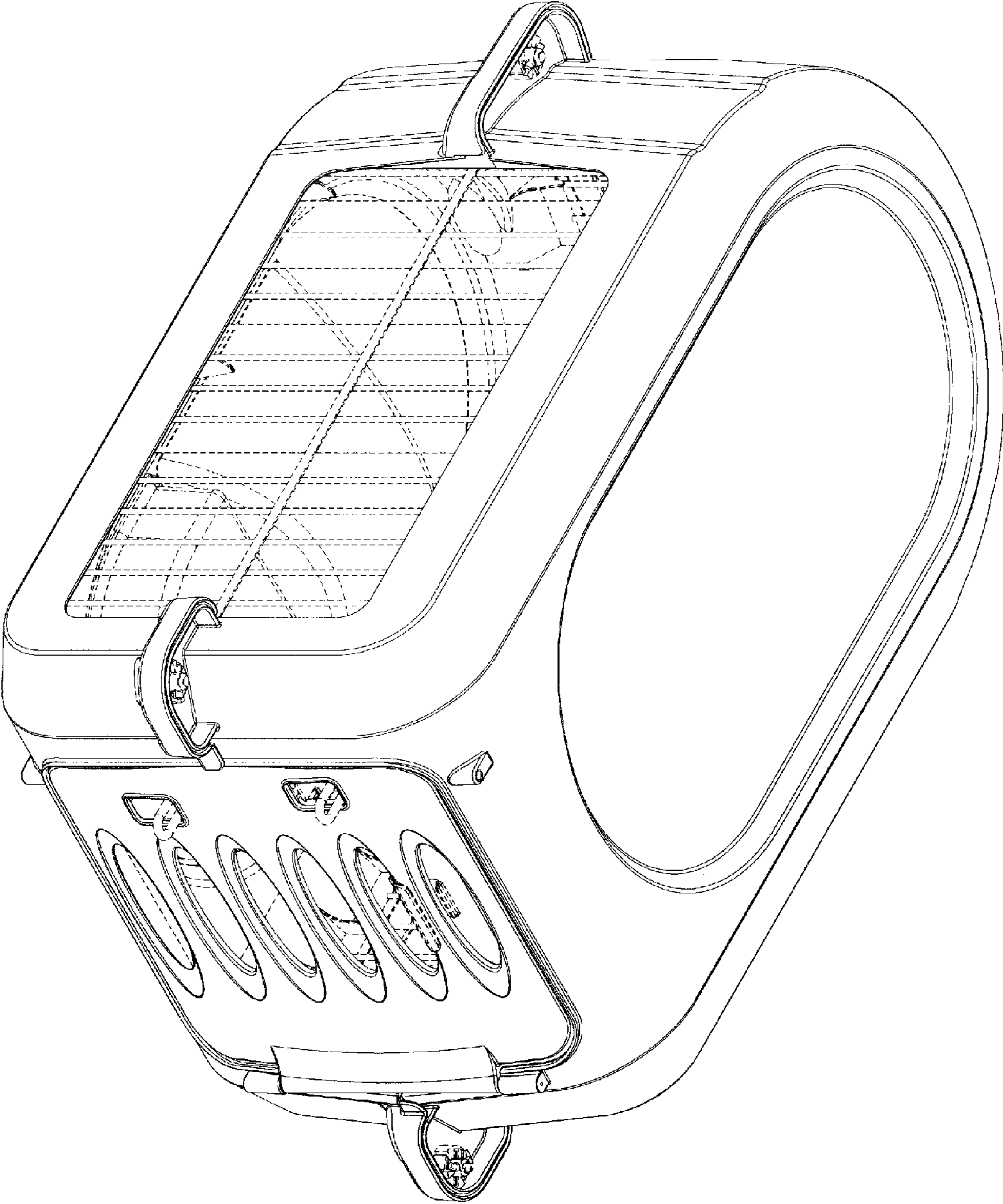

Fig. 3

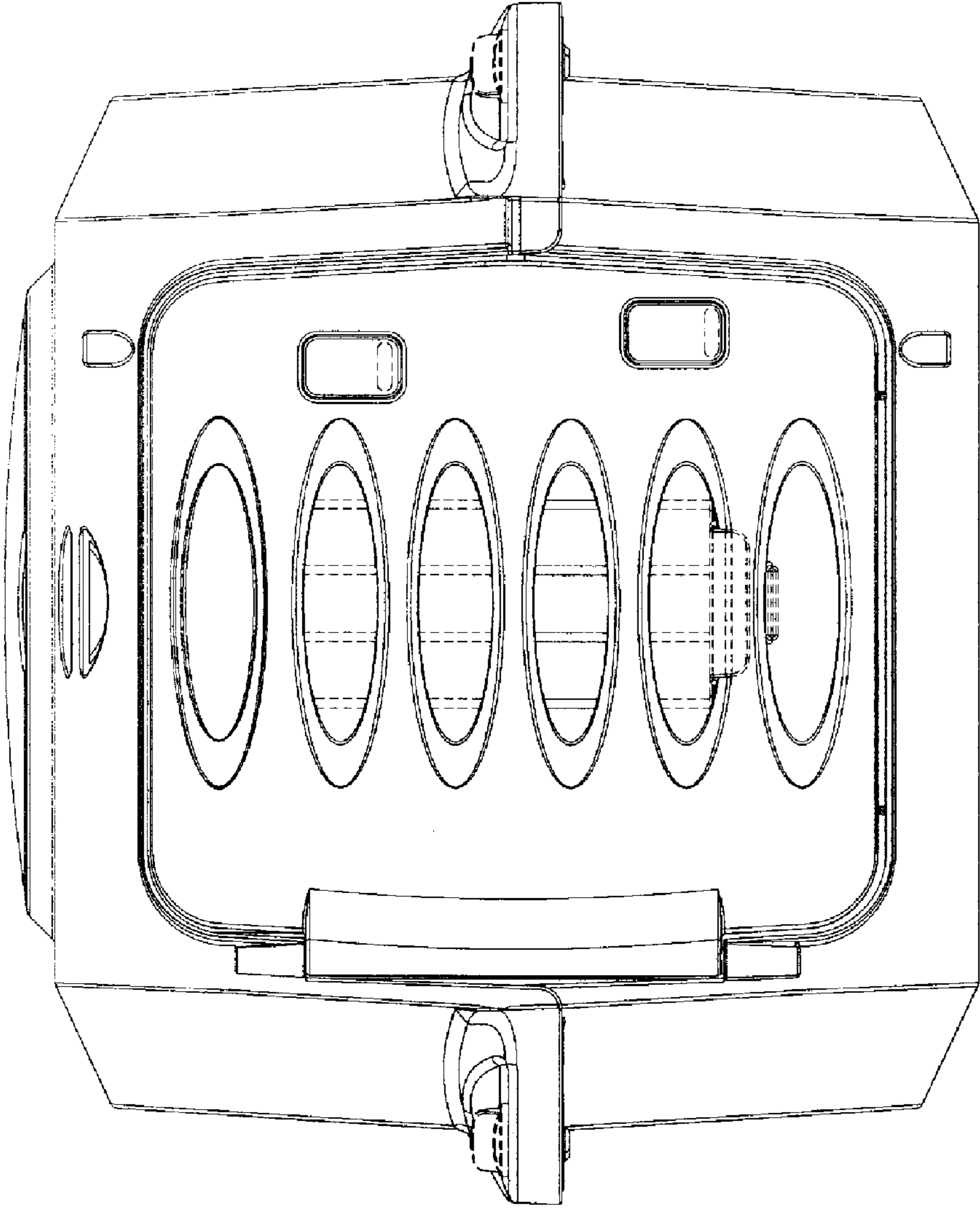

Fig. 4

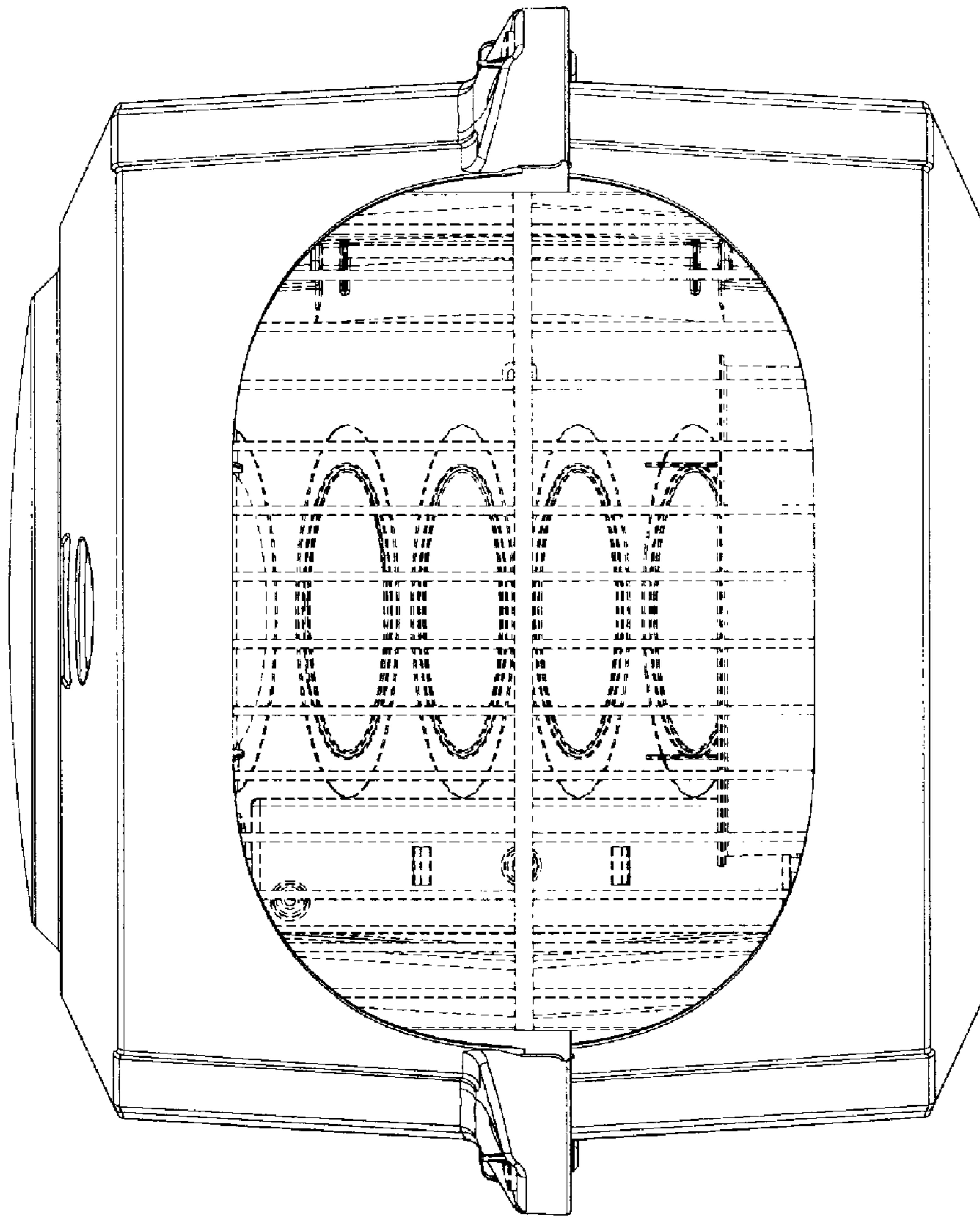

Fig. 5

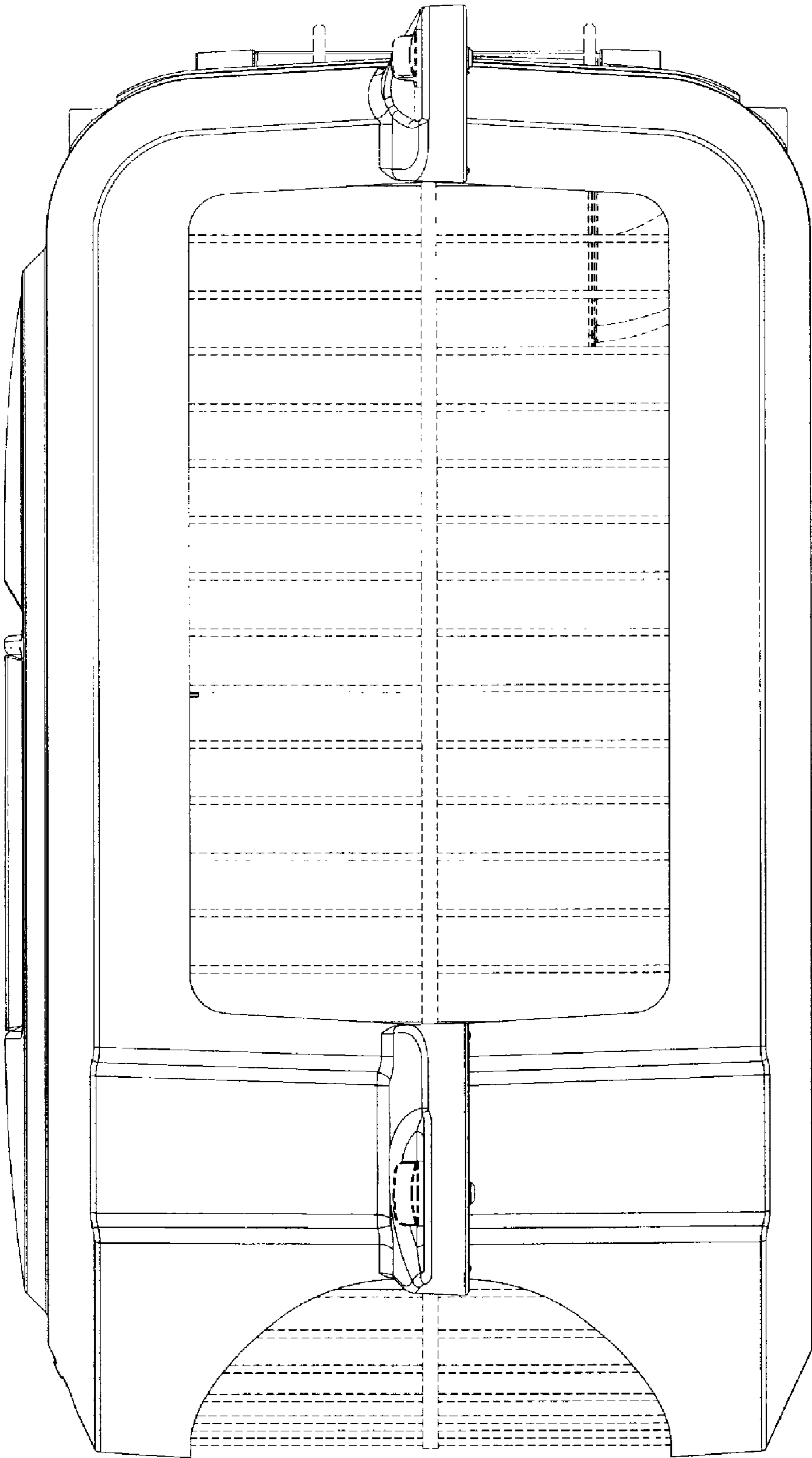

Fig. 6

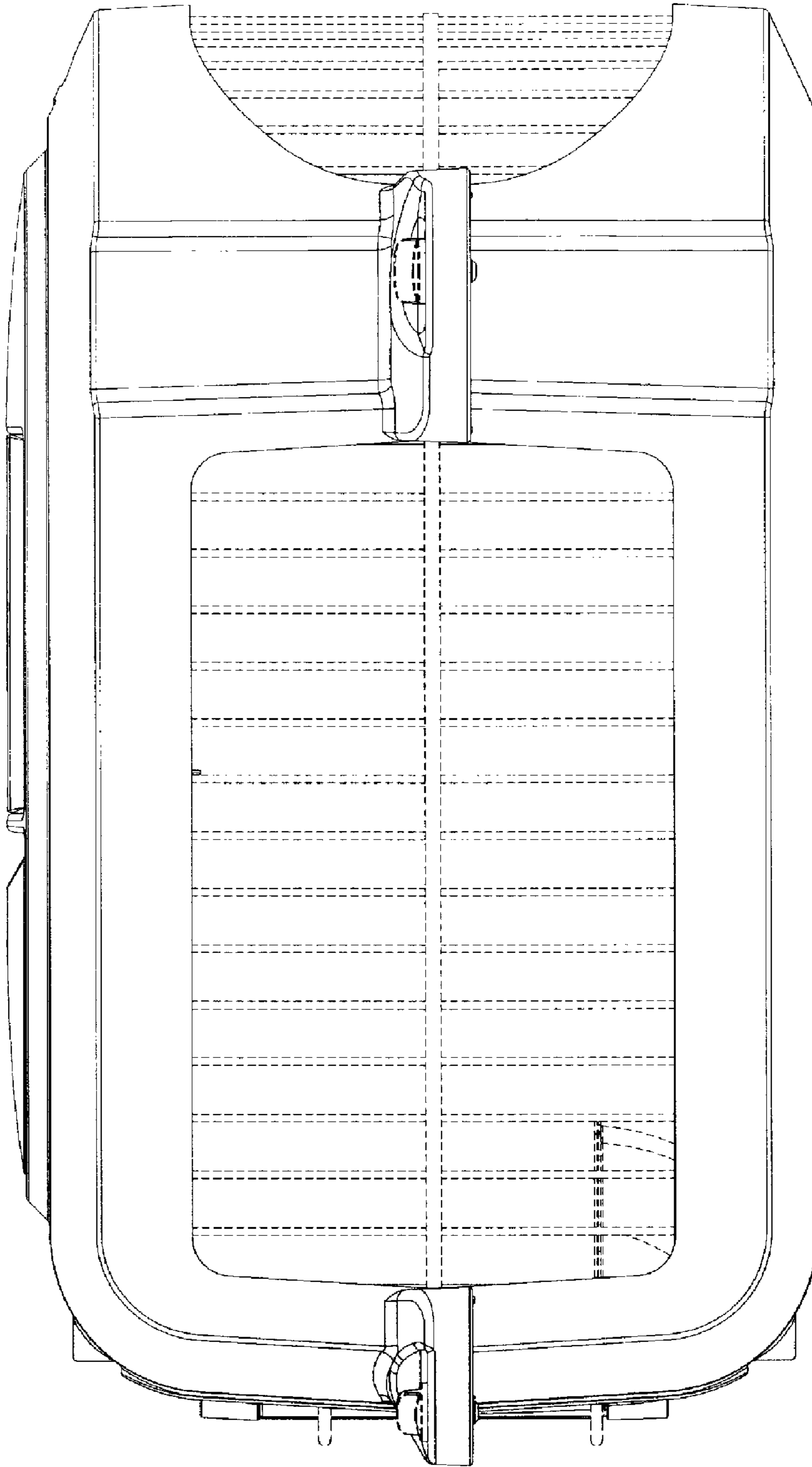

Fig. 7

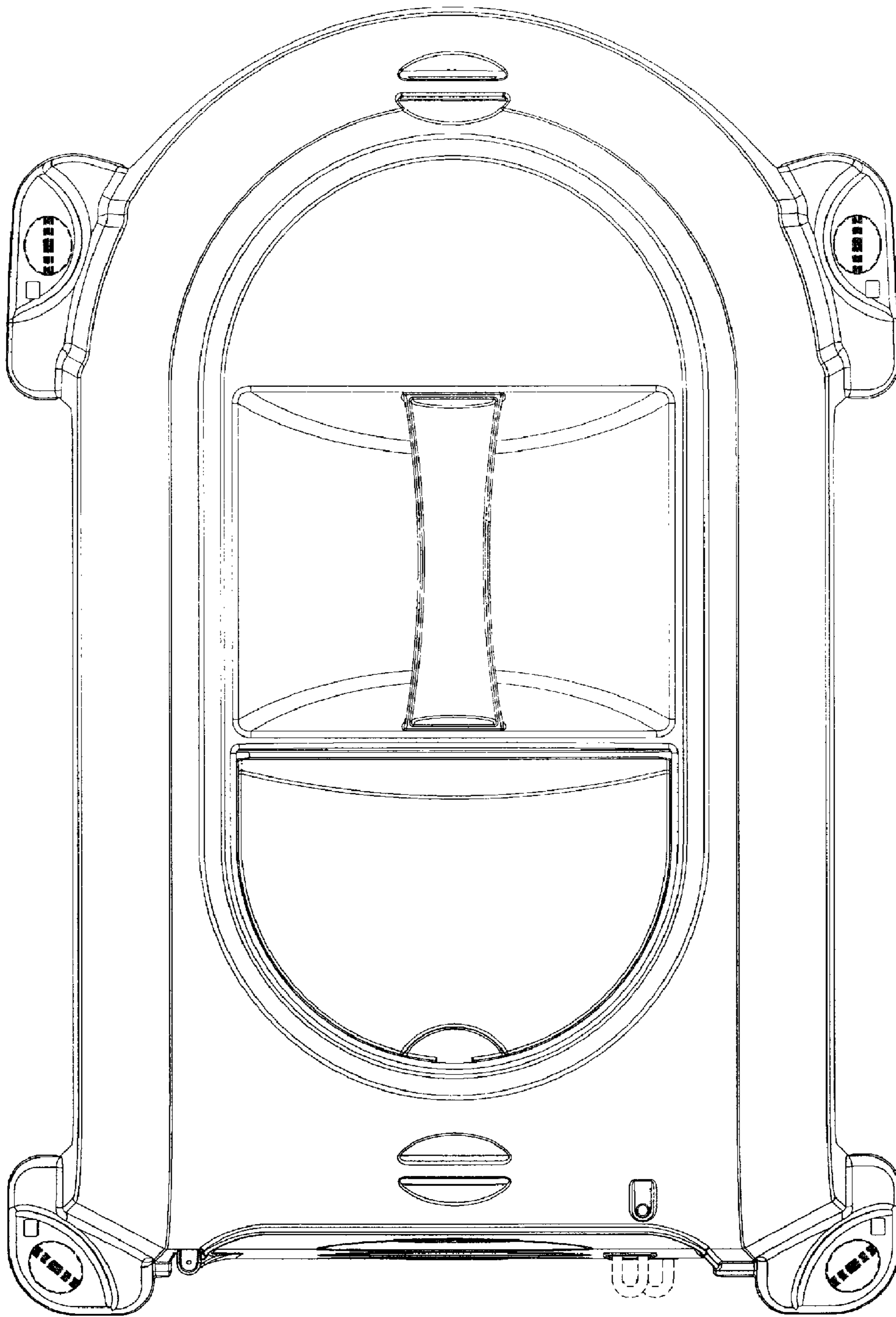

Fig. 8

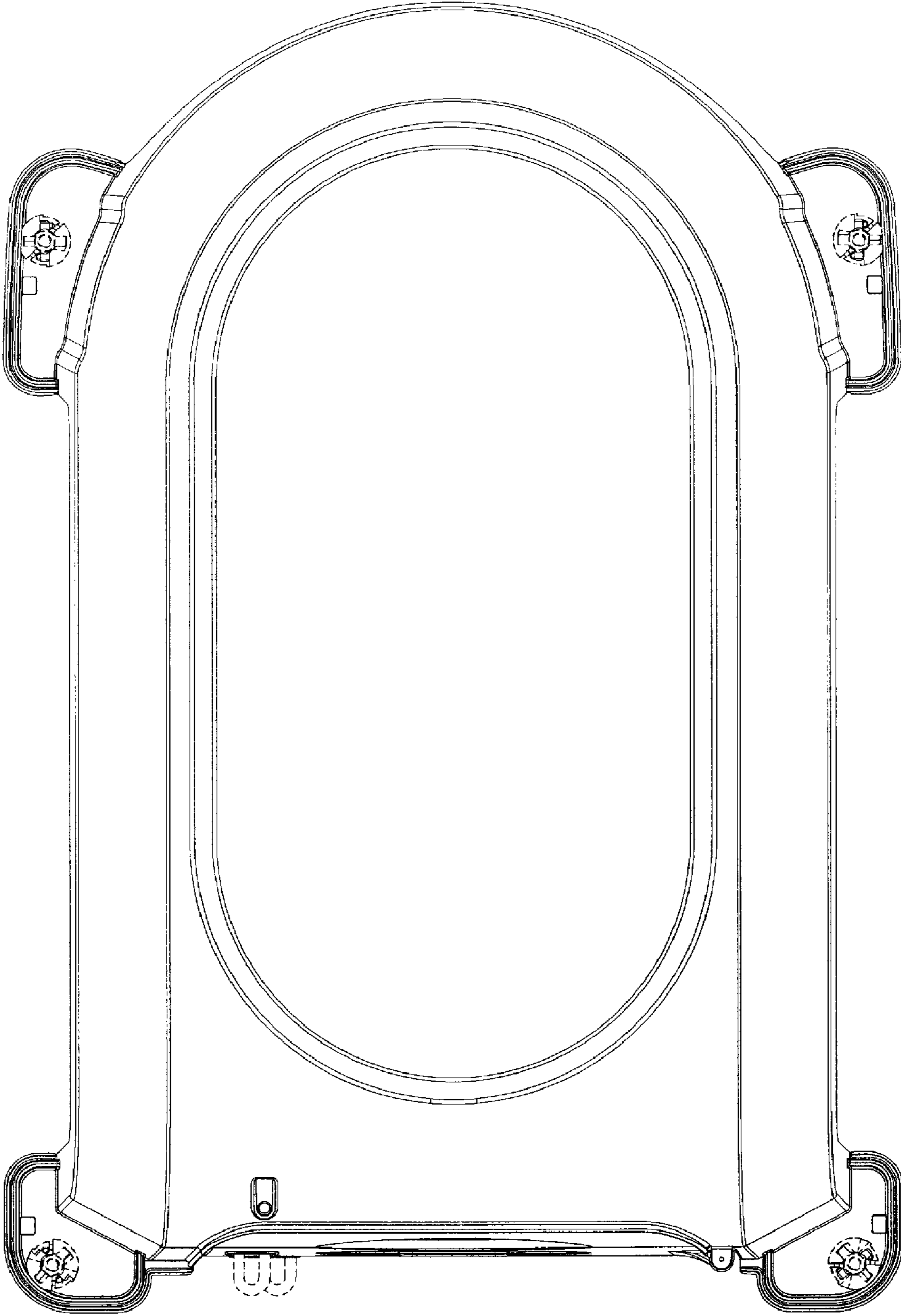

Fig. 9