



US00D582999S

(12) **United States Design Patent**
Evans et al.

(10) **Patent No.:** **US D582,999 S**
(45) **Date of Patent:** **** Dec. 16, 2008**

(54) **TIP END OF A GOLF CLUB SHAFT**

(75) Inventors: **D. Clayton Evans**, San Marcos, CA (US); **Matthew T. Cackett**, San Diego, CA (US); **J. Neil Hall**, Carlsbad, CA (US); **Brandon D. Demille**, Encinitas, CA (US); **Alan Hocknell**, Carlsbad, CA (US)

(73) Assignee: **Callaway Golf Company**, Carlsbad, CA (US)

(**) Term: **14 Years**

(21) Appl. No.: **29/299,497**

(22) Filed: **Dec. 27, 2007**

(51) **LOC (8) Cl.** **21-02**

(52) **U.S. Cl.** **D21/759**

(58) **Field of Classification Search** D21/753,
D21/759, 756, 757; 473/300–323

See application file for complete search history.

(56) **References Cited**

U.S. PATENT DOCUMENTS

5,324,033	A *	6/1994	Fenton, Jr.	473/305
D393,678	S *	4/1998	Jones et al.	D21/759
D434,822	S *	12/2000	Jacobson et al.	D21/759
6,352,482	B1 *	3/2002	Jacobson et al.	473/310
6,547,673	B2 *	4/2003	Roark	473/239
6,620,053	B2 *	9/2003	Tseng	473/297
6,769,996	B2 *	8/2004	Tseng	473/306
7,083,529	B2 *	8/2006	Cackett et al.	473/309
D537,896	S *	3/2007	Holt et al.	D21/759
2004/0018887	A1 *	1/2004	Burrows	473/307

* cited by examiner

Primary Examiner—Mitchell I Siegel

(74) *Attorney, Agent, or Firm*—Michael A. Catania; Elaine H. Lo

(57) **CLAIM**

The ornamental design for a tip end of a golf club shaft, as shown and described.

DESCRIPTION

FIG. 1 is a bottom perspective view of a portion of a tip end of a golf club shaft;

FIG. 2 is an additional bottom perspective view of a portion of a tip end of a golf club shaft rotated slightly from the position in FIG. 1;

FIG. 3 is a top perspective view of a portion of a tip end of a golf club shaft;

FIG. 4 is an additional top perspective view of a portion of a tip end of a golf club shaft rotated slightly from the position in FIG. 3;

FIG. 5 is a perspective view of a portion of a tip end of a golf club shaft looking down the shaft;

FIG. 6 is a front elevational view a portion of a tip end of a golf club shaft;

FIG. 7 is a front elevational view a portion of a tip end of a golf club shaft rotated slightly from the position in FIG. 6;

FIG. 8 is a front elevational view a portion of a tip end of a golf club shaft rotated slightly from the position in FIG. 7; and,

FIG. 9 is bottom plan view of a portion of a tip end of a golf club shaft.

The broken line showing of the fragmented shaft on FIGS. 1–8 is included for the purpose of illustrating and forms no part of the claimed design.

1 Claim, 3 Drawing Sheets

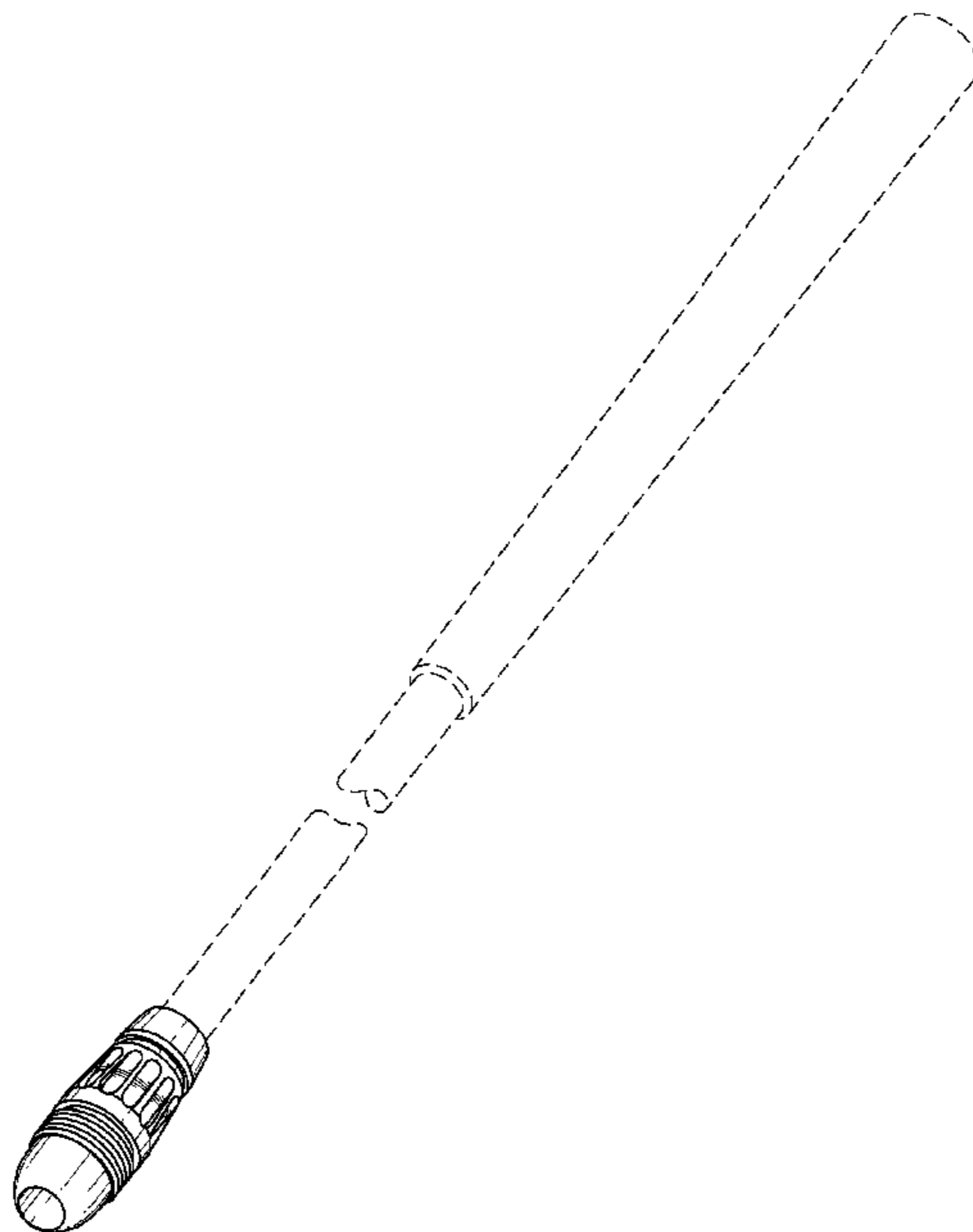

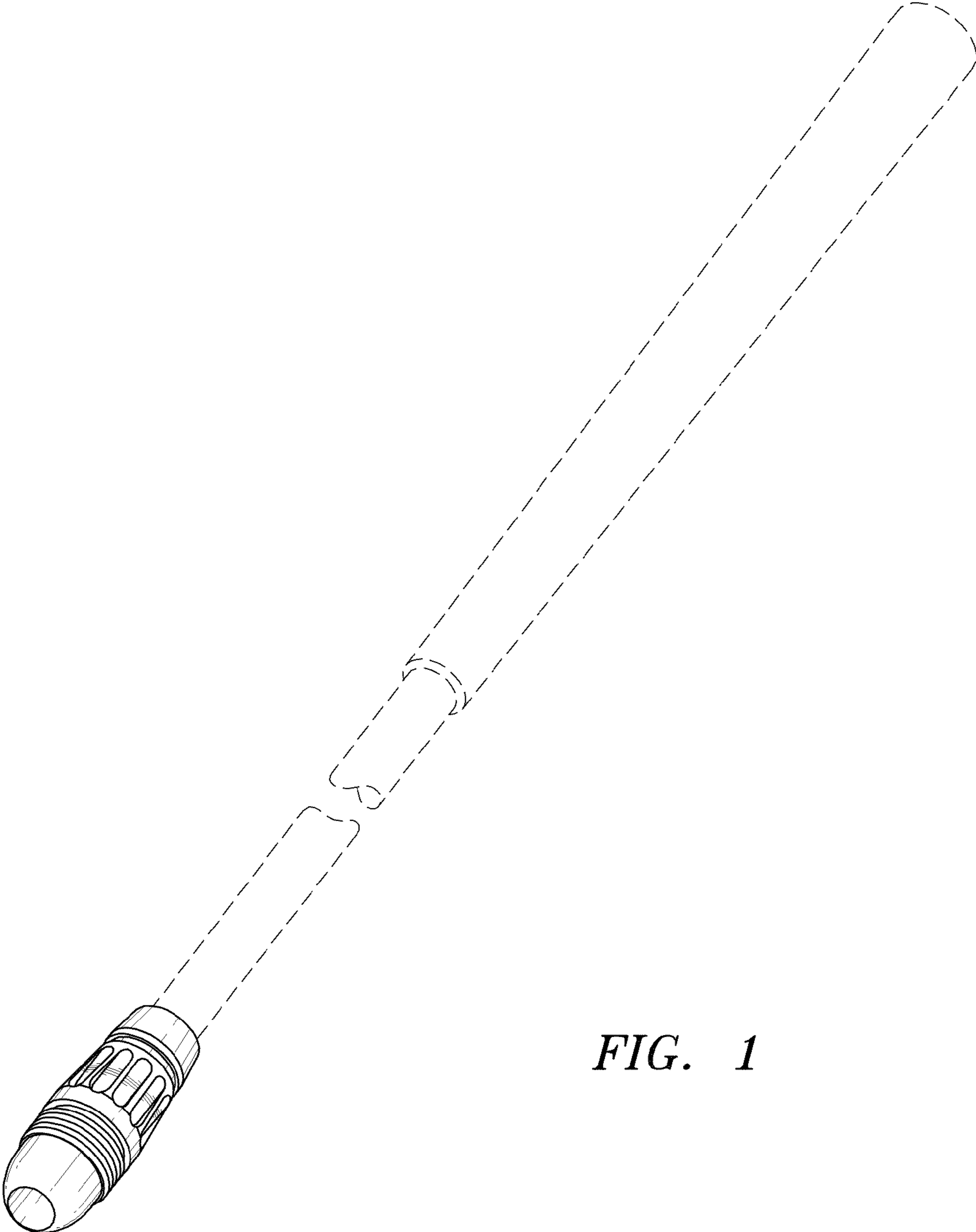

FIG. 1

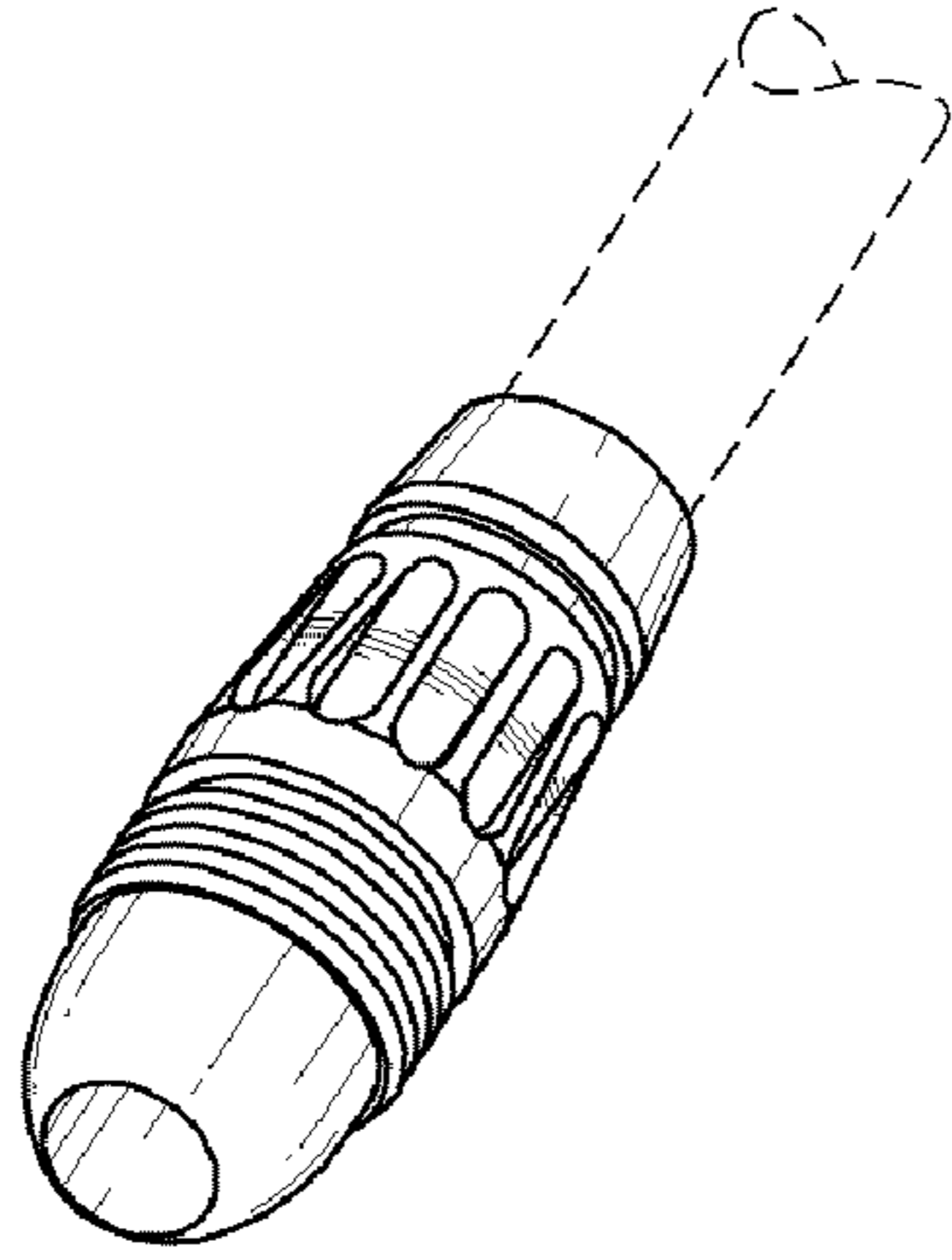

FIG. 2

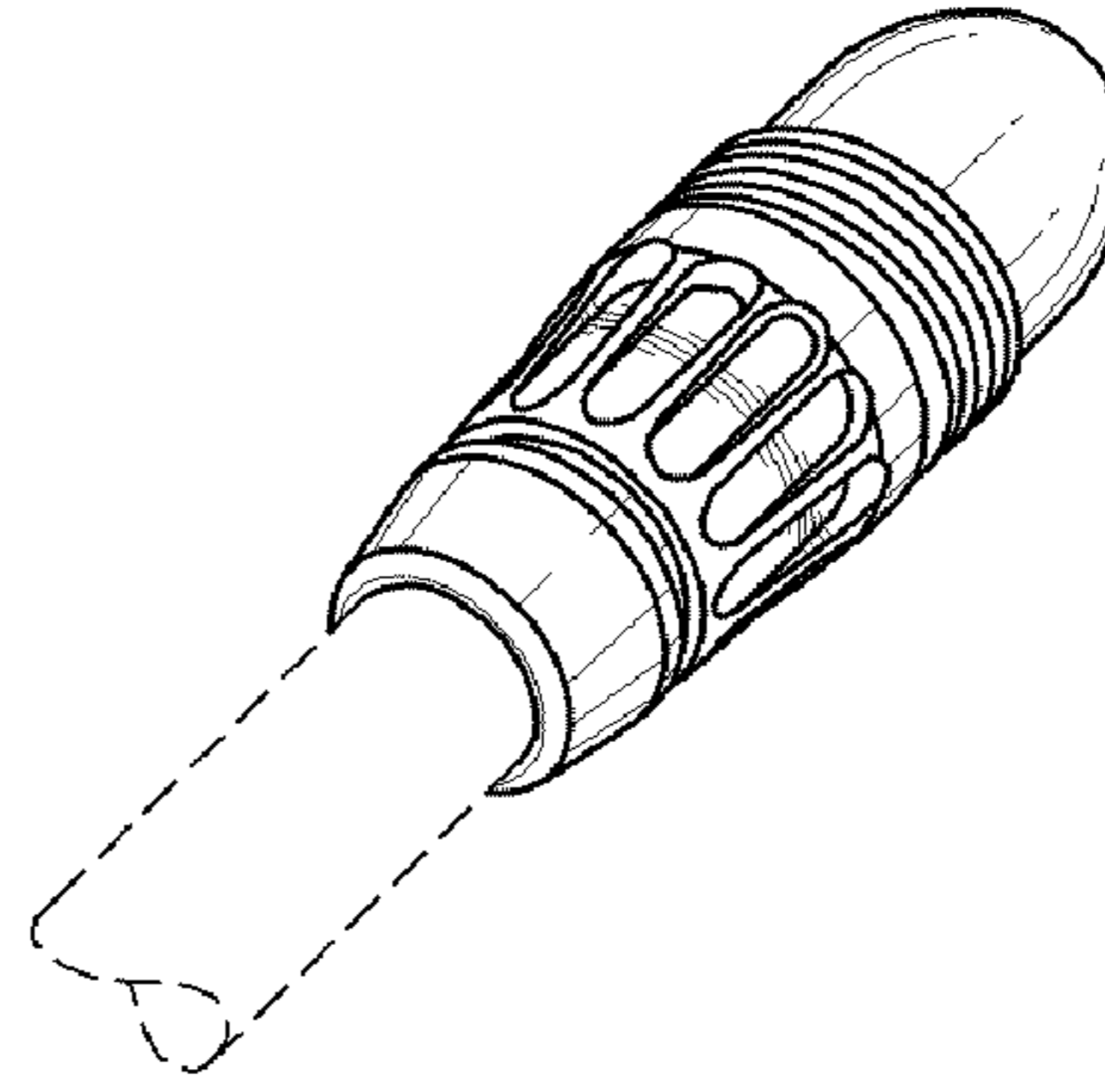

FIG. 3

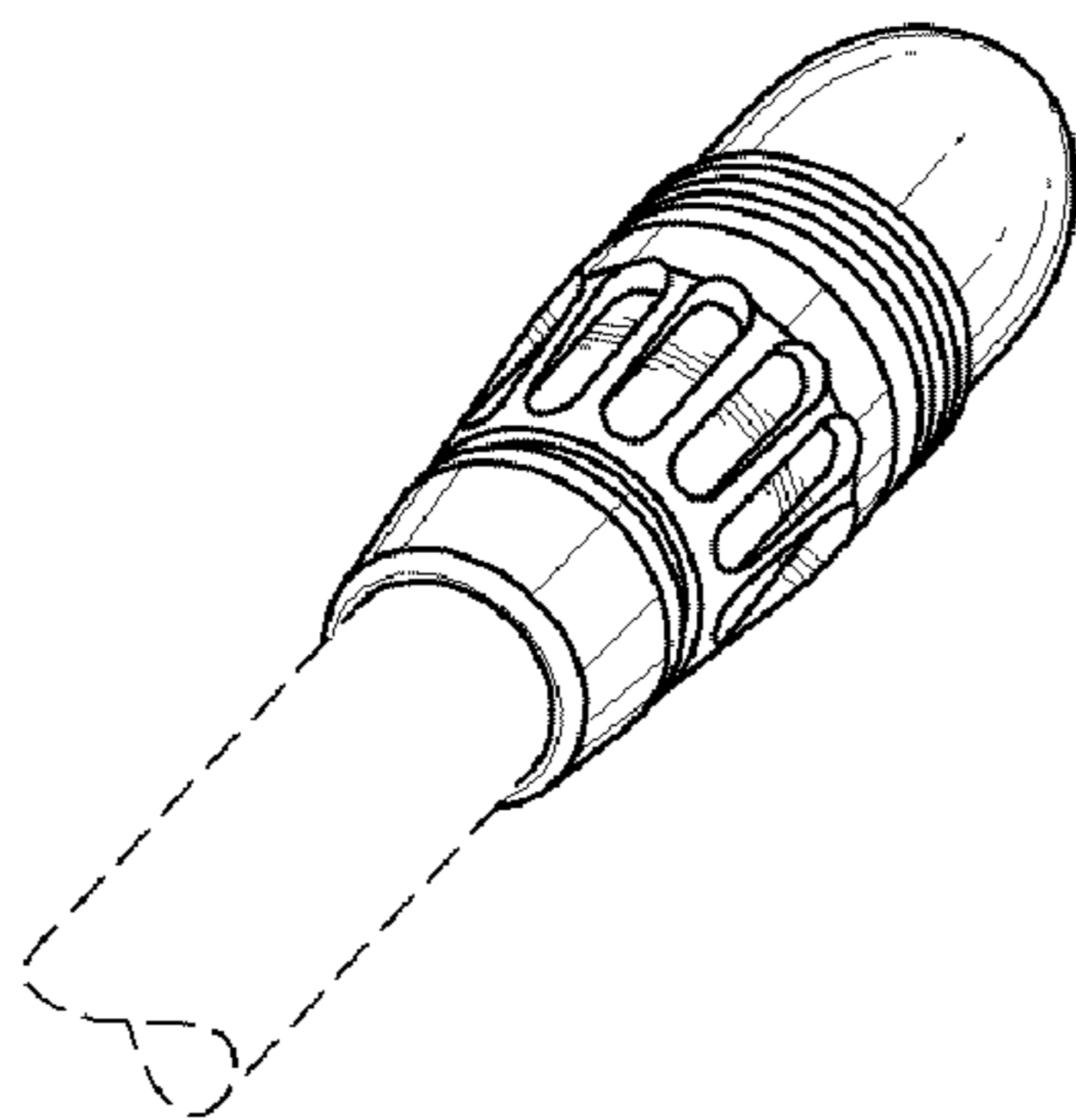

FIG. 4

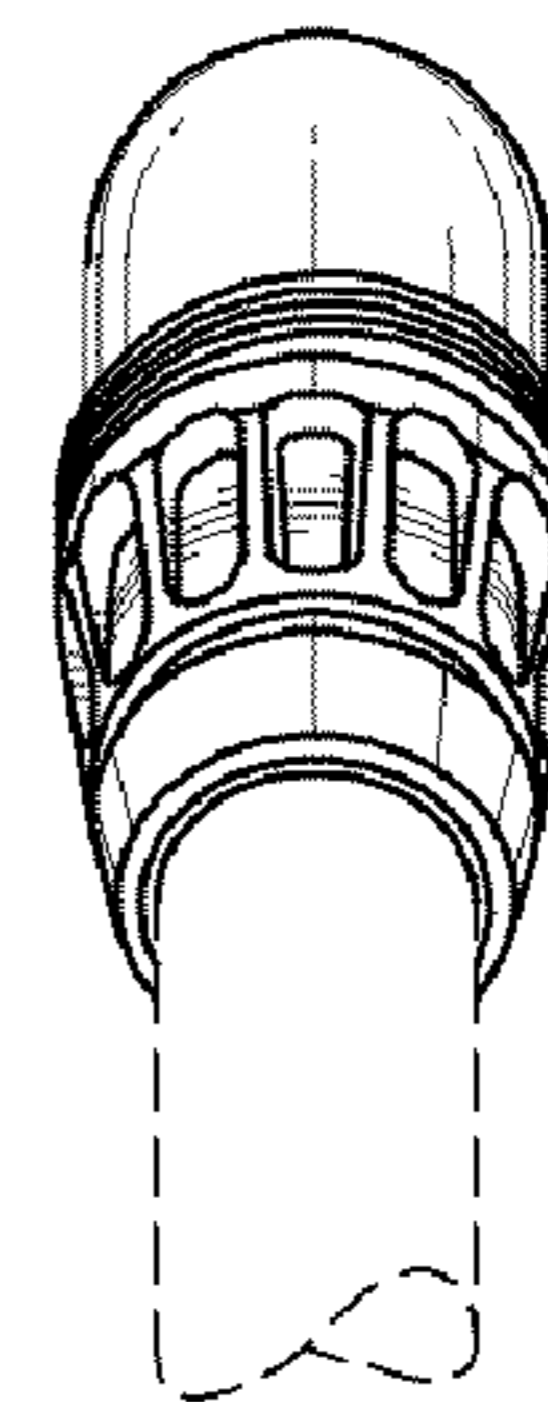

FIG. 5

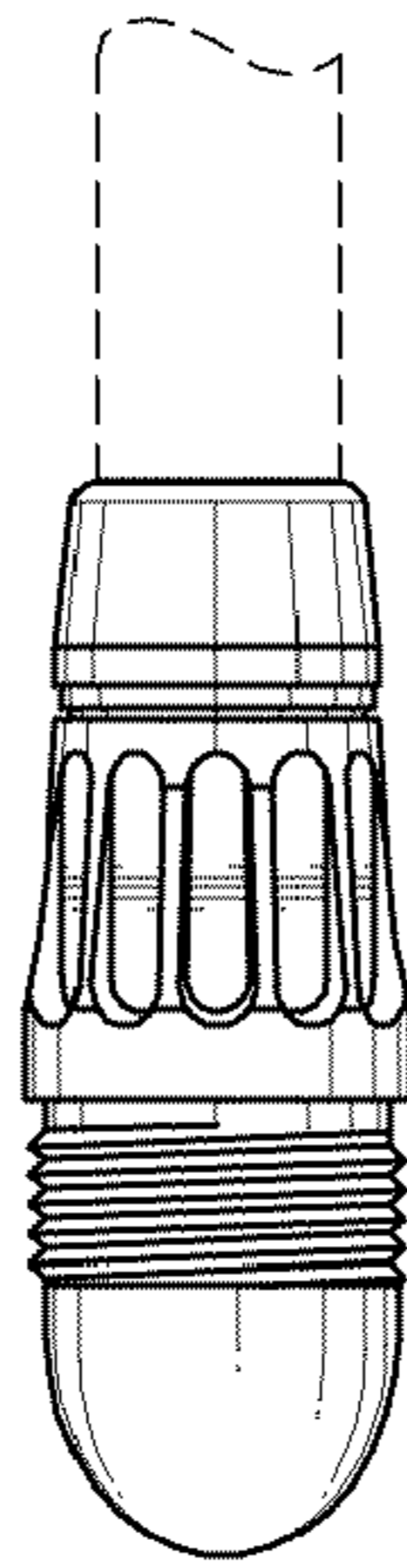

FIG. 6

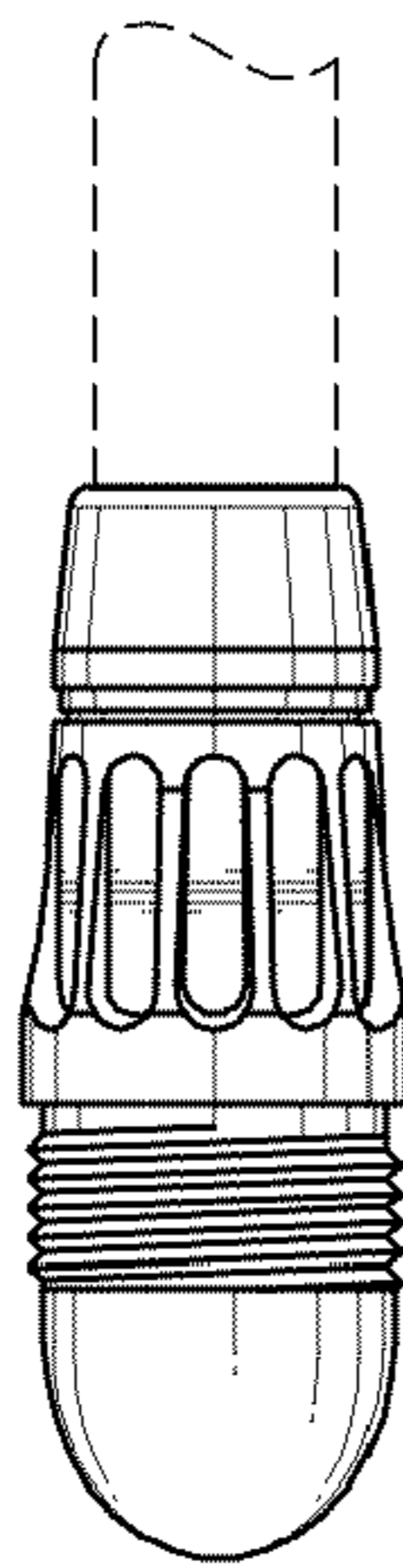

FIG. 7

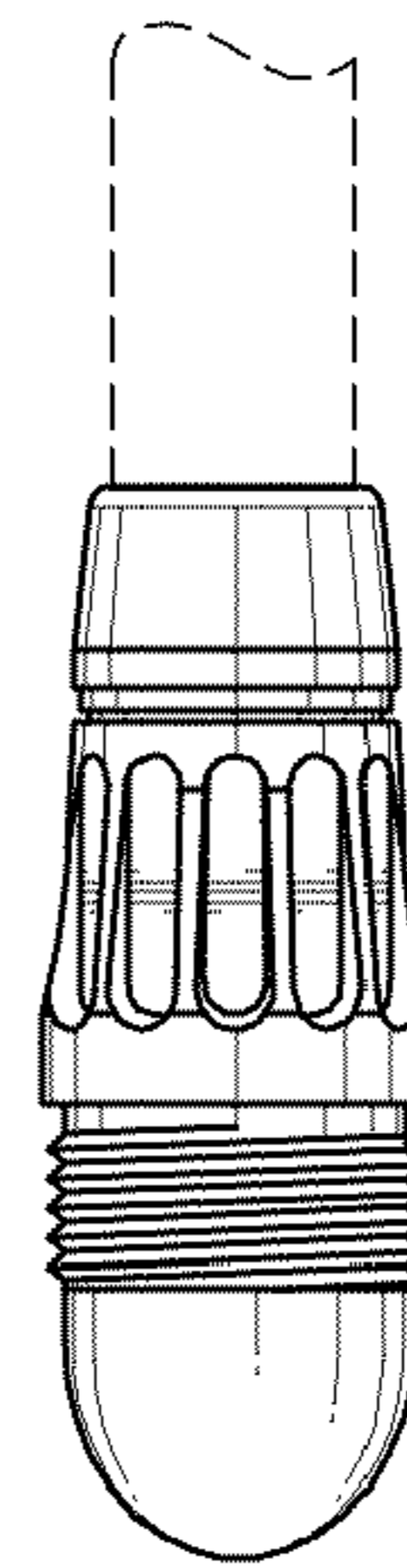

FIG. 8

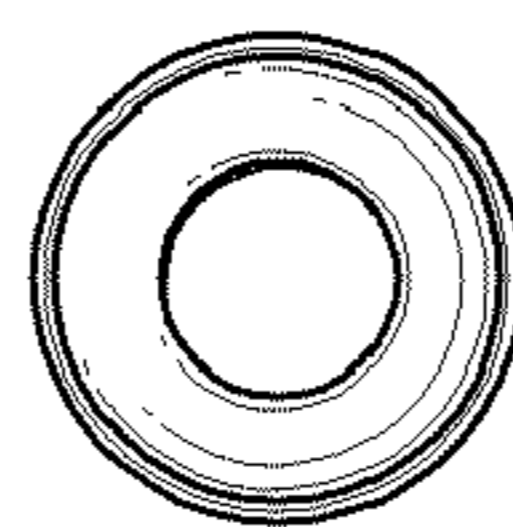

FIG. 9